

INTERNATIONAL
GNSS SERVICE

Technical Report

2011

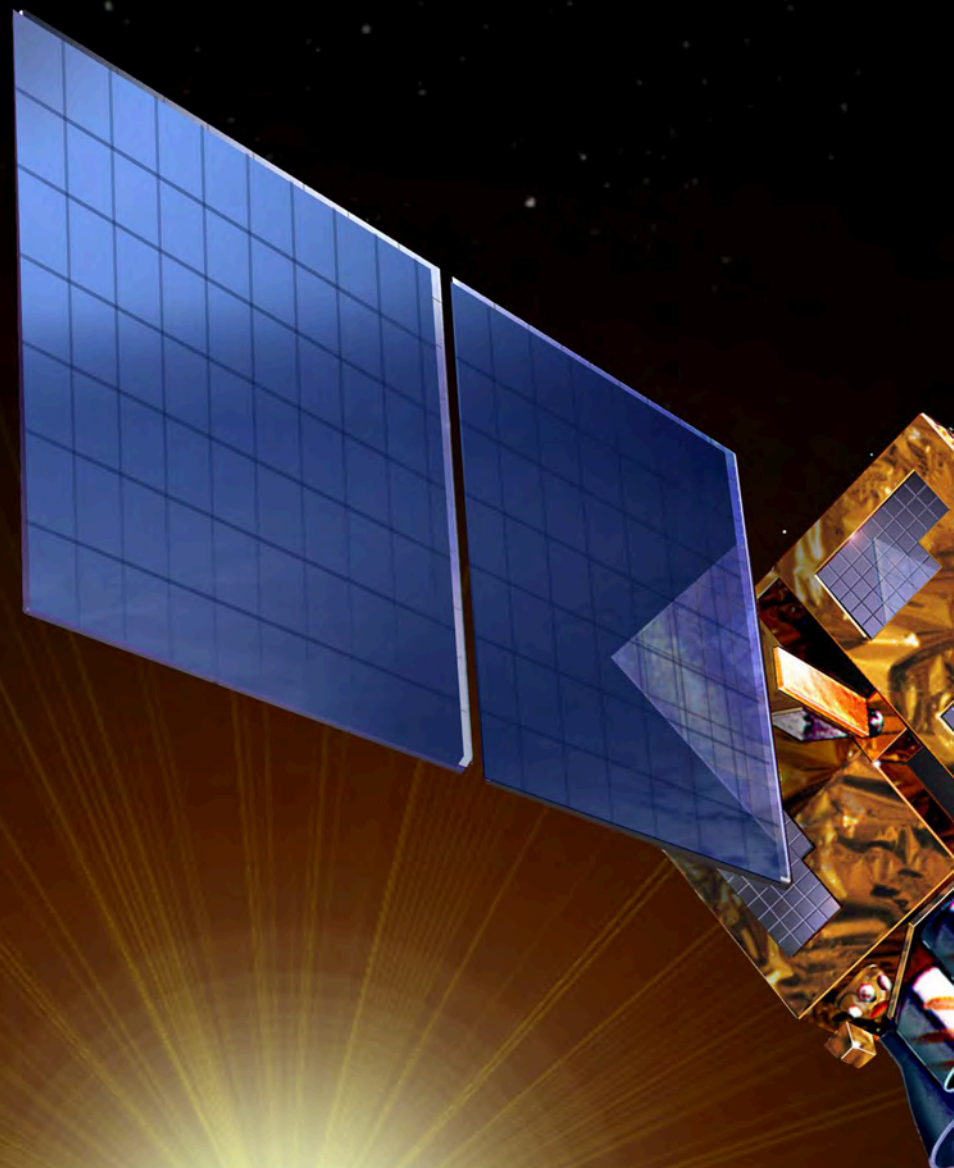

EDITORS

Michael Meindl
Rolf Dach
Yoomin Jean

Astronomical Institute
University of Bern

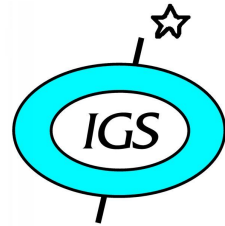

International GNSS Service

Technical Report 2011

IGS Central Bureau

<http://igs.org>

Editors: M. Meindl, R. Dach, Y. Jean
Astronomical Institute, University of Bern

Published in July 2012

IGS Central Bureau
Jet Propulsion Laboratory, M/S 238-540
4800 Oak Grove Drive
Pasadena, CA 91109-8099 USA

Tel: +1 - 818 - 354 - 2077
Fax: +1 - 818 - 393 - 6686
E-mail: cb@igs.org

<http://igs.org>

National Aeronautics and Space Administration



Jet Propulsion Laboratory
California Institute of Technology
Pasadena, California



International GNSS Service



International Association of Geodesy
International Union of Geodesy and Geophysics



Edited by Michael Meindl, Rolf Dach, Yoomin Jean
Astronomical Institute, University of Bern, Switzerland,
Compiled in June/July, 2012, extended in August, 2012.

Abstract

Applications of the Global Navigation Satellite Systems (GNSS) to Earth Sciences are numerous. The International GNSS Service (IGS), a federation of government agencies, universities and research institutions, plays an increasingly critical role in support of GNSS-related research and engineering activities. This Technical Report 2011 includes contributions from the IGS Governing Board, the Central Bureau, Analysis Centers, Data Centers, station and network operators, and others highlighting status and important activities, changes and results that took place and were achieved during 2011.

This report is available online as PDF version at
https://files.igs.org/pub/resource/technical_reports/2011_techreport.pdf.

The IGS wants to thank all contributing institutions operating network stations, data centers or analysis centers or supporting the IGS in any other form. All contributions are welcome. They guarantee the success of the IGS also in future.

Contents

I	Executive Reports	1
	The Development of the IGS in 2011 — The Governing Board's Perspective	3
	<i>U. Hugentobler</i>	
	Central Bureau	11
	<i>S. Fisher, R. Neilan, R. Khachikyan, G. Walia and D. Maggert</i>	
II	Analysis Centers	19
	Analysis Center Coordinator	21
	Center for Orbit Determination In Europe	29
	<i>R. Dach, S. Schaer, S. Lutz, M. Meindl, H. Bock, E. Orliac, L. Prange, D. Thaller, L. Mervart, A. Jäggi, G. Beutler, E. Brockmann, D. Ineichen, A. Wiget, G. Weber, H. Habrich, J. Ihde, P. Steigenberger, U. Hugentobler</i>	
	Natural Resources Canada	41
	<i>B. Donahue, R. Ferland, R. Ghoddousi-Fard, F. Lahaye, Y. Mireault</i>	
	European Space Operations Centre	51
	<i>T. A. Springer, W. Enderle, L. Agrotis, F. Dilssner, C. Flohrer, F. Pereira, N. Romero, R. Zandbergen</i>	
	GeoForschungsZentrum	61
	<i>G. Gendt, M. Ge, T. Nischan, M. Uhlemann, G. Beeskow, A. Brandt</i>	
	Geodetic Observatory Pecny	67
	<i>J. Dousa</i>	
	Centre National d'Etudes Spatiales/Collecte Localisation Satellites	75
	<i>S. Loyer, F. Perosanz, H. Capdeville, M. Pau, F. Mercier, J.-C. Marty, L. Soudarin</i>	

Jet Propulsion Laboratory	85
<i>S. Desai, W. Bertiger, B. Haines, D. Kuang, C. Selle, A. Sibois, A. Sibthorpe, and J. Weiss</i>	
Massachusetts Institute of Technology	91
<i>T. A. Herring and R. W. King</i>	
National Geodetic Survey	
<i>No report submitted</i>	
Scripps Institution of Oceanography	
<i>No report submitted</i>	
United States Naval Observatory	99
<i>C. Hackman, S. Byram, V. Slabinski, and J. Tracey</i>	
SIRGAS	107
<i>L. Sánchez</i>	
III Data Centers	117
Infrastructure Committee	119
<i>I. Romero</i>	
Crustal Dynamics Data Information System	123
<i>C. Noll</i>	
Scripps Institution of Oceanography	
<i>No report submitted</i>	
Institut National de l'Information Géographique et Forestière	
<i>No report submitted</i>	
Korean Astronomy and Space Science Institute	
<i>No report submitted</i>	
IV Working Groups, Pilot Projects	131
Antenna Working Group	133
<i>R. Schmid</i>	
Bias and Calibration Working Group	139
<i>S. Schaer</i>	

Data Center Working Group	155
<i>C. Noll</i>	
Global Navigation Satellite Systems Working Group	159
<i>R. Weber</i>	
Ionosphere Working Group	165
<i>A. Krankowski</i>	
Space Vehicle Orbit Dynamics Working Group	169
<i>M. Ziebart</i>	
Reference Frame Working Group	175
<i>P. Rebischung, B. Garayt, X. Collilieux, Z. Altamimi</i>	
Real-Time Pilot Project	183
<i>M. Caissy and L. Agrotis</i>	
RINEX Working Group	191
<i>K. MacLeod and L. Agrotis</i>	
Tide Gauge Benchmark Monitoring Project	195
<i>T. Schöne, R. Bingley, Z. Deng, J. Griffiths, H. Habrich, M. Jia, M. King, M. Merrifield, G. Mitchum, R. Neilan, C. Noll, L. Sánchez, N. Teferle, D. Thaller, P. Tregoning, P. Woodworth, G. Wöppelmann</i>	
Troposphere Working Group	211
<i>C. Hackman and S. Byram</i>	
Clock Products Working Group	219
<i>K. Senior</i>	

Part I

Executive Reports

The Development of the IGS in 2011

The Governing Board's Perspective

U. Hugentobler

Technische Universität München
Institut für Astronomische und Physikalische Geodäsie
Arcisstr. 21; 80333 Munich; Germany
e-mail: urs.hugentobler@bv.tum.de

1 Introduction

Although no technical report was published for the past few years, the IGS is continuing its success in many areas — in no small measure due to the collaborative efforts of more than 200 organizations and institutions worldwide. The IGS continues — inline with its mission — to serve as the premier source for high-quality GNSS data, products and services in support of a wide area of applications that benefit society. The quality of data, products and services are continuously improved by extending and upgrading the tracking network, implementing improved models and analysis strategies, performing consistent data reanalysis, increasing redundancy in the production chain, amongst other things. The IGS is taking up the challenges of the future — it is finalizing a global real time product, takes leadership for the maintenance and development of RINEX, and prepares for the changing GNSS landscape characterized by new constellations and signals through its Multi-GNSS Experiment.

2 IGS Activities reflect Strategic Goals

The work of the components of the IGS is guided by the strategic goals that are defined in the Strategic Plan 2008–2012.

Deliver world-standard quality GNSS data and products to all users globally with leading-edge expertise and resources.

IGS site guidelines were revised and are under review. Site tie problems related to uncalibrated radomes are being addressed by the Infrastructure Committee with dedicated experiments. The quality of the IGS products is continuously increasing by implementing the most up-to-date models and analysis strategies. For example, all IGS tracking data were reprocessed with the latest models, and a second reprocessing campaign is in preparation. The IGS is preparing for the launch of a Real-Time Service to serve real time applications. IGS installed a joined RTCM/RINEX Working Group and assumes leadership for maintenance and development of the RINEX format. The TIGA Pilot Project transitioned into a Service that is providing products on a regular basis.

Develop, integrate, and participate with new and changing GNSS systems and understand user needs to continuously improve IGS services and to provide value to a broad range of users.

The IGS issued a Call for Participation for the Multi-GNSS Experiment in order to investigate the new tracking data types and equipment, with a view to eventually upgrade the IGS network to a multi-GNSS network. A link with JAXA's Multi-GNSS Monitoring Network was established. Furthermore the IGS is involved in the International Committee on GNSS (ICG) and contributes significantly to the Global Geodetic Observing System (GGOS).

Continuously improve the effectiveness of IGS management and governance to support future growth.

The IGS continues to engage with professional organizations such as, e.g., the International Federation of Surveyors (FIG), and with experts from the geosciences and physical sciences, in particular through its Working Groups. The IGS web site is being upgraded, and web interfaces increase efficiency in collecting and handling external input.

3 Events and Highlights in 2011

A major challenge is the transition of the IGS to a truly Multi-GNSS Service. The GNSS landscape is rapidly changing. More and more new GNSS systems and signals are becoming available. To consistently integrate these new systems and signals, to familiarize with new data formats, and to develop and extend existing analysis software, a Call for Participation for a *Multi-GNSS Global Experiment* (M-GEX) was issued in August 2011 (IGS Mail 6459, <ftp://igs.org/pub/resource/pubs/IGS M-GEX VF.pdf>), soliciting the installation of multi-GNSS observing sites, operating data centers, and performing experimental analysis. The experiment is linked to the JAXA CfP for hosting sites for a Multi-GNSS Monitoring Network. It is initially planned to run from February 2012 to August 2012. First results will be presented at the IGS Workshop in July 2012. The

experiment is managed by the IGS GNSS WG chaired by Robert Weber. Eventually the experimental sites could form the core of a multi-GNSS IGS network.

Real-time GNSS has been a goal of IGS strategy for more than 10 years, in the context of providing innovative support for scientific applications and performance monitoring of GNSS. The IGS Real-Time Working Group was established in 2001, and in 2007 a CfP in the IGS Real-Time Pilot Project (RT-PP) was announced. By the end of 2011, 188 stations were participating in the RT-PP. In order to develop and maintain standards for GNSS data and develop formats for real-time GNSS, the IGS in 2008 joined the Radio Technical Commission for Maritime Services Special Committee 104 (RTCM-SC104). At its December 2010 meeting the IGS Governing Board acknowledged the efforts of the RT-PP participants and approved the transition of the Pilot Project into a Service. Preparations for launching the *IGS Real-Time Service* in 2012 commenced in 2011, with a focus on product quality and service reliability. The rationale for an open real time service is to support public benefit applications such as geophysical hazard detection and warning systems, conventional weather and space weather forecasting, and GNSS performance monitoring.

In December 2011, following a decision at the April IGS Governing Board Meeting, a joint IGS/RTCM-SC104 *RINEX Working Group* chaired by IGS was established in order to assume leadership in the maintenance and further development of the RINEX data format. Main tasks of the WG chaired by Ken MacLeod are: to establish RINEX 3 as a standard for new signals and GNSS systems, to develop and implement a transition plan to the new format, and to encourage and support the development of open software tools for data handling and quality control.

At the December 2010 meeting the IGS Governing Board approved the transition of the *GPS Tide Gauge Benchmark Monitoring Pilot Project* (TIGA-PP) into a Working Group computing precise geocentric station coordinates and velocities for GNSS stations at tide gauges on a regular basis. In February 2011 a CfP was issued (IGS Mail 6341, http://www.igs.org/projects/tiga/TIGA_CfP_2011.pdf). A total of eight proposals were received, and approved by the Governing Board following its April 2011 meeting. The chair of the TIGA WG is Tilo Schöne.

As *Troposphere WG* chair, Yoaz Bar-Sever was responsible for the generation of a high quality precise point positioning (PPP) based IGS troposphere product for many years. After extensive testing, the responsibility for the production of this product transitioned from JPL to USNO (IGS Mail 6443) in July 2011. The new chair of the Troposphere WG is Christine Hackman.

In July 2011 the IGS Governing Board received a proposal from U.S. National Geodetic Survey (NGS) for a continuation of the *Analysis Center Coordinator* (ACC) function — one of the most important functions in the IGS — for another term. The willingness of NGS to contribute three FTE staff for four years was greatly appreciated and the proposal enthusiastically accepted by the GB, also acknowledging the unwavering efforts

of Jim Ray and Jake Griffiths in the service of the IGS. The IGS's gratitude for this significant commitment was conveyed to NGS management during a visit by Ruth Neilan, Gerhard Beutler and Urs Hugentobler to NGS headquarters in Silver Springs, Washington D.C., in November 2011.

The IGS is well represented on the GGOS Coordinating Board. The IGS also plays a leadership role in the International Committee on GNSS (ICG), in particular by co-chairing Working Group D on Reference Frames, Timing and Applications and participating in the planning for the International GNSS Monitoring and Assessment System (iGMAS). The IGS is also well-represented in the International Earth Rotation & Reference Systems Service (IERS) and in IAG Sub-Commission 1.2 on reference frames, in the RTCM SC104, and others. GB members made presentations at conferences such as the FIG Working Week in Marrakech (May 2011), AfricaGEO in Capetown (May 2011), Southeast Asian Surveyors Congress in Kuala Lumpur (June 2011), GNSS-R Workshop in Shanghai (August 2011), ICG-6 Meeting in Tokyo (September 2011) among others, highlighting the mission and goals of the IGS and its range of products to a broader audience. The IGS was also given visibility as session organizers of, or presenters in, IGS-related sessions at conferences such as those of the EGU, IUGG, AGU. Tables 1 and 2 list the important events for 2011 and — for reference — for 2010.

4 Changes in the IGS Governing Board 2011

Significant changes took place in the Governing Board over the last year or so. After the elections at the end of 2010, Carine Bruyninx (Royal Observatory of Belgium), joined the GB at the beginning of 2011 as Network Representative. Henno Boomkamp (chair of the dissolved LEO WG) left the Board at the end of 2010. At the GB meeting in December 2010 als Urs Hugentobler was elected as the new Chair of the GB for the term 2011–2014. Chuck Meertens (UNAVCO) joined the Board as an Appointed Member in February 2011. With the transition of the generation of the IGS Troposphere product from JPL to USNO in July 2011, Yoaz Bar-Sever left the Board after chairing the Troposphere WG since 2003, and Christine Hackman (USNO) joined the Board as the new chair of the WG. During the IUGG General Assembly in Melbourne, the IAG appointed Zuheir Altamimi as the IAG Representative on the IGS GB. Geoff Blewitt, the former IAG Representative and a member of the IGS GB for a total of 14 years, left the Board while Zuheir, already a regular guest, joined the Board as a voting member. Chris Rizos has been an Appointed Member since 2004, however he is now a member of the GB in his capacity as IAG President. In September 2011 Yamin Dang, from the Chinese Academy of Surveying and Mapping, was appointed to the Governing Board.

In the GB elections at the end of 2011 — conducted by Richard Wonnacott together with Carine Bruyninx and Carey Noll — Shailen Desai (JPL) was elected and Tim Springer (ESA/ESOC) was re-elected as Analysis Center Representatives for 2012–2015. Shailen

Table 1: IGS events in 2011

- February 2** TIGA Call for Participation issued
- February 2** Chuck Meertens, director of the UNAVCO facility, appointed to the Governing Board
- April 3** 38th GB Meeting in Vienna (EGU)
- June 30** GB Business Meeting in Melbourne (IUGG)
- June** Transition of production of IGS Troposphere product from JPL to USNO, Christine Hackman is new Chair of the Troposphere WG and member of the IGS GB
- July 5** NGS proposal received
- August 31** M-GEX Call for Participation issued
- September 10** Yamin Dang, director of the Institute of Geodesy and Geodynamics at Chinese Academy of Surveying and Mapping, appointed to the Governing Board
- December 4** 39th GB Meeting in San Francisco (AGU)
- Election of Shailen Desai, JPL, and re-election of Tim Springer, ESA/ESOC, as Analysis Center Representatives
 - Installation of the joint IGS/RTCM RINEX Working Group, chaired by Ken MacLeod

Table 2: IGS events in 2010

- June/July** IGS Workshop in Newcastle 28.6.–01.7.2010
- June** 36th GB Meeting associated with Workshop in Newcastle
- New WG on Space Vehicle Orbit Dynamics, chaired by Marek Ziebart
 - WG on Low Earth Orbiters dissolved
- December** 37th GB Meeting in San Francisco
- Election of Urs Hugentobler as new Chair of the IGS GB
 - Election of Carine Bruyninx as IGS Network Representative
- December** IGS Terms of Reference revised in order to better represent the current IGS organization and Strategic Plan. Approved at the 37 GB Meeting (http://www.igs.org/organization/IGS_ToR_2010_final.pdf)

replaces Bob King, chair of the Scientific Organizing Committee of the IGS Workshop in Newcastle 2010, who left the Board at the end of 2011. Ken MacLeod joined the Board as chair of the newly formed IGS RINEX WG. Jim Ray left the Board after doing an excellent job as ACC from 2008–2011. Jim Ray was succeeded by Jake Griffiths.

John Dow stepped down as the chair of the GB (2003–2010) after serving the IGS GB since its start on January 1, 1994. John must take the major credit for the current healthy state of the IGS. Last but not least, Gerhard Beutler left the Board after shaping the IGS from its very beginning. He has contributed in many ways to the success of our Service. The IGS would not be where it is without the wisdom and insight — and the hard work — of Gerhard over these many years.

The Governing Board welcomed its new members and thanked the departing members for their contributions to the steering body of the IGS. The IGS is fortunate to have highly qualified and engaged individuals who contribute to our Service. The departing GB members were honoured at the GGOS reception after the IGS Governing Board meeting in San Francisco in December 2011.

5 Outlook

The year 2012 again promises a number of highlights. Most important is the IGS Workshop organized at the University of Warmia and Mazury in Olsztyn, Poland, from July 23–27, 2012. The Scientific Organizing Committee is chaired by Shailen Desai with support from Bob King, Matt King and Andrzej Krankowski, who is also the chair of the Local Organizing Committee. A major focus of the Workshop is the IGS Multi-GNSS Experiment. First results will be presented and future directions defined.

In the second half of 2012 Initial Operational Capability for the new IGS Real-Time Service will be declared. The new open service will support applications that detect, for example, in real time, motions that are precursors to natural hazards such as landslides, volcanic activity and tsunamis. Other applications may include GNSS integrity monitoring, weather forecasting, space weather monitoring and low Earth satellite orbit determination. Finally, preparations for a second reanalysis campaign are underway.

Twenty years after the installation of the IGS Pilot Service on June 21, 1992, the IGS continues to be at the forefront of high precision GNSS applications in a challenging, rapidly changing environment. This is only possible with the strong involvement of individuals, and the commitments of many institutions and organizations worldwide. The IGS GB wishes to thank all IGS Associates for their invaluable efforts in supporting the goals of the IGS. Special thanks go to the numerous site operators who take care that the IGS network — our foundation component — continues to provide the highest quality GNSS tracking data to all users.

Table 3: IGS Governing Board Members 2011 (*: voting members, EC: Executive Committee)

Member	Institution	Country	Function
* Urs Hugentobler (EC)	Technische Universität München	Germany	Board Chair, Analysis Center Representative
* Zuheir Altamimi since July 2011	Institut National de l'Information Géographique et Forestière	France	IAG Representative
Felicitas Arias	Bureau International des Poids et Mesures	France	BIPM/CCTF Representative
Yoaz Bar-Sever until July 2011	Jet Propulsion Laboratory	USA	Troposphere WG Chair
* Gerhard Beutler until July 2011	Astronomical Institute University of Bern	Switzerland	Appointed by IAG President
* Geoff Blewitt until July 2011	University of Nevada	USA	IAG Representative
* Claude Boucher	Institut National de l'Information Géographique et Forestière	France	IERS Representative
* Carine Bruyninx since start of 2011	Royal Observatory of Belgium	Belgium	Network Representative
Mark Caissy	Natural Resources Canada	Canada	Real-Time WG Chair
* Yamin Dang since Sept 2011	Chinese Academy of Surveying and Mapping	China	Appointed
John Dow (EC) until end of 2011	ESA/European Space Operations Centre	Germany	Immediate Past GB Chair
* Bruno Garayt	Institut National de l'Information Géographique et Forestière	France	Reference Frame Coordinator, IGS Representative to IAG Sub-commission 1.2
Christine Hackman since July 2011	United States Naval Observatory	USA	Troposphere WG Chair
* Gary Johnston	Geoscience Australia	Australia	Network Representative
* Bob King until end of 2011	Massachusetts Institute of Technology	USA	Analysis Center Representative
Andrzej Krankowski	University of Warmia and Mazury in Olsztyn	Poland	Ionosphere WG Chair
Ken MacLeod since Dec. 2011	Natural Resources Canada	Canada	IGS/RTCM RINEX WG Chair
* Chuck Meertens since Feb. 2011	UNAVCO	USA	Appointed
* Ruth Neilan (EC)	IGS Central Bureau, Jet Propulsion Laboratory	USA	Director of IGS Central Bureau, Secretary

Hugentobler: Governing Board

Member	Institution	Country	Function
* Carey Noll	Goddard Space Flight Center	USA	Data Center Representative, Data Center WG Chair
* James Park	Korean Astronomy and Space Science Institute	South Korea	Appointed
* Jim Ray until end of 2011	NOAA National Geodetic Survey	USA	Analysis Center Coordinator
* Chris Rizos (EC)	University of New South Wales	Australia	President of IAG since July 2011 before: appointed
Ignacio Romero	ESA/European Space Operations Centre	Germany	Infrastructure Committee Chair
Stefan Schaer	Federal Office of Topography	Switzerland	Bias and Calibration WG Chair
Ralf Schmid	Technische Universität München	Germany	Antenna WG Chair
Tilo Schöne	Deutsches GeoForschungsZentrum Potsdam	Germany	TIGA WG Chair
* Ken Senior	Naval Research Laboratory	USA	Clock Product Coordinator
* Tim Springer (EC)	ESA/European Space Operations Centre	Germany	Analysis Center Representative, IGS Representative to IERS, Chair of Associate Members Committee
Robert Weber	Vienna University of Technology	Austria	GNSS WG Chair
* Richard Wonnacott	Chief Directorate: National Geospatial Information	South Africa	Appointed
Marek Ziebart	University College London	UK	Space Vehicle Orbit Dynamics WG Chair

IGS Technical Report 2011

Central Bureau

S. Fisher, R. Neilan, R. Khachikyan, G. Walia and D. Maggert

IGS Central Bureau
Jet Propulsion Laboratory, M/S 238-540
4800 Oak Grove Drive; Pasadena, CA 91109-8099 USA
E-mail: cb@igs.org

1 Introduction

The Central Bureau supports IGS management proactively focusing on two principal functions:

1. executive management of the service, including international coordination and outreach, and
2. coordination of IGS infrastructure, including the IGS tracking network and related information management systems.

The Central Bureau is hosted at the California Institute of Technology/Jet Propulsion Laboratory and is funded by NASA.

2 Central Bureau Staff

Internal staff consists of 1.75 full time equivalent (FTE) positions, including the Director, the Operations Manager, plus Information Technology and Administrative staff. Technical support services are provided by Raytheon, Inc. and UNAVCO, Inc., which provide an additional 1.0 FTE in aggregate. In 2011, we have realigned NASA resources at UNAVCO to more effectively support IGS network monitoring and management. This has resulted in a better leveraging between NASA/IGS and U.S. National Science Foundation (NSF) activities, especially regarding backend systems for network monitoring and data/product access. As part of this realignment, UNAVCO has been providing significant help in maintaining the Central Bureau Information System (CBIS) and interfacing with users, as well as providing an independent backup outside of the CB for handling routine CBIS operations such as keeping station logs and equipment files updated.

3 IGS Executive Management

The Central Bureau has continued providing highly effective leadership of the IGS under the direction of the Governing Board, maintaining IGS as the gold standard for high-precision GNSS data and information. This CB role involves administering and supporting Governing Board activities; providing business strategy and leadership to all of the IGS components; developing strategy and formulating policy; planning and managing IGS functions such as workshops, Governing Board Meetings and outreach events in cooperation with external organizations; participation on IGS Working Groups and Committees; managing relations with stakeholders at all levels, including the GB, components, participants and users; developing IGS membership and the Governing Board; overseeing community and public relations; and handling the day-to-day operation of the IGS involving more than 200 organizations and thousands of users.

4 International Coordination and Outreach

The CB coordinates extensively with many external organizations to promote the IGS and develop key partnerships with participants and users. This has continued as a hallmark activity in 2011 that has demanded significant effort on the part of the Central Bureau, as well as the Governing Board. Driving this is an expanding participant and user base as the service continues to mature. 2011 is highlighted by the following coordination and outreach activities:

International Association of Geodesy/Global Geodetic Observing System

(IAG/GGOS): Central Bureau Director is a Coordinating Board Member. The Operations Manager participates on the GGOS Bureau for Networks and Communications.

United Nations/International Committee on GNSS (ICG):

Working Group D on reference frames and timing applications is chaired by the IGS CB Director who is also participating in planning of the International GNSS Monitoring and Assessment System (iGMAS). The 6th ICG Meeting in Tokyo was attended by the CB Director.

International Earth Rotation & Reference Systems Service (IERS):

The Operations Manager participates on the IERS Directing Board.

Radio Technical Commission for Maritime Services, Subcommittee on Differential

GNSS (RTCM/SC104): The Operations Manager coordinates the IGS RTCM membership and participates as a voting member. The CB Director is also a voting member.

International Federation of Surveyors (FIG):

The CB Director participated in FIG Working Week in Marrakech, Morocco (May 2011) to reach out to this significant user community, and also potential large station contributor.

Additionally, the AfricaGEO in Capetown, the International Council of Science/World Data System Meeting in Paris, the European Geophysical Union Meeting in Vienna, the International Union of Geodesy and Geophysics Meeting in Melbourne, the Institute of Navigation in Portland and the American Geophysical Union Meeting in San Francisco were attended by CB staff.

5 IGS Infrastructure Management

The Central Bureau's role in infrastructure management involves coordination of the IGS network, management of the Central Bureau Information System (CBIS) and coordination with other IGS infrastructure components, including the Data Centers, Analysis Centers and all Working Groups. In 2011, CB staff members have participated in activities of principal IGS committees and working Groups, including the Executive Committee, the Infrastructure Committee, the Antenna Working Group, the Reference Frame Working Group and the Real Time Pilot Project. The CB has been responsible for providing first level support to all IGS users, typically handling between 60–100 inquiries per month. A growing aspect of the CB is the IGS Institute, which is a non-profit corporation that provides business infrastructure and support to the IGS. The IGS Institute has supported the IGS website hosting and development, provided meeting conference services, provided teleconferencing services, and has supported travel for IGS participation in key events.

6 Network Status

At the end of 2011, there were 436 GNSS tracking stations within the IGS network (Figure 1). Approximately 70% of these provide data on a weekly or more frequent basis and are included in IGS weekly combination solution. Many IGS Network stations have multiple capabilities to support a range of applications. 141 stations deliver GLONASS data in addition to GPS to support the generation of the IGS GLONASS orbit product. 134 stations are co-located with external high-precision frequency standards and are used in production of the IGS clock products. A subset of the network provides meteorological data used in the generation of the IGS troposphere product. 188 stations provide data in real-time to support emerging low latency applications. There are additional stations, not considered IGS network stations, being used experimentally by IGS Clock, Real-Time and Tide Gauge projects. In all, almost 700 stations are used by IGS Analysis Centers.

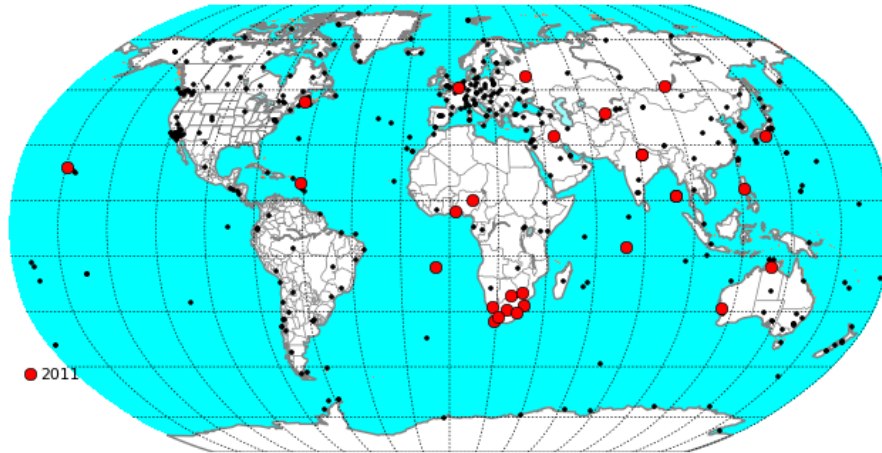

Figure 1: IGS Global Tracking Network as of December 2011. New Stations introduced during 2011 are depicted in red.

A complete listing of IGS network stations and related information can be found online at: <http://igs.org/network/netindex.html>.

A number of IGS stations are co-located with other geodetic techniques to promote combination and inter-comparisons of products and systems. The number of these has remained unchanged since 2010; 25 stations are collocated with VLBI, 37 with SLR, and 55 with DORIS. Accuracy of the tie surveys between the different observing systems remains a limiting factor in the ITRF realization. This is being addressed within the International Association of Geodesy, Global Geodetic Observing System (IAG/GGOS) Bureau for Network and Communications (BNC), where the Central Bureau participates, and by a number of agencies which participate in IGS.

There are 63 stations categorized as dormant, meaning we have not received data for 60 days or more. Eighteen of these are NGA stations (9 sites \times 2 receivers) and 27 are longer-term outages that we may consider reassigning to the "former" category. Delays in data deliveries are expected for various reasons at all of the remaining 18 sites in this category.

The NGA stations were upgraded with un-calibrated ITT equipment in 2010 and have since been offline. We have received the complete configuration history since they were upgraded, which is currently being logged and verified. We are awaiting the final absolute calibration of the ITT antenna by NGS, though we plan to make data available to be used experimentally as soon as we have verified site metadata and RINEX files. Full reinstatement of ten (9 plus one additional) stations is dependent on receiving the antenna calibration data. Backfilling of the backlogged data will occur over a slightly longer term.

Concerns about deterioration of the IGS network have arisen because a significant number of the 232 IGS08 stations are being excluded from the weekly ITRF solutions. This is

what we can explain about the exclusions in week 1637:

- 232 IGS08 Stations
- 141 Stations in weekly ITR solution
- 91 Exclusions:
 - 10 Former sites (all were declared former prior to IGS08 release)
 - 2 Replaced with nearby station (prior to IGS08 release)
 - 9 Nearby earthquake
 - 7 Upgraded with uncalibrated antenna/radome
 - 16 High residual on equipment change
 - 32 Short-term data outage (most common) or unexplained
 - 15 Degraded fit with IGS08 for unknown reason

Stations excluded because degraded fit with IGS08 or high residual on an equipment change must be looked into further with help from the Analysis Centers.

7 Site Guidelines

The CB has helped the IC in revising on the IGS Site Guidelines to reflect currently recommended best practices. The new Guidelines include procedures for upgrading station equipment, prescribing periods of operation where old and new equipment are operated simultaneously to assure that discontinuities are properly mapped. In addition, stricter antenna requirements have been introduced as recommended during the 2008 IGS Workshop, and guidelines for real-time stations were added. The IGS Governing Board has provisionally accepted the new guidelines and plans to formally adopt them by mid-2012 after comments by the broad IGS community are integrated. Once completed, the new guidelines will be posted on the IGS website.

8 Real-time Project

The CB has participated in the real-time working group, helping to coordinate some activities, especially the participation in RTCM, where standards for data and correction formats are being addressed to assure that the RTCM remains fully compatible with RINEX v3.01. In support of real-time efforts, an Ntrip caster has been implemented on the CBIS — see <http://igs.org:2101/home>. We currently have 189 stations participating in the Real Time Pilot Project. The strategy for developing an IGS real time product is discussed further in the RT Working Group report below.

9 Multi-GNSS Project (M-GEX)

A focused Multi-GNSS experiment called M-GEX is being fully supported by the CB, including developing the project website and verifying the new site logs and data files. A call to participate in was circulated in June by the Multi-GNSS Working Group (see IGSMAIL #6459 and <ftp://igs.org/pub/resource/pubs/IGS M-GEX VF.pdf>). This was developed to establish a data set of new GNSS signals, including the Russian GLONASS, the Japanese QZSS, European Galileo, and Chinese Compass, available for experimentation. The project is to run from February to August 2012. Participating stations are anticipated to eventually form the core of a multi-GNSS IGS network and service. Details relating to the M-GEX project are discussed further below and are available online at <http://igs.org/mgex/>.

10 Radome Experiment

Along with the Infrastructure Committee, the CB is helping to coordinate the Radome experiment. Radomes at twenty IGS stations that are co located at SLR or VLBI sites have not been calibrated to IGS standards. Station operators were asked to participate in an experiment to assess the effects of these radomes by removing them for a two-month period during 2011. Six stations have been able to respond so far, though the experiment will continue into 2012 to allow more time for additional stations to participate.

See: <https://sites.google.com/a/igs.org/igsnet/infrastructure-committee/radome-experiment-2011>.

11 Central Bureau Information System (CBIS)

The Central Bureau Information System (CBIS) is the primary information portal for the IGS. It contains information about the IGS organization, network, data and products. The CB is charged with keeping all information up to date, including IGS membership, working group and Governing Board Information, the IGS equipment files, process descriptions, publications, the analysis summary files and reports and station logs. To improve capture and availability of network related information, backend systems that manage network information and QC information are being redesigned in 2011.

All site log meta data are now imported into the Site Log Manager database, which is operating in a test mode. Though not fully operational yet, this is already facilitating improvements in site meta data accuracy. Consistency of site metadata contained on station logs and RINEX headers has been continuously monitored through the year. Typically, there are just a few inconsistencies at any given time, which are normally resolved within days.

A prototype IGS network interface is operating at <http://network.igs.org/> which is intended to provide better access to station meta data and QC information. This effort is being conducted using NASA funds at UNAVCO, leveraging related activities funded by NSF.

Network performance monitoring reports, similar to the summary reports at the EUREF website that give an aggregate view of the network (threshold compliance, availability, etc.), are being worked on now and will soon be available on the web.

Effort to update site photos has so far resulted in 132 stations submitting new photos in the desired format. The new photos have been posted on the site pages on igs.org.

We have received estimates from two commercial web design firms to implement the front-end part of a new IGS website, which will require significant resources to accomplish. Funding is being sought.

Network monitoring and other information is summarized for internal IGS use online at: <https://sites.google.com/a/igs.org/igsnet/igs-net>.

12 Meetings Attended

A significant number of meetings and workshops were attended by IGS participants in 2011. A listing of these is available online at <http://igs.org/events/>.

Publications

2009–2011 IERS Annual Report.

In addition, many papers, articles and presentations relating to IGS were published or presented by IGS participants in 2011. A partial listing of these is available online at <http://tinyurl.com/IGS-bibli>.

Part II

Analysis Centers

Analysis Center Coordinator

IGS-Chair: U. Hugentobler
ACC 2011: J. Ray and J. Griffiths
ACC 2012: J. Griffiths and K. Choi
igs.acc@noaa.gov

1 ACC Activities

IGS products were combined 2011 without interruption. Product flow and quality were continuously monitored and systematically validated. Contact to the Analysis Centers was kept with intensive exchange through the IGS-ACS mail exploder and personal communications. Significant effort was spent for maintaining the ACC's web pages and with answering frequent questions of users. The ACC was present at scientific conferences (EGU April 2011 and AGU Dec. 2011) with presentations related to IGS products, their quality and issues. Important issues discussed in presentations, at AC splinter meetings and e-mail exchange were over-constrained parameters, draconitic anomalous frequencies, tidal aliasing, handling of satellite attitude for clock parameter estimation, low number of Analysis Centers providing clock solutions for the IGS Ultra Rapid solution.

In 2011 the switch to the reference frame IGS08 took place after dedicated testing campaigns and with distributing associated information to the users. Two Analysis Centers started to generate GLONASS products while one center stopped. Contacts with the GNSS Research Center at Wuhan University - proposing to install a new Analysis Center - were established. The results of the first reprocessing campaign were finalized and preparations for a second reprocessing campaign were initiated.

2 IGS Product Quality

Table 1 gives an overview of the estimated quality of the IGS core products at the end of 2011. Consistency of IGS orbit and satellite clock corrections is illustrated in figure 1, consistency of pole coordinates and length of day estimates in figures 2. Details can be found at the Analysis Center Coordinator's home page <http://acc.igs.org/>, in IGS Mail #6053 (<http://igscb.jpl.nasa.gov/mail/igsmail/2010/msg00001.html>) and in various presentations listed below. Information about performance of station clocks can be found in IGS Mail #6511 (<http://igscb.jpl.nasa.gov/pipermail/igsmail/2011/006503.html>) and references therein.

Table 1: Quality of the IGS core products at end of 2011 (see <http://acc.igs.org/erp/egu12-igu-erps.pdf>)

Series	ID	Product Type	Accuracy	Output Interval	Update	Latency
Ultra-Rapid (predicted)	IGU	GPS orbits	5 cm (1D)	15 min	every 6h	3-9 h
		GLONASS orbits	10 cm (1D)	15 min		
		GPS satellite clocks	3 ns RMS, 1.5 ns Sdev	15 min		
		EOPs	250 μ s (PM) 50 μ s (dLOD)	6h		
Ultra-Rapid (observed)	IGA	GPS orbits	3 cm (1D)	15 min	every 6h	3-9 h
		GLONASS orbits	5 cm (1D)	15 min		
		GPS satellite clocks	150 ps RMS, 50 ps Sdev	15 min		
		EOPs	<50 μ s (PM) , 10 μ s (dLOD)	6h		
Rapid	IGR	GPS orbits	2.5 cm (1D)	15 min	daily 17 UTC	17-41h
		GPS satellite & station clocks	75 ps RMS, 25 ps Sdev	5 min		
		EOPs	<40 μ s (PM) 10 μ s (dLOD)	daily		
Final	IGS	GPS orbits	2.5 cm (1D)	15 min	weekly each Thursday	11-17d
		GLONASS orbits	<5 cm (1D)	15 min		
		GPS satellite & station clocks	75 ps RMS 20 ps Sdev	30 s (SVs), 5 min (sta)		
		EOPs	<30 μ s (PM) 10 μ s (dLOD)	daily		
		Terrestrial frames	2 mm N&E, 5 mm U	weekly		

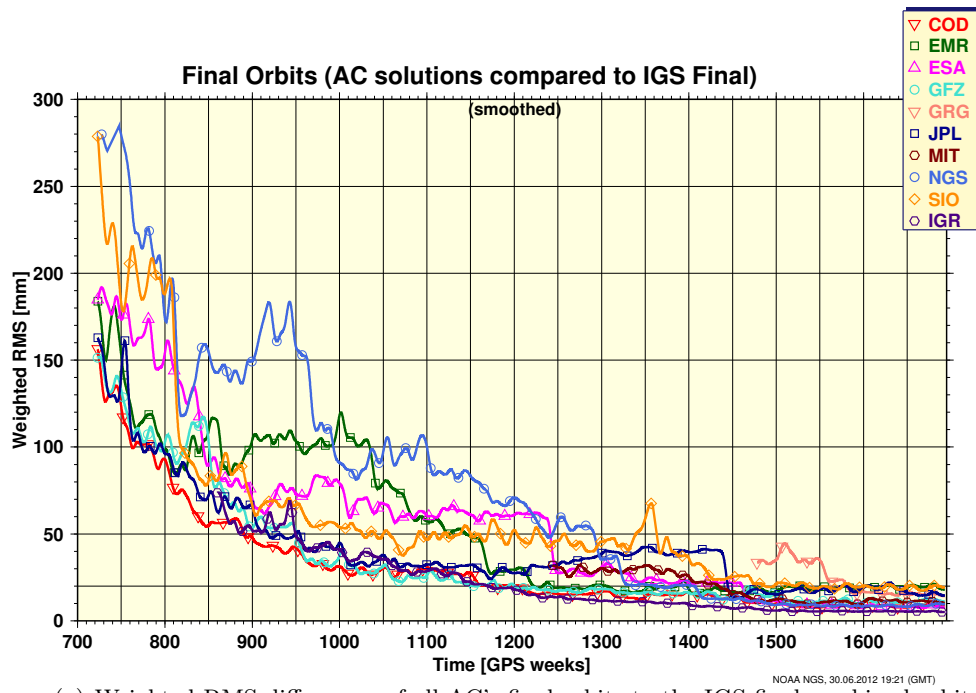

(a) Weighted RMS differences of all AC's final orbits to the IGS final combined orbit.

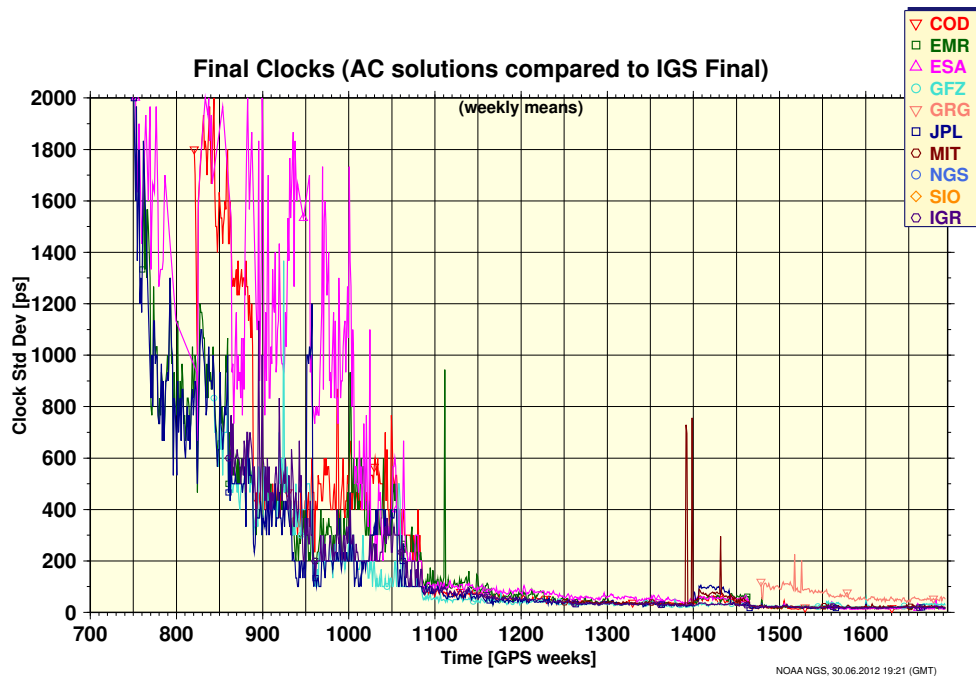

(b) Standard deviation of IGS final clock solutions.

Figure 1: Comparison of the GPS satellite related IGS final products with the AC contributions.

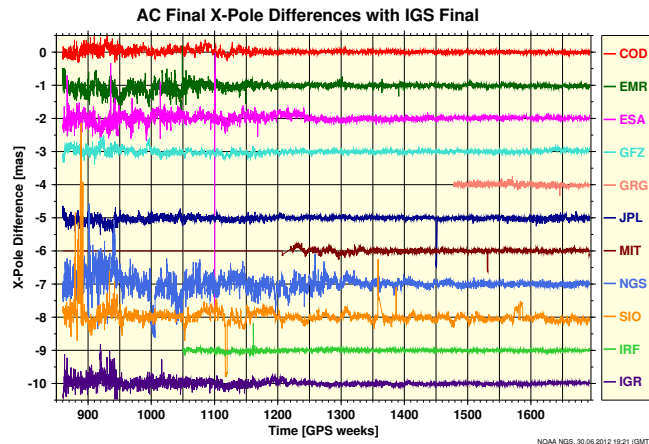

(a) X-pole differences between IGS Analysis Centers.

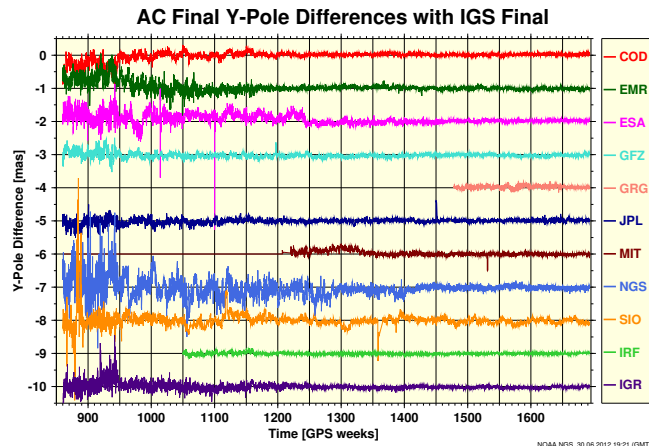

(b) Y-pole differences between IGS Analysis Centers.

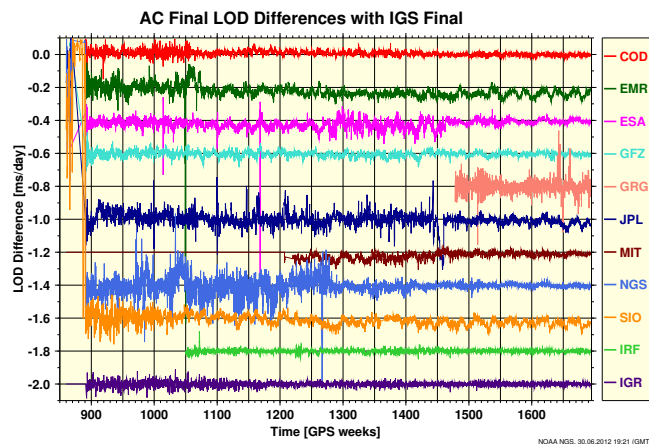

(c) Length of Day differences between IGS Analysis Centers.

Figure 2: Comparison of the IGS final products with the AC contributions for the Earth rotation parameters.

3 Events in 2011

A number of events took place in 2011. The most important of them are listed in the table below.

Jan. 2011 GRGS starts submitting Final GLONASS orbits

March 2011 Carlos Rodriguez (TUM) provides subroutines for albedo modelling

April 2011 IGS adopts new IGS08 reference frame & igs08.atx antenna calibrations in all its products starting 1632/0

April 2011 AC splinter meeting held in Vienna in association with the EGU 2011 meeting

May 2011 Results from reprocessing campaign 1 finalized

May 2011 BKG stops submitting Final GLONASS orbits

July 2011 Yaw attitude subroutine provided by Jan Kouba

Sept. 2011 EMR starts submitting Final GLONASS orbits

Nov. 2011 Letter of intent from the GNSS Research Center at Wuhan University proposing to establish a new IGS Analysis Center there.

Dec. 2011 AC splinter meeting held in San Francisco in association with the Fall 2011 AGU meeting.

4 IGS08 Reference Frame Introduced

Effective April 17, 2011 the IGS adopted the new IGS08 reference frame, which is closely related to ITRF08. The IGS08 computations were based on a selected globally distributed subset of 232 well performing ITRF08 ground stations. Coincidentally, the IGS also adopted a new ground antenna calibration model (IGS08.atx) based on absolute calibration of the antennas. Satellite phase center offsets were also re-estimated based on ITRF05 to ITRF08 scale differences. Details relating to IGS08 and the IGS08.atx antenna model are contained in IGSMail #6354 and IGSMail #6355 respectively. Effects on ground station coordinates arising from the IGS05 to IGS08 datum shift, as well as the change over to the new antenna models are discussed in IGSMail #6356 and IGSMail #6401.

5 Results from First Reprocessing Campaign Finalized

Results of the first IGS reprocessing campaign (Repro1) covering the period 1994-2007 were announced in April 2010 (see IGSMail #6136) and the product files have been finalized and distributed to the IGS Global data Centers for access by users in May 2011, see IGSMail #6445, <http://igscb.jpl.nasa.gov/pipermail/igsmail/2011/006437.html>). Related product files have now been finalized and distributed to the IGS Global Data Centers for access by users. Details relating to the Repro1 Campaign are available online at <http://acc.igs.org/reprocess.html>.

6 References

For more information please refer to the Analysis Center Coordinator's web page <http://acc.igs.org/> where a large number of references, links to journal papers and presentations related to IGS products are available. A few important references are given here:

- J. Ray and J. Griffiths (2010): Status of IGS core products (2010)
http://acc.igs.org/ACC-prods_IGS10.pdf
- Griffiths et al. (2012): IGS Preparations for the Next Reprocessing and ITRF
http://acc.igs.org/repro2/egu12_ig2_preps.pdf
- Ray (2011): Why does the IGS care about EOPs?
http://acc.igs.org/erp/igs-eop-requirements_NGA11.ppt
- Ray and Griffiths (2012): High Accuracy Subdaily ERPs from the IGS
<http://acc.igs.org/erp/egu12-igu-erps.pdf>
- Gendt et al. (2010): IGS reprocessing – Summary of orbit/clock combination & first quality assessment
http://acc.igs.org/repro1/repro1_IGSW10.pdf
- Ray and Griffiths (2011): Status of IGS orbit modeling & areas for improvement
<http://acc.igs.org/orbits/egu11-orbits.ppt>
- Choi et al (2011): Evaluation of GPS orbit prediction strategies for the IGS Ultra-rapid products
http://acc.igs.org/orbits/gps-predictions_agu11poster.pdf
- Griffiths and Ray (2011): Subdaily alias & draconitic errors in the IGS orbits
http://acc.igs.org/orbits/igs-orbit-errs_agu-f11.ppt
- Ray et al. (2011): Dependence of IGS products on the ITRF datum
http://acc.igs.org/trf/igs+itrf-datum_refag10.pdf

- Ray et al. (2011): Consistency of crustal loading signals derived from models & GPS: Inferences for GPS positioning errors
http://acc.igs.org/trf/pos-errs_agu-f11.ppt
- IGS Mail #6053: status of IGS orbit products
<http://igs.cb.jpl.nasa.gov/mail/igsmail/2010/msg00001.html>
- IGS Mail #6511: Final report on IGS station clocks
<http://igs.cb.jpl.nasa.gov/pipermail/igsmail/2011/006503.html>
- IGS Mail #6445: repro1 product files finalized
<http://igs.cb.jpl.nasa.gov/pipermail/igsmail/2011/006437.html>
- IGS Mail #5874: Status of IGS Ultra-rapid products:
<http://igs.cb.jpl.nasa.gov/mail/igsmail/2009/msg00000.html>

Center for Orbit Determination in Europe (CODE)

R. Dach¹, S. Schaer²

*S. Lutz¹, M. Meindl¹, H. Bock¹, E. Orliac¹, L. Prange¹,
D. Thaller¹, L. Mervart^a, A. Jäggi¹, G. Beutler¹*

E. Brockmann², D. Ineichen², A. Wiget²

G. Weber³, H. Habrich³, J. Ihde³

P. Steigenberger⁴, U. Hugentobler⁴

¹ Astronomical Institute, University of Bern, Bern, Switzerland
E-mail: `code@aiub.unibe.ch`

² Federal Office of Topography swisstopo, Wabern, Switzerland

³ Federal Agency of Cartography and Geodesy,
Frankfurt a. M., Germany

⁴ Institut für Astronomische und Physikalische Geodäsie,
Technische Universität München, Munich, Germany

1 The CODE consortium

CODE, the Center for Orbit Determination in Europe, is a joint venture of the following four institutions:

- Astronomical Institute, University of Bern (AIUB), Bern, Switzerland,
- Federal Office of Topography swisstopo, Wabern, Switzerland,
- Federal Agency of Cartography and Geodesy (BKG), Frankfurt a. M., Germany, and
- Institut für Astronomische und Physikalische Geodäsie, Technische Universität München (IAPG, TUM), Munich, Germany.

The operational computations are performed at the AIUB whereas reprocessing activities are usually carried out at IAPG, TUM. All solutions and products are produced with the latest development version of the Bernese GNSS Software (Dach et al., 2007).

^aInstitute of Geodesy, Czech Technical University in Prague, Czech Republic

2 CODE products available to the public

A wide variety of GNSS solutions based on a rigorous combined GPS/GLONASS data processing scheme is computed at CODE. The products are made available through anonymous ftp:

<ftp://ftp.unibe.ch/aiub/CODE/> or <http://www.aiub.unibe.ch/download/CODE/>
An overview of the files is given in Tab. 1.

Table 1: CODE products available through anonymous ftp.

CODE *ultra-rapid* products available at <ftp://ftp.unibe.ch/aiub/CODE>

COD.EPH_U	CODE ultra-rapid orbits, updated every 6 hours
COD.ERP_U	CODE ultra-rapid ERPs belonging to the ultra-rapid orbit product
COD.TRO_U	CODE ultra-rapid troposphere product, SINEX format
COD.SUM_U	Summary of stations used for the latest ultra-rapid orbit
COD.ION_U	Last update of CODE rapid ionosphere product (1 day) complemented with ionosphere predictions (2 days)
COD.EPH_5D	Last update of CODE 5-day orbit predictions, from rapid analysis, including all active GLONASS satellites

CODE *rapid* products available at <ftp://ftp.unibe.ch/aiub/CODE>

CODwwwwd.EPH_R	CODE rapid orbits
CODwwwwd.EPH_P	CODE 24-hour orbit predictions
CODwwwwd.EPH_P2	CODE 48-hour orbit predictions
CODwwwwd.EPH_5D	CODE 5-day orbit predictions
CODwwwwd.ERP_R	CODE rapid ERPs belonging to the rapid orbits
CODwwwwd.ERP_P	CODE predicted ERPs belonging to the 24-hour orbit predictions
CODwwwwd.ERP_P2	CODE predicted ERPs belonging to the 48-hour orbit predictions
CODwwwwd.ERP_5D	CODE predicted ERPs belonging to the 5-day orbit predictions
CODwwwwd.CLK_R	CODE rapid clock product, clock RINEX format
CODwwwwd.TRO_R	CODE rapid troposphere product, SINEX format
CODwwwwd.SNX_R.Z	CODE rapid solution, SINEX format
CORGddd0.yyI	CODE rapid ionosphere product, IONEX format
COPGddd0.yyI	CODE 1-day or 2-day ionosphere predictions, IONEX format
CODwwwwd.ION_R	CODE rapid ionosphere product, Bernese format
CODwwwwd.ION_P	CODE 1-day ionosphere predictions, Bernese format
CODwwwwd.ION_P2	CODE 2-day ionosphere predictions, Bernese format
CGIMddd0.yyN_R	Improved Klobuchar-style ionosphere coefficients, navigation RINEX format
CGIMddd0.yyN_P	1-day predictions of improved Klobuchar-style ionosphere coefficients
CGIMddd0.yyN_P2	2-day predictions of improved Klobuchar-style ionosphere coefficients
P1C1.DCB	CODE sliding 30-day P1-C1 DCB solution, Bernese format, containing only the GPS satellites
P1P2.DCB	CODE sliding 30-day P1-P2 DCB solution, Bernese format, containing all GPS and GLONASS satellites
P1P2_ALL.DCB	CODE sliding 30-day P1-P2 DCB solution, Bernese format, containing all GPS and GLONASS satellites and all stations used
P1P2_GPS.DCB	CODE sliding 30-day P1-P2 DCB solution, Bernese format, containing only the GPS satellites

Table 1: CODE products available through anonymous ftp (cont.).CODE *final* products available at <ftp://ftp.unibe.ch/aiub/CODE/yyyy/>

yyyy/CODwwwwd.EPH.Z	CODE final GNSS orbits, our official IGS orbit product
yyyy/CODwwww7.ERP.Z	CODE final ERPs belonging to the final orbits, values for the full week
yyyy/CODwwwwd.CLK.Z	CODE final clock product, Clock RINEX format, with a sampling of 30 sec for the satellite and the reference (station) clock and 5 min for all remaining station clock corrections
yyyy/CODwwwwd.CLK_05S.Z	CODE final clock product, Clock RINEX format, with a sampling of 5 sec for the satellite and the reference (station) clock and 5 minutes for all remaining station clock corrections
yyyy/CODwwwwd.TRO.Z	CODE final troposphere product, SINEX format
yyyy/CODGddd0.yyI.Z	CODE final ionosphere product, IONEX format
yyyy/CODwwwwd.ION.Z	CODE final ionosphere product, Bernese format
yyyy/CODwwwwd.SNX.Z	CODE daily SINEX product
yyyy/CODwwww7.SNX.Z	CODE weekly SINEX product
yyyy/CODwwww7.SUM.Z	CODE weekly summary files
yyyy/COXwwwwd.EPH.Z	CODE precise GLONASS orbits (for GPS week 0990–1066)
yyyy/COXwwww7.SUM.Z	CODE weekly summary files of GLONASS analysis (dito)
yyyy/CGIMddd0.yyN.Z	Improved Klobuchar-style ionosphere coefficients, nav. RINEX format
yyyy/P1C1yyymm.DCB.Z	CODE monthly P1-C1 DCB solutions, Bernese format, containing only the GPS satellites
yyyy/P1P2yyymm.DCB.Z	CODE monthly P1-P2 DCB solutions, Bernese format, containing all GPS and GLONASS satellites
yyyy/P1P2yyymm_ALL.DCB.Z	CODE monthly P1-P2 DCB solutions, Bernese format, containing all GPS and GLONASS satellites and all stations used

Note, that as soon as a final product is available the corresponding rapid, ultra-rapid, or predicted products is removed from the aftp server.

Some statistical information about typical daily solutions is given in Tab. 2 as of December 2011. The network of stations, considered by CODE for the final product generation, is shown in Fig. 1.

Table 2: Statistics on CODE daily solutions (compiled over December 2011).

Number of	ultra-rapid	rapid	final
stations	90	120	250
satellites	55 (31 GPS + 24 GLONASS)		
observations	300,000	750,000	1,500,000
parameters	4,800	11,000	20,000

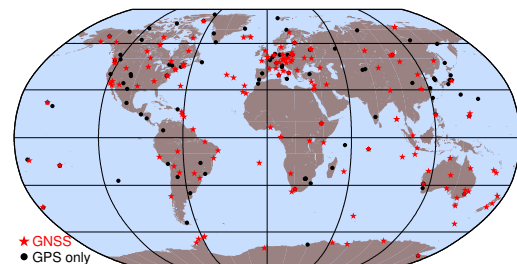
**Figure 1:** Network used for the GNSS final processing at CODE by the end of 2011.

3 Changes in the daily processing for the IGS

The CODE processing scheme for daily IGS analyses is constantly subject to updates and improvements. The last published technical report was published in 2008 (Hugentobler et al., 2008). Since that time a lot of changes in the CODE processing scheme, the data modelling, and analysis algorithms have taken place. Highlights from the interval between the last report and the end of 2010 are given in Tab. 3. In Sect. 3.1 we give an overview of important development steps in the year 2011. Two of the model improvements are further illustrated in Sect. 3.2.

Table 3: Selected modifications of the CODE processing between 2005 and 2010.

Date	DoY/Year	Description
07-May-2005	127/2005	Do not set up stochastic pulses at 12:00 for ultras up to 15 UT
13-Nov-2005	317/2005	Use CODE RPR model as a priori for all product lines
19-Mar-2006	078/2006	Ocean tide model for loading changed from GOT00.2 to FES2004
05-Nov-2006	309/2006	Change from relative to absolute antenna phase center modelling Use IGS05 for geodetic datum definition Troposphere model: GPT/GMF for vertical and TANZ for gradients Use of updated CODE RPR a priori model for all satellites Mean pole computed according to IERS2003 standards Shapiro effect applied to GNSS (not only SLR) Apply ocean tidal loading related center of mass corrections <code>hardisp.f</code> is used to interpolate ocean tidal loading model constituents
04-Dec-2006	338/2006	Phase wind-up, polarization effect for clock estimation Real-time data collection established using the <code>bnc</code> tool to complete hourly and daily RINEX files
04-Nov-2007	308/2007	Use zero-model as RPR a priori for all GLONASS satellites
27-Apr-2008	118/2008	Inclusion of all available NGA stations in the CODE final analysis Set up GNSS satellite antenna PCV parameters specific to each individual satellite (for later retrieval)
04-May-2008	125/2008	Phase-consistent high-rate (5-sec) GPS satellite clock corrections
29-Jun-2008	181/2008	Time resolution for EOP estimation increased internally (from 2 to 1 hr)
29-Jun-2008	181/2008	Do not resolve ambiguities between Block IIR-M and other satellites for LEICA and NOV receivers (L2C 0.25 cycle problem)
28-Sep-2008	272/2008	Numerous new GLONASS tracking stations (global coverage achieved)
26-Apr-2009	116/2009	New version of <code>hardisp.f</code> : more tidal constituents, phase bug corrected
26-Jul-2009	207/2009	No three day arc if the RMS of the orbit fit exceeds: 5 cm for GPS and 10 cm for GLONASS (for GLONASS no automated arc split was included so far)
08-Aug-2009	220/2009	Handle more cases regarding the quarter-cycle problem
04-Mar-2010	063/2010	Higher order ionosphere (HOI: 2nd and 3rd order with IGRF v.11) implemented; enabled in rapid procedure for test purposes
22-Jun-2010	173/2010	GNSS code bias retrieval from RINEX files GPS & GLONASS P1C1 for satellites and receivers GPS & GLONASS P2C2 for satellites and receivers
15-Sep-2010	258/2010	Verification of ambiguity resolution results activated
03-Oct-2010	276/2010	Troposphere model VMF1 for final, rapid, ultra-rapid HOI corrections also activated for the final

3.1 Overview of changes in the processing scheme in 2011

Table 4 gives an overview of the major changes implemented during year 2011. Details on the analysis strategy can be found in the IGS analysis questionnaire at the IGS Central Bureau (<ftp://igs.cb.jpl.nasa.gov/igs.cb/center/analysis/code.acn>).

Table 4: Selected modifications of the CODE processing, over 2011.

Date	DoY/Year	Description
09-Jan-2011	009/2011	Orbit repeatability unit changed from cm to mm
15-Jan-2011	015/2011	An extra set of four parameters is set up for each GLONASS observing station to characterize <ul style="list-style-type: none"> • one GLONASS-GPS receiver antenna offset vector (three components) and • one GLONASS-GPS ZPD troposphere bias.
during Feb-2011		Extension of CODE final and rapid orbit validation (step-by-step) New source of orbit quality measure table in the weekly CODE summary starting with week 1625
27-Feb-2011	058/2011	GLONASS ambiguity resolution enabled (details below)
17-Apr-2011	107/2011	Use IGS08 for geodetic datum definition and receiver/satellite antenna model (instead of IGS05)
04-Jul-2011	185/2011	ANTEX update from IGS08_1639 to IGS08_1643 (GLONASS-K1 Z-offset value change from 0.0 to 1.75 m)
06-Sep-2011	249/2011	Extract a priori coordinates/velocities with 5 digits from IGS08.SNX.
27-Oct-2011	300/2011	Complete Ocean tidal loading table updated from http://www.oso.chalmers.se/~loading/ because of detected inconsistencies between recent and older results

Of course, several other improvements not listed in Tab. 4 were implemented. Those mainly concern data download and management, sophistication of CODE's analysis strategy, software changes (improvements), and many more. As these changes are virtually not relevant for users of CODE products, they will not be detailed on any further.

3.2 Details on selected model changes

As an indicator of the influence of the model changes on the CODE orbit quality, the three consecutive one-day orbit solutions are fitted by one arc solving for the initial conditions, three constant and six once-per-revolution parameters in the Sun-oriented coordinate system at the satellite. The median from the RMS of this orbit fit from all satellites of GPS and GLONASS is plotted for each day between October 2010 and April 2012 in Fig. 2.

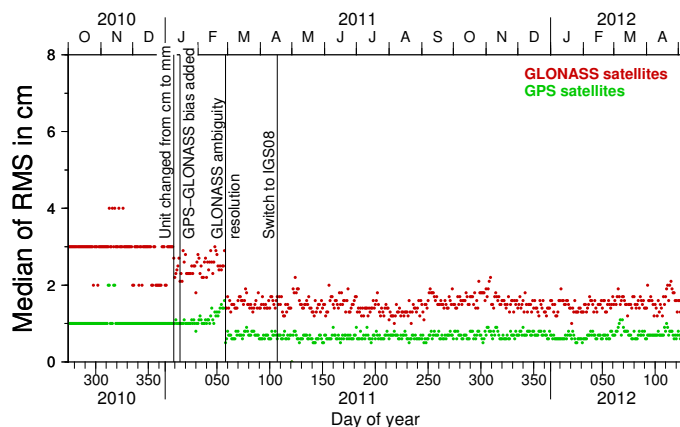

Figure 2: Median of the RMS from a three-day orbit fit.

GPS/GLONASS ambiguity resolution

In particular the benefit from the ambiguity resolution for the GLONASS is clearly visible in Fig. 2. It is remarkable that this also did improve the orbits for the GPS satellites.

The following strategies are applied depending on the lengths of the baselines:

L1/L2 (<20 km): Direct ambiguity resolution to the original observations using the *SIGMA*-strategy; for GPS and GLONASS (no restrictions regarding freq. and receiver type; GLONASS-SD bias retrieval)

WL/NL (<6000 km): Ambiguity resolution based on Melbourne-Wübbena and afterwards narrow-lane linear combinations using the *SIGMA*-strategy; only for GPS

L5/L3 (<200 km): Ambiguity resolution based on wide- and narrow-lane linear combinations using the *SIGMA*-strategy; for GPS and GLONASS (no restrictions regarding frequency and receiver type; GLONASS-SD bias retrieval and introduction)

QIF (<2000 km): Unresolved ambiguities from the two steps above are resolved with the *QIF*-strategy; for GPS and GLONASS (only the same frequency channels)

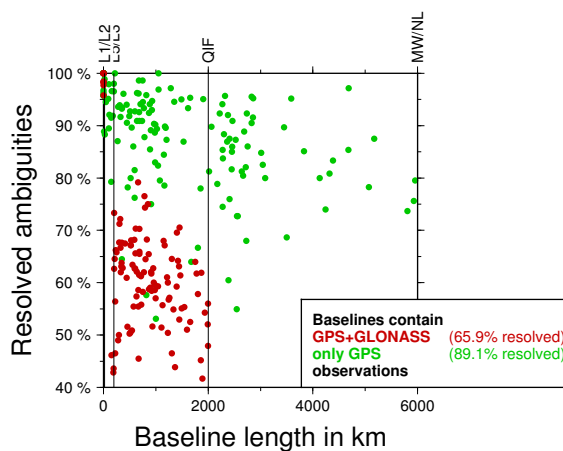

Figure 3: Ambiguity resolution with different strategies for day 350 of year 2011.

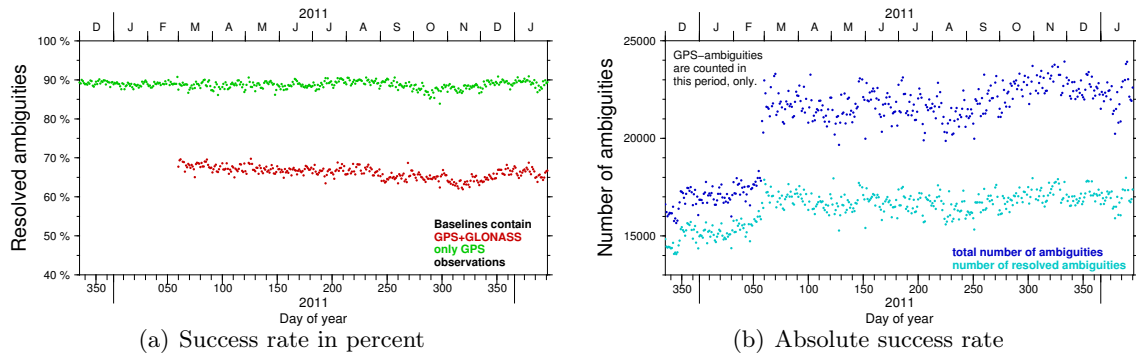

Figure 4: Success rate of the ambiguity resolution in the CODE processing.

The success rate of the ambiguity resolution for the GPS observations was not reduced by activating the resolution algorithms for GLONASS (see Fig. 4). As confirmed by Fig. 3, the limited resolution rate for the combined GPS/GLONASS baselines with respect to the GPS-only baselines can mainly be explained by the restrictions introduced by the GLONASS ambiguity resolution algorithm (see above explanation). More details on the multi-GNSS ambiguity resolution at CODE are given in Schaer and Meindl (2011).

GPS/GLONASS biases in IGS05- and IGS08-frame and -antenna solutions

The network processed by the CODE analysis center in the years 2009 and 2010 has been re-processed twice:

1. using the IGS05 antenna corrections together within the IGS05 reference frame
2. using the new IGS08 antenna corrections together within the IGS08 reference frame

In both solution series (based on IGS05 and IGS08) so called GPS/GLONASS bias parameters are included:

- for the station coordinates equivalent to independent sets of weekly coordinates for GPS and GLONASS (applying a zero mean condition on the XYZ-components inbetween them) and
- the troposphere parameters (one constant bias for each week) to absorb a potential mismodeling in the receiver antenna phase center variations.

When adding the GPS/GLONASS bias parameters the RMS of the post-fit residuals for the weekly normal equation is reduced by about 1% — this cannot only be explained by the change of the degree of freedom (400 additional parameters with respect to 350,000 other parameters and nearly 27,000,000 observations). This improvement is achieved in both series, based on IGS05 or IGS08 modeling standards.

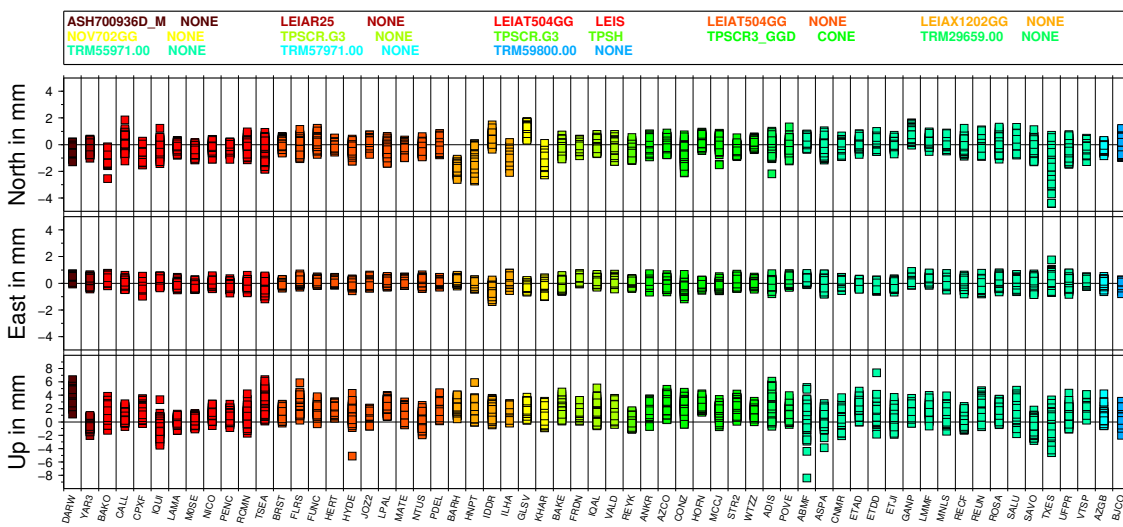

(a) IGS05-based solution

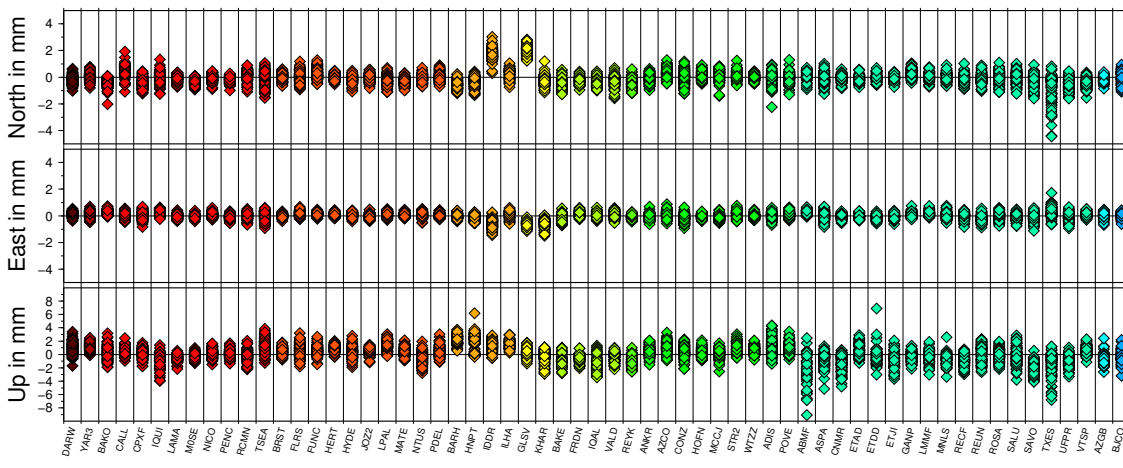

(b) IGS08-based solution

Figure 5: Differences in the computed weekly station coordinates between the default and the solution with the GPS/GLONASS bias estimation.

The coordinate differences between the standard solution without GPS/GLONASS biases and the new solution schemes with solving for one set of biases per week are plotted in Fig. 5. It is noticeable that all differences in the IGS05-based solution have a positive sign in the vertical component. This may be explained by a GLONASS-related scale inconsistency, e.g., due to the satellite antenna offsets. In the IGS08-based solution this feature is not visible. Nevertheless, there are systematic effects in the vertical component as well, e.g., most of the TRIMBLE-antennas show negative differences but in the results for stations equipped with LEICA- or TOPCON-antennas positive signs dominate.

4 Contribution to GLONASS satellite antenna calibration

CODE has reprocessed the GPS/GLONASS network starting from archived observation files from June 2003 until end of January 2011. The IGS08.atx receiver antenna phase center corrections — for more than 50% of the antenna radome combinations specific GLONASS calibration values were available — have been applied.

For all GLONASS satellites and the GPS satellite with the SVN 62 new antenna phase center corrections have been estimated following the strategy introduced by Dach et al. (2011). For the GPS satellite antennas (with exception of SVN 62) the antenna phase center corrections according to the IGS08.atx model have been introduced to guarantee the full consistency of the antenna phase center corrections for the additional satellites.

An alternative solution for GLONASS satellite antenna corrections have been provided by the analysis center at ESOC. Further information on a comparison and combination can be found in Dilssner et al. (2011). The combined antenna phase center model is a part of the IGS08.atx.

5 Reprocessing activities at CODE in 2011

The release of the IGS08 reference frame and the corresponding antenna phase center corrections for the receivers and satellites together with other updates in the CODE processing scheme gave the motivation for a reprocessing of the data starting in January 1996. The processing followed the latest IERS 2010 conventions (Petit and Luzum, 2010).

The processing until May 2003 has started from RINEX. For the period until end of 2008 an existing set of pre-processed GPS/GLONASS observation files from a previous reprocessing have been reused. Starting with 2009 the screened observation files from the operational CODE processing were taken. Note, that for the full time span starting in May 2003 the GLONASS ambiguity resolution algorithm has been applied. A detailed description of the used models is given in ftp://ftp.unibe.ch/aiub/REPRO_2011/CODE_REPRO_2011.ACN.

Table 5: CODE reprocessing products available through anonymous ftp.

CODE *final* products available at ftp://ftp.unibe.ch/aiub/REPRO_2011/CODE/yyyy/

<code>yyyy/CODwwwd.EPH.Z</code>	CODE final GNSS orbits, correspond to our official IGS orbit product
<code>yyyy/CODwww7.ERP.Z</code>	CODE final ERPs belonging to the final orbits, values for the full week
<code>yyyy/CODwww7.SNX.Z</code>	CODE weekly SINEX product

Note that more results are available in Bernese (version 5.2) specific formats in ftp://ftp.unibe.ch/aiub/REPRO_2011/BSWUSER52/yyyy/.

The reprocessing did include atmospheric pressure loading (APL) deformation from Wijaya et al. (2011). It has been introduced with scaling factors for each station. The products from this reprocessing made available at ftp://ftp.unibe.ch/aiub/REPRO_2011/ (see Tab. 5) are generated without correcting for the APL effect by enforcing the scaling factor to zero.

There are plans to extend the list of products by clock corrections (starting with 2008 also for GLONASS).

References

- Dach, R., G. Beutler, H. Bock, P. Fridez, A. Gäde, U. Hugentobler, A. Jäggi, M. Meindl, L. Mervart, L. Prange, S. Schaer, T. Springer, C. Urschl, and P. Walser. *Bernese GPS Software Version 5.0*. Astronomical Institute, University of Bern, Bern, Switzerland, jan 2007. URL <http://www.bernese.unibe.ch/docs/D0CU50.pdf>. User manual.
- Dach, R., R. Schmid, M. Schmitz, D. Thaller, S. Schaer, S. Lutz, P. Steigenberger, G. Wübbena, and G. Beutler. Improved antenna phase center models for GLONASS. *GPS Solutions*, 15(1):49–65, 2011. doi: 10.1007/s10291-010-0169-5.
- Dilssner, F., R. Dach, R. Schmid, T. Springer, and R. Zandbergen. Updating the IGS processing standard: new GLONASS satellite antenna corrections for igs08.atx. In *EGU General Assembly*, Vienna, Austria, April 2011. Poster.
- Hugentobler, U., M. Meindl, G. Beutler, H. Bock, R. Dach, A. Jäggi, C. Urschl, L. Mervart, M. Rothacher, S. Schaer, E. Brockmann, D. Ineichen, A. Wiget, U. Wild, G. Weber, H. Habrich, and C. Boucher. CODE IGS Analysis Center Technical Report 2003/2004. In K. Gowey, R. Neilan, and A. Moore, editors, *IGS 2004 Technical Reports*, pages 40–51, Jet Propulsion Laboratory, Pasadena, California, USA, 2008. IGS Central Bureau.
- Petit, G. and B. Luzum (Eds). IERS Conventions (2010). IERS Technical Note 36, Bundesamt für Kartographie und Geodäsie, Frankfurt am Main, 2010. URL <http://www.iers.org/IERS/EN/Publications/TechnicalNotes/tn36.html>.
- Meindl, M. *Combined Analysis of Observations from Different Global Navigation Satellite Systems*, volume 83 of *Geodätisch-geophysikalische Arbeiten in der Schweiz*. Schweizerische Geodätische Kommission, 2011. ISBN: 978-3-908440-27-7.
- Schaer, S. and M. Meindl. *Multi-GNSS Ambiguity Resolution Algorithms*, chapter Commission 4: Positioning and Applications, pages 95–96. Swiss National Report on the Geodetic Activities in the years 2007–2011 to the XXV General Assembly of the IUGG, Melbourne, Australia, 28 June — 7 July 2011. Swiss Geodetic Commission, 2011.

Wijaya, D.D., J. Böhm, H. Spicakova, M. Schindelegger, M. Karbon, D. Salstein, and H. Schuh. Determination of atmospheric pressure loading corrections based on a new concept of reference pressure. *Journal of Geodesy*, 2011. to be submitted.

All publications, posters, presentations of the *Satellite Geodesy* research group at AIUB are available at www.bernese.unibe.ch/publist.

NRCan Analysis Center Report for 2005-2011

B. Donahue, R. Ferland, R. Ghoddousi-Fard, F. Lahaye, Y. Mireault

Natural Resources Canada, Geodetic Survey Division
615, Booth Street, Ottawa, ON, Canada K1A 0E9
Brian.Donahue@nrcan.gc.ca

1 Introduction

The NRCan (formerly EMR) Analysis Center (NRCan-AC) contribution to the International GNSS Service began in the early days of the IAG service. The day-to-day operations of the analysis center are performed by staff in the Geodetic Survey Division (NRCan-GSD) of the Canada Center for Remote Sensing within the Natural Resources department of the Canadian federal government. The NRCan-GSD is responsible for the maintenance of the national horizontal, vertical and gravitational reference frames as well as providing the means of accessing these data.

This technical report will address in a first section the major product changes and events that occurred within the NRCan-AC since the last issue of IGS Technical Reports. A second section will address the strategies used for the generation of the current and planned products for submission to the IGS and the larger community.

2 2005–2011 Review

2.1 Major Products Changes

The major changes to the NRCan-AC products are listed in Table 1 in chronological order. Readers are referred to the Analysis Coordinator web site (<http://acc.igs.org>) for historical combination statistics of the NRCan-AC products.

Table 1: Major changes to NRCan-AC processing strategy since 2005

Calendar Date	GPS Wk (day)	Product	Change description
2005 may 16	1323 (1)	Ultra-Rapid	Bernese v5.0 (from v4.2)
2006 sep 03	1391 (0)	Rapid/Final	Satellite clocks at 30 second interval
2006 oct 21	1397 (6)	Ultra-Rapid	EMU GPS clocks rough alignment to GPS time
2006 oct 31	1399 (2)	Ultra-Rapid	Production of 5-minute GPS clocks
2006 nov 05	1400 (0)	Ultra-Rapid Rapid/Final	Absolute phase centers and IGS05 reference frame
2007 jan 24	1411 (3)	Ultra-Rapid	Hourly production of EMU
2007 mar 04	1417 (0)	Final	24h satellite orbital arc (from 30h = 3+24+3)
2007 oct 10	1448 (3)	Ultra-Rapid	Production of 30-second GPS clocks
2008 jul 28	1490 (1)	Rapid/Final	Gipsy-Oasis v5.0 and GMF tropospheric mapping function
2009 oct 11	1553 (0)	Rapid/Final	10 degrees elevation cutoff (from 15 degrees)
2009 oct 15	1553 (4)	Rapid/Final	IERS03 sub-daily tide model (from IERS96)
2010 apr 20	1580 (2)	Ultra-Rapid	CC2nonCC correctly applied
2011 apr 17	1632 (0)	Ultra-Rapid Rapid/Final	IGS08 (from IGS05)
2011 may 22	1637 (2)	Rapid	Bernese GPS+GLONASS solution GPS submitted for IGR combination (IGS Mail #6410)
2011 jul 18	1645 (1)	Rapid	ERP file LOD print format correction
2011 sep 11	1653 (0)	Final	Bernese GPS+GLONASS solution GLONASS submitted to IGLOS comb

2.1.1 Ultra-Rapid Orbit and Clock Products

During the 2005 to 2011 period, the NRCan-AC continued its development and its delivery of Ultra Rapid products (EMU) to IGS and to support NRCan-GSD services such as CSRS-PPP (NRCan online GNSS Processing Service) and HPGPS.C (NRCan real-time

wide area GPS Corrections). Several changes were implemented to our strategy as can be seen in Table 1. The most important changes are related to the production of 30-second clocks along with the hourly availability of EMU products with a delay of less than 90 minutes after the last observation. This allowed offering users of the CSRS-PPP service a near real-time GPS processing capability with a maximum delay of 90 minutes.

One bug correction in our Ultra-Rapid clock production deserves further attention. From the end of 2008 to the end of April 2010 and due to an unfortunate implementation error, the program CC2nonCC (IGS Mail #2827), which ensures consistency of precise satellite clock information with P1/P2 code measurements, was not applied to stations that needed it. The quality of the clock products during that period was not affected, in terms of impact on positioning. However, the comparison of EMU clocks with respect to IGR would show a scatter of up to 0.2 ns to 0.4 ns, depending on how many such stations were included in our processing.

2.1.2 Rapid and Final Products

As can be seen in Table 1, several modifications were also implemented to the NRCan-AC Rapid and Final products. Besides the estimation of 30-sec satellite clocks in September 2006, the most important changes were the switch of software from Gipsy-Oasis (Webb and Zumberge, 1995) to Bernese (Dach et al., 2007) for the generation of Rapid products and the start of our contribution of Final GLONASS solutions to IGLOS. Details of the new Rapid strategy are described in section 3.3.

2.1.3 Real-Time Products

The NRCan-GSD has been processing real-time GNSS data since 1996, when it started processing 4 real-time Canadian stations using in-house software and systems developed in support of a pseudorange-based wide-area correction service. As data streaming stations were added over the years, the service evolved from a strictly Canadian to a North-American coverage service. In the early 2000's, NRCan-GSD began development of its next generation correction service based on pseudorange and carrier-phase observations. These prior developments put NRCan-GSD in a good position to start contributing real-time orbital and clock corrections to the IGS Real-Time Working Group for comparison and combination. The system is currently drawing on tracking data from the Real-Time IGS network as well as Canadian permanent real-time stations to generate global corrections based on real-valued ambiguities. The system and its future developments are described in Section 3.1.

2.2 Other Major Events

During the years 2008 and 2009 the NRCan-AC took part in the reanalysis project (repro1) of historical GPS tracking data for the years 1994 to 2008, both as contributor of a solution (em1) and as the repro1 reference frame coordination and combination center. The objective for repro1 was for all analysis centers to estimate the products in a consistent reference frame (IGS05) using an agreed-upon set of the latest models, methodologies and conventions. The NRCan AC solutions included all core IGS products for the years 1995 to 2008. Table 2 summarizes the models used for the NRCan-AC repro1 products generation.

This was the first such effort being conducted at NRCan-GSD and was done using JPL's Gipsy-Oasis II v5.0 software (Webb and Zumberge, 1995) on 2 Linux servers with 4 quad core CPUs (32 CPUs in total). The NRCan-AC solutions included daily satellite orbits and clocks, daily earth rotation parameters, daily station clocks, and weekly station positions as well as satellite phase center Z-offsets. Due to the time constraints for this project, one major change was implemented relative to the normal NRCan-AC production solution. The repro1 solutions were independent 24h daily solutions with orbits initialized from original IGS Final solutions and bulletin B ERPs. In comparison, the normal production NRCan-AC solutions use the previous day solution to initialize the orbits and ERPs. The complete project took 15 months for ≈ 5000 daily solutions including reruns.

After more than a decade, the Reference Frame coordination role was transferred in February 2010 (wk 1566) from NRCan-GSD to the Institut géographique national (IGN), France. In this essential IGS role, NRCan-GSD operated the weekly combination of weekly station coordinates, daily ERPs and weekly implicit apparent geocenter position

Table 2: NRCan repro1 model summary

Parameter	NRCan repro1
Observations	UD Iono-free phase and range
Elev Cutoff	10 deg
Daily Arc	24 h
Subdaily EOPs	IERS96
2nd order Iono	None
Earth Albedo	None
SRP IIR/IIA	Table Interpolation/GSPM-98
Antenna Calibrations	igs05.atx (Offset and PCVs)
Tropo Mapping Function	GMF
Satellite Z-offset	Estimated
Solid Earth Tide	IERS2003
Pole Tide	IERS2003
Yaw Rates	Nominal + Estimate

from some 8 to 9 analysis centers (COD, EMR, ESA, GFZ, GRG, JPL, MIT, NGS, SIO) using 6 to 7 independent analysis software packages along with 2 Associate Analysis Centers (MIT, NCL) contributing weekly combinations of the above. The transfer to IGN was carefully implemented overlapping one year of weekly SINEX combinations from the two institutions. Table 3 provides a summary of key Reference Frame Working Group activities between 2005 and 2010.

Table 3: Key Reference Frame coordination activities for 2005-2010

- | | |
|-------------|--|
| 2005 | <ul style="list-style-type: none"> • The effect of updating from relative to absolute antenna phase center corrections was analyzed using AC contributions. This effect was most noticeable in the height component which for reference frame purposes links directly into the scale. It also caused a discontinuity on all SINEX combined products. The use of relative phase center was causing a 3 ppb bias in IGb00 while the use of absolute antenna phase center reduced the bias to less than 1 ppb in IGS05. • As the time span of the coordinates series and the number of stations did increase so did the number of discontinuities. Equipment changes did cause most of the discontinuities. The detection of small discontinuities was also found to be subjective. |
| 2006 | <ul style="list-style-type: none"> • Weekly station coordinates for 335 stations (for the period 1996–2005), daily ERP’s (for the period 1999–2005) and weekly apparent geocenter (for the period 1999–2005) were contributed to IERS for the realization of ITRF2005. • A subset (132) of the contributed stations to ITRF05 was selected to realize IGS05, which became official at the end of 2006. At that time, the RMS between the IGS05 and the IGS combined weekly solutions was 2mm horizontally and 6mm vertically. |
| 2007 | <ul style="list-style-type: none"> • The reprocessing of the IGS historical data (1994–2007) became necessary to provide fully consistent IGS products. A reprocessing test campaign was organized to prepare for this major effort. COD, EMR, GFZ, MIT, NGS and SIO did participate. |
| 2008 | <ul style="list-style-type: none"> • The ACs (COD, EMR, ESA, GFZ, GTZ, JPL, MIT, NGS, PDR, SIO, ULR) started to provide weekly reprocessed solutions going backward in time. By the end of the year, preliminary combined solutions were available for the period 2003–2007. |
| 2009 | <ul style="list-style-type: none"> • By the end of the year, all ACs reprocessed solutions were completed. They were gradually combined and updated as needed. Weekly solutions for over 900 stations were provided by the ACs. • A contribution of the IGS weekly official and reprocessed combinations to ITRF2008 was also provided to IERS at the beginning of 2009. This contribution was gradually extended to finally reach the period 1997–2009.5 by August 2009. 560 stations were provided to IERS for the ITRF08 realization. Several exchanges of technical information with IGN helped for an upcoming smooth transition of the RFWG responsibility |
| 2010 | <ul style="list-style-type: none"> • The transfer of the responsibilities to IGN for the Reference frame working group activities was finalized by mid-January. The final submission of the combined reprocessed solutions (1994–2007) was made to CDDIS in the spring. |

3 Current Status and Future Work

Statistics of the combination/comparison of the various NRCan–AC products are given in Table 4 for years 2010 and 2011. The Ultra–Rapid products are given for the estimated portion and a few prediction time span with respect to the IGS Rapid products in terms of median satellite RMS. The comparison of NRCan–AC Rapid GPS, Final GPS and Final GLONASS submissions are the median over all RMS with respect to the respective IGS combinations, as computed in the Analysis Center Coordinator combination reports. The reader should note the Final GLONASS were only available for the last 112 days in 2011.

Table 4: Median Orbit and Clock RMS of NRCan–AC products compared to IGS Combinations for years 2010 and 2011

Product	Orbits (cm)		Clocks (ns)	
	2010	2011	2010	2011
EMU estimated portion (24 h) vs IGR	2	2	0.10	0.10
EMU 3 h prediction vs IGR	5	5	0.50	0.45
EMU 6 h prediction vs IGR	5	5	0.72	0.66
EMU 12 h prediction vs IGR	5	5	1.08	1.03
EMU 24 h prediction vs IGR	10	10	2.03	1.99
EMR Rapid vs IGR	2.0	1.2	0.07	0.11
EMR Final vs IGS	1.9	1.9	0.09	0.11
EMX Final vs IGLOS	—	3.1	—	8.45

3.1 Real–Time Products

The real–time computation infrastructure operated at NRCan–GSD consists of two geographically separated production servers in hot stand–by, one server, identical to the production servers, at NRCan facilities for validation of pre–production–level algorithm updates and bug corrections, and finally one server where development occurs. Data streams from some 60 global stations part of the Real–Time IGS network, supplemented with a few of Canadian stations, are multicast on a Wide–Area Network to which all servers listen.

The current pseudorange and carrier–phase processing algorithm acquires the GPS station data at 1 Hz, carrying cycle–slip detection at that interval. All stations and satellites clock synchronization error (but one) are estimated at two seconds interval, along with real–valued ambiguities and a wet tropospheric delay at each station as a process noise. The station coordinates are fixed at their epoch IGS08 value and the satellite positions are obtained from the NRCan–GSD Ultra–Rapid orbit predictions produced hourly (see section 3.2). The satellite positions and clock synchronization errors are transmitted over

Internet as differences with respect to current broadcast satellite ephemerides parameters in a modified RTCA format (NRCAN, 2003), which carries corrections with a 4mm resolution (compared to the FAA-WAAS specification of 12.5 cm). Two other correction streams are produced in the new state-space representation message format under development at the Radio Technical Commission for Maritime Services Special Committee 104 (www.rtcn.org): one where all GPS-specific messages are produced and a second stream tailored to the IGS Real-Time pilot project requirements.

Current development work include the implementation of the Decoupled Clock Model (Collins et al., 2008) for integer ambiguity resolution and the incorporation of GLONASS data in view of a multi-GNSS real-time correction service.

3.2 Ultra-Rapid GPS&GLONASS Products

NRCAN-GSD is currently working on a strategy to produce GNSS hourly orbit products. The method is very similar to the current implementation of our GPS only Ultra Rapid strategy already described in Mireault et al. (2008). The processing of both GPS and GLONASS data is done the same way as in our Rapid GNSS solutions. The development is nearly completed and parallel testing will soon begin in 2012. GNSS clock estimation development will most likely start in the middle of 2012. Full implementation of true Ultra Rapid GNSS orbits and clocks should be available by early 2013. One major drawback of producing GNSS products is the increase in processing time which might prevent us from delivering hourly products. A longer update interval and/or a longer delay may result from the addition of the GLONASS constellation.

3.3 Rapid GPS&GLONASS Products

The new Bernese Rapid products are run daily and consist of the usual SP3 format files (orbits and clocks at 15-minute intervals), RINEX clock format files (30-second satellite clocks) and ERP. Both GPS and GLONASS data are processed simultaneously using the Bernese v5.0 software (Dach et al., 2007). Resulting products are sent to IGS and used internally as well. Table 5 is a summary of the strategy used for our Rapid solution.

3.4 Final GPS&GLONASS Products

In September 2011, NRCAN started contributing to the Final IGLOS combination. For the time being and until further developments are in place, a similar approach to our Rapid GNSS product generation is used. Mainly, station coordinates are highly constrained and not completely loose as per the Final IGS conventions. However, our strategy was accepted by the Analysis Center Coordinator and further work will allow us to use the proper conventions. Note that our Gipsy-Oasis GPS-only solutions are still being used

Table 5: Rapid GNSS solution strategy

Software	Use of Bernese 5.0
Network	Around 120 stations (3 clusters) and 60 stations (1 cluster) are used for orbit and clock estimation respectively
Observations	GPS and GLONASS observations are always processed together: Orbits: double-difference phase observations Clocks: zero-difference code and phase observations
A priori orbits	NRCan-AC Ultra Rapid (EMU), IGU/IGV or previous day predictions
A priori ERP	NRCan-AC Ultra Rapid (EMU)
Troposphere	3 h zenith delays and 24 h horizontal gradients
Ambiguities	GPS only in orbit estimation ($\approx 80\text{--}85\%$ resolved) GLONASS ambiguities remain float
Orbits and ERP	Produced using a sliding two 1-day Normal Equation (NEQ)
Orbits	Produced first followed by a second run for the clock estimation (orbits and ERP held fixed)
Clocks	Estimated at 5-minute intervals and then interpolated at 30-second intervals

for the Final GPS combinations. The new Bernese solution is strictly used for IGLOS and is called EMX. The orbits are rotated (RX, RY and RZ) to align them to our Gipsy–Oasis Final GPS solutions

In preparation for NRCan’s contribution to the 2nd IGS reanalysis campaign, the Final GPS product strategy will be updated in mid–2012. The major strategy change will be to run independent 24h daily solutions with orbits initialized from IGS rapid and Bulletin A ERP. The current NRCan–AC strategy is to use the previous day Final solution to initialize the orbits and ERP. Many other model changes will be made at this time and are summarized in Section 3.5.

3.5 Participation in the 2nd IGS Reprocessing Campaign

Beginning in mid–2012 the NRCan–AC will start re–estimating the core IGS products for the years 1994 to 2012. This 2nd IGS reprocessing campaign will be called repro2 and the NRCan–AC products will be named em2. The plan for repro2 is for all ACs to estimate the products in a consistent way using the latest models and methodology. Table 6 summarizes the major changes to the NRCan–AC solution between repro1 and repro2.

The plan for repro2 at the NRCan–AC is to begin estimating solutions in late 2012 and to process at a rate of ≈ 2 years/month. This will allow for the completion of the project before the end of 2013.

Table 6: Comparison of repro1 and repro2 NRCan–AC solutions

	NRCan repro1 (em1)	NRCan repro2 (em2)
Software	JPL's GIPSY-OASIS II,V5.0	JPL's GIPSY-OASIS II, V.6.1
Satellite System	GPS Only	GPS Only
Terrestrial Ref Frame	IGS05	IGS08
Antenna Calibrations	Igs05.atx	Igs08.atx
SRP Model IIR/IIA	Table /GSPM-98	GSPM-2010
Nutation Model	IAU 1980	IAU 2000A
Earth Albedo	None	Applied
Gravity Field	JGM3	EGM2008
Solid Earth Tide	IERS 2003	IERS 2010
Pole Tide	IERS 2003	IERS 2010
Subdaily EOPs	IERS 1996	IERS 2010
2nd Order Iono	None	Applied
SINEX Solution	7 d	1 d
Satellite Clock Rate	5 minute	30 second

3.6 Ionosphere

After a long interruption, the NRCan–AC contribution to the Final IGS ionospheric vertical TEC grid product is planned. In addition to our current process generating regional vertical TEC grid using spherical cap harmonic analysis (Ghoddousi–Fard et al., 2011) a process is undergoing to map vertical TEC using spherical harmonic expansion on a global geomagnetic reference frame. The process can be initialized using a global grid derived from International Reference Ionosphere (IRI2007). Vertical TEC values are estimated on a single layer model from GPS inter–frequency, phase–smoothed, geometry–free pseudorange measurements corrected for satellite and receiver differential code biases. The planned global daily TEC grid generation for contribution to the IGS products will complement our near–real–time global TEC grid generation currently under preliminary test.

References

- Collins, P., F. Lahaye, P. Héroux and S. Bisnath. Precise Point Positioning with Ambiguity Resolution using the Decoupled Clock Model. *Proceedings of ION-GNSS-2008*, Savannah, Georgia, 16-19 September, pp.1315–1322, 2008.
- Dach, R., U. Hugentobler, P. Fridez and M. Meindl. *Bernese GPS Software Version 5.0*. AIUB, Astronomical Institute, University of Bern, January 2007.

Ghoddousi-Fard, R., P. Héroux, D. Danskin, and D. Boteler. Developing a GPS TEC mapping service over Canada. *Space Weather*, 9:S06D11, 2011. doi: 10.1029/2010SW000621.

Mireault, Y., P. Tétreault, F. Lahaye, P. Héroux and J. Kouba. Online Precise Point Positioning. *GPS World*, 19(9):59–64, September 2008.

NRCan. *GPS.C Interface Control Document, v. 3.7*. 2003.

Webb, F.H. and J.F. Zumberge. *An introduction to Gipsy-Oasis II*. Jet Propulsion Laboratory, July 17-21, 1995.

The ESA/ESOC IGS Analysis Centre

*T. A. Springer, W. Enderle,
L. Agrotis , F. Dilssner, C. Flohrer, F. Pereira,
N. Romero, R. Zandbergen*

European Space Operations Centre
Darmstadt, Germany

1 Introduction

The IGS Analysis Centre of the European Space Agency (ESA) is located at the European Space Operations Centre (ESOC) in Darmstadt, Germany. The ESOC Analysis Centre has been involved in the IGS since its very beginning in 1992. In this report we give a summary of the IGS related activities at ESOC in the recent years, roughly since 2004. It focuses on the major changes in the routine processing during this period of almost a decade. It also addresses some of the activities at ESOC which are not directly IGS related but which rely heavily on the ESA IGS products. This report will demonstrate that the the ESA/ESOC Analysis Centre has been very active and very succesful in the recent years. Besides being an IGS analysis centre we have also become an analysis center of the IDS and ILRS services. Furthermore, besides the routine product generation for the IDS, IGS, and ILRS we are fully ready for the Galileo system and are capble of processing all LEO observation types. This latter is important as it enables us to do precise orbit determination of all LEO satellites in particular the Sentinel satellites of the GMES.

2 ESA IGS Analysis

2.1 ESA Products

The ESA IGS Analysis centre contributes to all the core IGS analysis centre products, being:

- Final GNSS (GPS+GLONASS) products
 - Provided weekly. Normally on Friday after the end of the observation week.
 - Based on 24 hour solutions using 150 stations

- True GNSS solutions simultaneously and fully consistently processing of GPS and GLONASS measurements. Means a total of around 55 satellites.
- Consisting out of Orbits, Clocks, coordinates, Ionosphere, and EOPs
- Rapid GNSS (GPS+GLONASS) products
 - Provided daily for the previous day.
 - Available within 3 hours after the end of the observation day
 - Based on 24 hour solutions using 110 stations
 - True GNSS solutions simultaneously and fully consistently processing of GPS and GLONASS measurements. Means a total of around 55 satellites.
 - Consisting out of Orbits, Clocks, coordinates, Ionosphere, and EOPs
- Ultra-Rapid GNSS (GPS+GLONASS) products
 - Provided 4 times per day covering 48 hour intervals until 0, 6, 12, and 18 hours UTC.
 - Available within 3 hours after the end of the observation interval
 - Based on 24 hours of observations using 110 stations
 - True GNSS solutions simultaneously and fully consistently processing of GPS and GLONASS measurements. Means a total of around 55 satellites.
 - Consisting out of Orbits, Clocks, Ionosphere, and EOPs
 - Containing a 24 hour estimated interval and a 24 hour predicted interval.

Besides these core products ESA is very active in different working groups. Most notably are our efforts in the Real-Time pilot project where besides being one of the analysis centres we ESA is also responsible for the analysis centre coordination. However, also our efforts in the scope off the antenna calibrations and satellite orbit modeling working groups are not insignificant. Furthermore, we will significantly contribute to the IGS MGEX efforts.

An up to date description of the ESA IGS Analysis strategy may be found at:
<ftp://dgn6.esoc.esa.int/products/esa.acn>

2.2 ESA Reprocessing

ESA has also participated in the first IGS reprocessing efforts (repro1) for the IGS contribution to the realisation of the International Terrestrial Reference Frame 2008 (ITRF08). Thanks to efficiency and speed of the NAPEOS software (see development section) ESOC was able to contribute to this very demanding effort despite the limited computational power available to our group at ESOC. Thanks to the fact that NAPEOS can process a full day of GNSS data in less the 60 minutes the reprocessing effort could be done on a relatively simple Linux-PC within a reasonable amount of time. For this reprocessing effort ESA has processed all historic GNSS data of the IGS from 1994 to 2008 but the results in 1994 were considered to be off to poor quality to submit.

Meanwhile ESA has repeated the reprocessing using the ITRF08 station coordinates and the corresponding IGS08 antex corrections for the receiver and transmitter antennas. In this reprocessing the years 1995 to 2008 are done using only GPS observations, but from 2009 the reprocessing does fully include the GLONASS observations and thus are true GNSS solutions. The products from the first ESA official reprocessing efforts based on the ITRF05 reference frame are available from the official IGS data centres. The most recent ESA reprocessing products, currently based on the ITRF08, are available from our ftp: <ftp://dgn6.esoc.esa.int/igs/repro2>

These are our preliminary products for the second IGS reprocessing effort (repro2) and thus the products are labelled "es2". The products from the first reprocessing were, consequently, labelled "es1". Currently only the orbit products are made available. Other products are available on request. An interesting difference between our es1 and es2 reprocessing is that, as mentioned before, from 2009 our es2 products are GNSS products. Also our es2 products do contain 30second clock estimates. We generate these high-rate clock products because we are also very active in processing GNSS data from Low Earth Orbiting (LEO) receivers (see later section). For LEO processing high-rate clocks are very much needed to get accurate orbits based when using the well-known PPP technique. At present it is unclear whether we as ESA will make these high-rate clocks freely available.

Last but not least it is worthwhile to mention that besides participating in the IGS reprocessing efforts ESA also contributed to the reprocessing efforts of the IDS and the ILRS. This represents a rather unique achievement in that one single software version, NAPEOS, contributed to the ITRF solutions of three different space geodetic techniques.

2.3 ESA Product Highlights

One of the highlights of the ESA Analysis Centre products is that they are one of the best products available from the individual IGS analysis centres. Secondly the ESA products are one of the few complete GNSS products. In fact ESA was the first IGS analysis centre to provide a consistent set of GNSS orbit and clock products. These product constituted the very first products that could, and are, used for true GNSS precise point positioning. The sampling rate of the final GPS+GLONASS clock product is 30seconds.

Another special feature of the ESA products is that they are based on completely independent 24 hour solutions. Although this does not necessary lead to the best products, as in the real world the orbits and EOPs are continuous, it does provide a very interesting set of products for scientific investigations as there is no aliasing and no smoothing.

3 ESA Analysis Developments

3.1 NAPEOS Developments

The Navigation Package for Earth Orbiting Satellites, NAPEOS, Springer (2009), has been developed at ESOC over the scope of many years. It started as a rewrite, from Fortran 77 into Fortran 90, for the flight dynamics section of ESOC of the old Bahn program including all the smaller support programs. After the very successful completion of that task it was decided to add the GNSS capabilities to NAPEOS as well. Although initially foreseen to be finished in 2004 it effectively took until the end of 2007 before NAPEOS was fully ready and capable to be used for the high accuracy IGS service.

In January 2008 ESOC started to use NAPEOS for its IGS activities after having tested the software by running a small reprocessing effort covering the full year of 2007. After the introduction of NAPEOS for the IGS routine processing the NAPEOS developments did not stop, on the contrary the development speed actually increased. Because NAPEOS was used more and more in the navigation support office at ESOC more and more requirements were put on the system but also more resources for development became available. Over the time period from 2008 to 2010 all projects within the navigation support office of ESOC switched from the old Bahn software to the meanwhile clearly superior NAPEOS software. Besides being more accurate, more efficient, and much faster, NAPEOS also is much easier to learn, configure, and operate. Over the years since 2008 the versatility as offered by the NAPEOS software has greatly enhanced the abilities and productivity of the navigation support office.

In 2008 the IGS activities started with NAPEOS version 3.0, whereas meanwhile (2012) we are working on the release of NAPEOS version 3.7. Despite the very high quality of the current NAPEOS version 3.6., the version 3.7 will bring significant improvements and enhancements. In particular the integer ambiguity resolution was significantly improved now giving rise to almost always 98% of resolved ambiguities compared to 90% today. Furthermore, the integer ambiguity resolution was enhanced in such a way that it can now also include LEO GNSS receivers and fix LEO–LEO but also Station–LEO ambiguities. And in version 3.7 the Ionosphere estimation is incorporated into the NAPEOS software. Last but not least some significant further speed improvements were achieved. For our IGS type of processing an improvement of about 25% was achieved whereas for our LEO processing a speed improvement of about 50% (meaning a factor of 2 faster!) was achieved. With these speed improvements NAPEOS is now capable of processing an IGS type of solution (150 stations, 55 satellites) including a LEO (e.g. JASON) in less than 2 hours on a single core of a standard PC. An amazing achievement!

Thanks to the excellent quality of the NAPEOS software we were one of the first GNSS centres world-wide that noticed and documented the anomaly of the SVN 49, Springer and Dilssner (2009). Our efforts contributed significantly to the understanding of the problem

with this satellite. Unfortunately, as it turned out, the problem cannot be resolved and the satellites has to be considered to be lost.

3.2 The GLONASS–M satellite yaw–attitude model

The proper modelling of the satellites’ yaw–attitude is a prerequisite for high–precision Global Navigation Satellite System (GNSS) positioning and poses a particular challenge during periods when the satellite orbital planes are partially eclipsed. Whereas a lot of effort has been put to examine the yaw–attitude control of GPS satellites that are in eclipsing orbits, hardly anything was known about the yaw–attitude behaviour of eclipsing GLONASS–M satellites. However, systematic variations of the carrier phase observation residuals in the vicinity of the orbit’s noon and midnight points of up to ± 27 cm indicated significant attitude–related modelling issues. In order to explore the GLONASS–M attitude laws during eclipse seasons, we studied the evolution of the horizontal satellite antenna offset estimates during orbit noon and orbit midnight using a technique that we refer to as “reverse kinematic precise point positioning”. In this approach, we keep all relevant global geodetic parameters fixed and estimate the satellite clock and antenna phase centre positions epoch–by–epoch using 30–second observation and clock data from a global multi–GNSS ground station network. The estimated horizontal antenna phase centre offsets implicitly provide the spacecraft’s yaw–attitude. The insights gained from studying the yaw angle behaviour have led to the development of the very first yaw–attitude model for eclipsing GLONASS–M satellites, Dilssner (2010); Dilssner et al. (2011). The derived yaw–attitude model proves to be much better than the nominal yaw–attitude model commonly being used by today’s GLONASS–capable GNSS software packages as it reduces the observation residuals of eclipsing satellites down to the normal level of non–eclipsing satellites and thereby prevents a multitude of measurements from being incorrectly identified as outliers. It facilitates continuous satellite clock estimation during eclipse and improves in particular the results of kinematic precise point positioning of ground–based receivers.

3.3 ESOC contributions to PCO/PCV

Driven by the comprehensive modernization of the GLONASS space segment and the increased global availability of GLONASS–capable ground stations, Springer and Dach (2010), an updated set of satellite–specific antenna phase centre corrections for the current GLONASS–M constellation was determined by processing 84 weeks of dual–frequency data collected between January 2008 and August 2009 by a worldwide network of 227 GPS–only and 115 combined GPS/GLONASS tracking stations. The analysis was performed according to a rigorous combined multi–system processing scheme providing full consistency between the GPS and the GLONASS system. The solution was aligned to a realization of the International Terrestrial Reference Frame 2005. The estimated antenna

parameters are compared with the model values currently used within the International GNSS Service (IGS). It was shown that the z -offset estimates are on average 7 cm smaller than the corresponding IGS model values and that the block-specific mean value perfectly agrees with the nominal GLONASS-M z -offset provided by the satellite manufacturer. It was demonstrated that the orbit quality benefits from the updated GLONASS-M antenna phase centre model and that a consistent set of satellite antenna z -offsets for GPS and GLONASS is imperative to obtain consistent GPS- and GLONASS-derived station heights, Dilssner et al. (2010).

Besides these, rather unique, GLONASS PCO/PCV contributions ESOC has also contributed very significantly to the GPS PCO/PCV understanding. Our unique spherical harmonics approach has proven to be very good and our significant abilities in analysing also GNSS LEO data has allowed us to also play a leading role, together with the Analysis Centre CODE, in the extension of the PCV values from the 14 degrees to the 17 degrees nadir angle range. This extension is of prime importance for accurately processing GNSS LEO data.

4 GNSS LEO Analysis

Driven by the GMES (Global Monitoring for Environment and Security) and GGOS (Global Geodetic Observing System) initiatives the user community has a strong demand for high-quality altimetry products. In order to derive such high-quality altimetry products, precise and homogeneously processed orbits for the altimetry satellites are a necessity. With the launch of the TOPEX/Poseidon mission in 1992 a still on-going time series of high-accuracy altimetry measurements of ocean topography started, continued by the altimetry missions Jason-1 in 2001 and Jason-2/OSTM in 2008. The Navigation Support Office at ESA/ESOC uses its NAPEOS software for the generation of precise and homogeneous orbits referring to the same reference frame for the altimetry satellites Jason-1 and Jason-2. Data of all three tracking instruments on-board the satellites (beside the altimeter), i.e. GPS, DORIS, and SLR measurements, are used in a combined data analysis. About 7 years of Jason-1 data and more than 1 year of Jason-2 data were processed. Our processing strategy is close to the GDR-C standards. However, we estimated slightly different scaling factors for the solar radiation pressure model of 0.96 and 0.98 for Jason-1 and Jason-2, respectively. We used 30 second sampled GPS data and introduced 30 second satellite clocks stemming from ESOC's reprocessing of the combined GPS/GLONASS IGS solution. The fully combined solution (DORIS, GNSS, and SLR) was found to give the best orbit results. We reach a post-fit RMS of the GPS phase observation residuals of 6 mm for Jason-1 and 7 mm for Jason-2. The DORIS post-fit residuals clearly benefit from using GPS data in addition, as the DORIS data editing improves. The DORIS observation RMS for the fully combined solution is with 3.5 mm and 3.4 mm, respectively, 0.3 mm better than for the DORIS-SLR solution. Our orbit solution agrees well with

external solutions from other analysis centres, as CNES, LCA, and JPL. The orbit differences between our fully combined orbits and the CNES GDR-C orbits are of about 0.8 cm for Jason-1 and at 0.9 cm for Jason-2 in the radial direction. In the cross-track component we observe a clear improvement when adding GPS data to the POD process. The 3D-RMS of the orbit differences reveals a good orbit consistency at 2.7 cm and 2.9 cm for Jason-1 and Jason-2, Flohrer et al. (2011) Our resulting orbit series for both Jason satellites refer to the ITRF2005 reference frame and are provided in sp3 file format on our ftp server.

For Jason-1 at: `ftp://dgn6.esoc.esa.int/jason1`

For Jason-2 at: `ftp://dgn6.esoc.esa.int/jason2`

5 Multi-technique Analysis

The NAPEOS multi-technique capabilities allow combining the observations from the different techniques on the observation level. One obvious major benefit of this is that it ensures that identical models are used for all technique and thus all the data is processed homogeneously. A second major benefit is that the combination on the observation level offers the unique possibility to tie the techniques together not only through the terrestrial local site ties, at collocated sites, but also through their space ties, i.e., the physical distances of the instruments as mounted on the satellite spacecraft body. Here it is worthwhile to point out that these space ties are not used when generating the ITRF solutions!

At ESOC we have already demonstrated that the SLR observations of the GPS and GLONASS satellites significantly strengthen the ties between those two observation techniques. Also it is well known that the SLR observations contribute significantly to the DORIS solutions. The strongest tie between the three techniques, however, is offered by the JASON-1 and -2 satellites which provide observations from all three techniques: DORIS, GPS, and SLR. Recent enhancements and efficiency improvements of the NAPEOS software have made it possible to include GNSS data from LEO satellites in a full IGS final run, i.e., a GNSS solution using 150 GNSS stations and all (≈ 60) GNSS satellites; a rather unique capability. The NAPEOS multi-technique capabilities make it an excellent tool for Space Geodesy in general and GMES and GGOS in particular. Especially the combination of the three space geodetic techniques on the observation level including LEO satellites that have observations from all three techniques, like e.g. JASON-1 and -2, does offer an enormous strengthening of the ties between the different observation techniques. At ESOC we have only just begun to uncover this potential!

It should be mentioned that with significant NAPEOS abilities we contribute to the efforts of the IERS working group for Combination on the Observation Level (abbreviated COL, but we prefer to abbreviate it as COOL).

6 Conclusions

6.1 Summary

Over the recent years the Navigation Package for Earth Orbiting Satellites, NAPEOS, as developed and maintained at the European Space Operations Centre (ESOC) of the European Space Agency (ESA) has evolved to a great tool for satellite geodesy. NAPEOS is capable of processing data from all GNSS systems, all DORIS, and all SLR observations. And, NAPEOS is used for generating state of the art products for all three satellite geodesy techniques: IDS, IGS, and ILRS. At ESOC NAPEOS is routinely used for a large number of tasks. Most relevant is the fact that one and the same version of NAPEOS is used for generating the ESOC analysis centre products for the IGS, ILRS, and IDS.

Over the years since 2004 very major changes have taken place with respect to the IGS analysis at ESOC. These changes have made our analysis centre to be one of the best and one of the most complete within the IGS. At the same time we have also contributed significantly to different important aspects of the GNSS technique in general and the IGS in particular. In particular noteworthy are our efforts and achievements as mentioned below.

- Truly combined GNSS processing including Orbits and (30s) Clocks allowing for GNSS precise point positioning
- Attitude model for the GLONASS-M satellites, in particular during the eclipse phases
- Contributions to the IGS antenna working group for the determination of the GNSS satellite PCO and PCV values
- Analysis Centre and Analysis Centre Coordination of the Real-Time Pilot Project
- Efficient, fast, and accurate simultaneous processing of GNSS ground station and LEO data
- Unsurpassed capabilities for multi-technique processing: DORIS, GNSS, and SLR
- Full Analysis Centre in the IDS, IGS, and ILRS

References

- Springer, T. NAPEOS Mathematical Models and Algorithms. DOPS-SYS-TN-0100-OPS-GN, Issue 1.0, Nov 2009. Available at <ftp://dgn6.esoc.esa.int/napeos>
- Springer, T. and F. Dilssner. SVN49 and Other GPS Anomalies — Elevation-Dependent Pseudorange Errors in Block IIRs and IIR-Ms. *InsideGNSS*, July/August 2009. Available at <http://www.insidegnss.com/node/1574>

- Springer, T. and R. Dach. Innovation: GPS, GLONASS, and More. *GPS World*, June 1, 2010. Available at <http://www.gpsworld.com/gnss-system/glonass/innovation-gps-glonass-and-more-10007>
- Dilssner, F. GPS IIF-1 satellite antenna phase center and attitude modeling. *InsideGNSS*, September 2010a. Available at <http://www.insidegnss.com/auto/sep10-Dilssner.pdf>
- Dilssner, F., T. Springer, C. Flohrer, and J. Dow. Estimation of phase center corrections for GLONASS-M satellite antennas. *Journal of Geodesy*, 84(8):467–480, 2010b. doi: 10.1007/s00190-010-0381-7
- Dilssner, F., T. Springer, G. Gienger, and J. Dow. The GLONASS-M satellite yaw-attitude model. *Adv Space Res*, 47(1):160–171, 2011. doi: 10.1016/j.asr.2010.09.007
- Flohrer, C., M. Otten, T. Springer, and J. Dow. Generating precise and homogeneous orbits for Jason-1 and Jason-2. *Advances in Space Research*, 48(1):152–172, 2011, doi: 10.1016/j.asr.2011.02.017

GFZ Analysis Center of IGS Annual Report for 2011

*G. Gendt, M. Ge, T. Nischan,
M. Uhlemann, G. Beeskow, A. Brandt*

GeoForschungsZentrum Potsdam
Department Geodesy & Remote Sensing
Telegrafenberg A 17, 14473 Potsdam, Germany;
e-mail: gendt@gfz-potsdam.de

1 Summary

Since the last publication of the IGS Annual Report GFZ has enhanced its GPS software to a full GNSS capable software including GLONASS and Galileo. The new version, named EPOS-8, was used in the standard IGS processing starting July 2009.

It should also be mentioned here that during the last reprocessing campaign the IGS network was already analysed with EPOS-8.

2 Products

The list of products provided by GFZ is summarized in Table 1. All the orbit and clock products include estimates for GPS and GLONASS satellites. For the IGS Rapid and Final processing lines the GLONASS data were added starting GPS week 1579 (April 2010). With the start of the generation of IGS Ultra Rapids for GLONASS (GPS week 1603, September 2010) GFZ is contributing to this new IGS product.

The GFZ Final summary report includes the station-wise mean clock offsets between GLONASS and GPS (so-called Inter-Frequency Code Biases, IFB) which are replacing since GPS week 1637 (May 2011) the information provided until that time by BKG in the IGS combination to align the GLONASS broadcast clocks.

Table 1: List of products provided by GFZ AC

Final

gfzWWWD.sp3	Orbits for GPS/GLONASS satellites
gfzWWWD.clk	5–min clocks for stations and GPS/GLONASS satellites
gfzWWW7.erp	
gfzWWW7.snz	
gfzWWW7.sum	Summary file including ISB for GLONASS
gfzWWWD.tro	1–hour ZPD estimates

Rapid

gfzWWWD.sp3	Orbits for GPS/GLONASS satellites
gfzWWWD.clk	5–min clocks for stations and GPS/GLONASS satellites
gfzWWWD.erp	

Ultra (every 3–hours; provided to IGS every 6 hours)

gfuWWWD.sp3	Adjusted and predicted orbits for GPS/GLONASS satellites
gfuWWWD.erp	

3 Processing

EPOS–8 is following the IERS Conventions 2010 (Petit and Luzum, 2010).

In July 2010 the yaw attitude modelling for GLONASS was implemented according to the model provided by ESOC (Dilssner et al., 2011). For the GPS satellites our software keeps unchanged, i.e., the maximum yaw rate is estimated on a daily basis.

The albedo model, using the software provided by (Rodriguez–Solano et al., 2012), was implemented in EPOS–8 with small interface adaptations.

Some details for recent changes are listed in Table 2.

The station network used in the processing is shown in Figure 1. For the IGS Final, Rapid and Ultra Rapid about 200, 110, and 90 sites are used, respectively.

4 Current status of GLONASS Processing

The orbit and clock products are generated from a combined GPS/GLONASS estimation on an operational basis since week 1579.

The clock corrections are consistent to pseudo range and carrier phase observations and are provided with a sampling rate of 300 sec. The selected standard code observable types are

Table 2: Recent Processing changes

Date	IGS	IGR/IGU	Change
2010-04-11	1579		GLONASS data processing for Final
2010-09-26		1603	GLONASS data processing for Ultra
2010-07-08	1590	1592.1	Yaw modelling for GLONASS
2011-12-15	1665	1665.1	Atmospheric Loading S1/S2
2011-12-15	1665	1665.1	Ocean pole tide
2011-12-15	1665	1665.1	Bug fix for negative beta angle in yaw modelling corrected; yaw modelling for IIF added
2012-01-09	1669	1670.1	Albedo/IR/Antenna thrust for GPS&GLONASS
2012-02-13	1674	1674.0	ZPD with 30-min sampling, internally

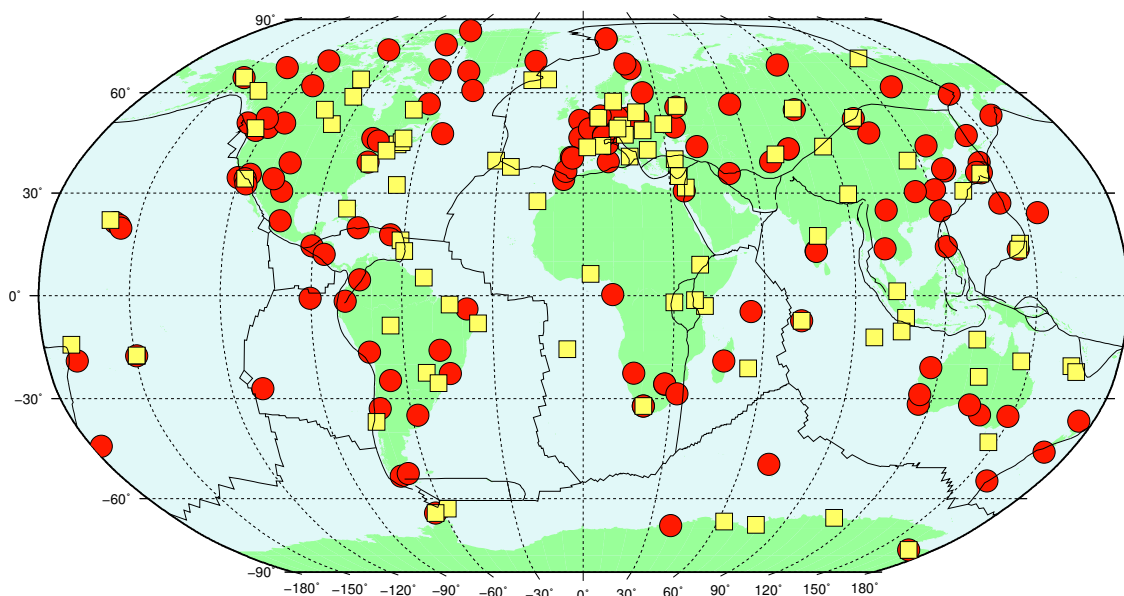
**Figure 1:** Used stations (GLONASS tracking sites are marked with yellow squares).

P1 and P2, C1 is only used if P1 is unavailable, C2 is never used. During Pre-processing the P1C1 Differential Code Biases (DCB) provided by CODE are used within cc2noncc tool. One Inter-Frequency Code Bias (IFB) is introduced per station, frequency channel and day with very loose constraints. For these biases we have no fixed datum definition and the mean of all IFB per station are used as a priori value. Additionally there exists the possibility to set the IFB at one selected station to zero.

During the whole processing chain we apply different IFB handlings: In data cleaning and orbit/clock improvement steps we use one mean IFB per station. Only in the final iteration step we introduce one IFB per station and frequency channel. This handling ends up in a good balance between processing time and solution quality in our parameter estimation of actually 32 GPS+24 GLONASS satellites. The number of used GLONASS stations within our selected network and the approximately needed computation time per day is listed in Table 3.

The orbit quality of GFZ’s GLONASS solution is nicely shown in the weekly Final IGLOS combination (Figure 2) where a good agreement with other ACs in the level of about 2–3 cm is reached.

The experience from two years of GLONASS data processing shows that the “Mean IFB” handling per station during data cleaning steps can cause some problems, if the receiver dependent spreading between the channels is very large. In these cases a lot of observations

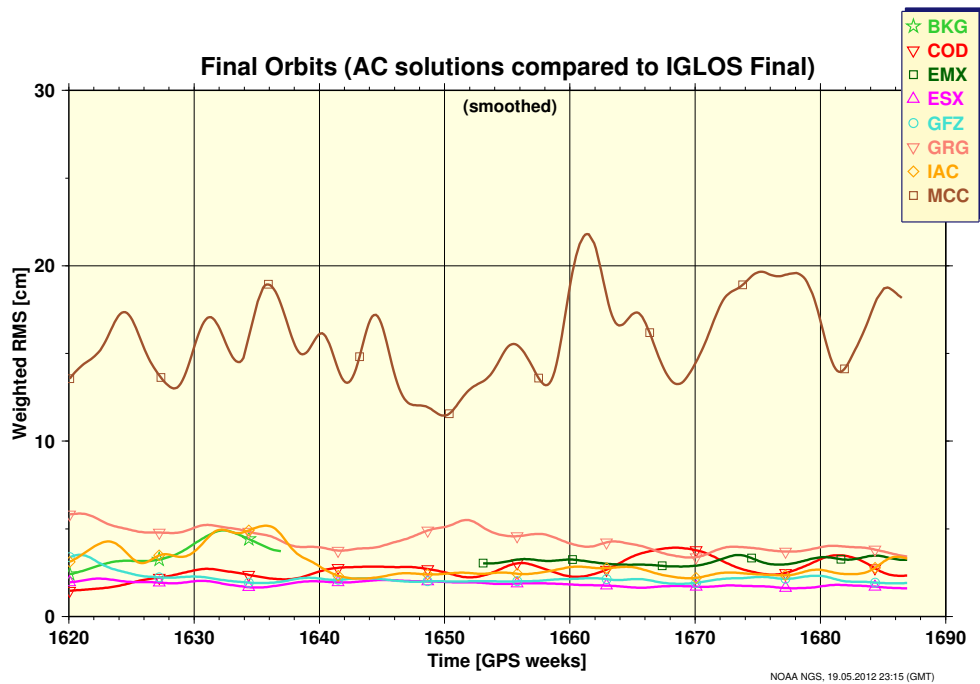

Figure 2: Final GLONASS orbit comparisons.

Table 3: Number of stations and processing time for different kind of GFZ products.

IGS Product	# of sites	# of sites incl. GLO	Duration [h]
Ultra	90	50	≈1
Rapid	110	60	≈2
Final	200	90	≈4

are flagged as outliers during residual screening and finally all GLONASS data of that particular station are rejected. In Figure 3 there are given some examples of different receiver types which are operated at IGS stations. Clearly visible is the good performance of Javad TRE_G3TH, Trimble NETR9 and Leica GRX1200+GNSS hardware in terms of IFB stability and linear behaviour over the channel spectrum with a range of ≈2 m, ≈3 m and ≈7 m, respectively. The spreading at TPS NetG3 equipped stations is obviously non-linear and larger. The station Mendeleevo in Russia (MDVJ) is with up to 20 m fluctuation very conspicuous and GLONASS data are excluded within our processing scheme. The reason for that behaviour is still unknown, but it seems to be station related.

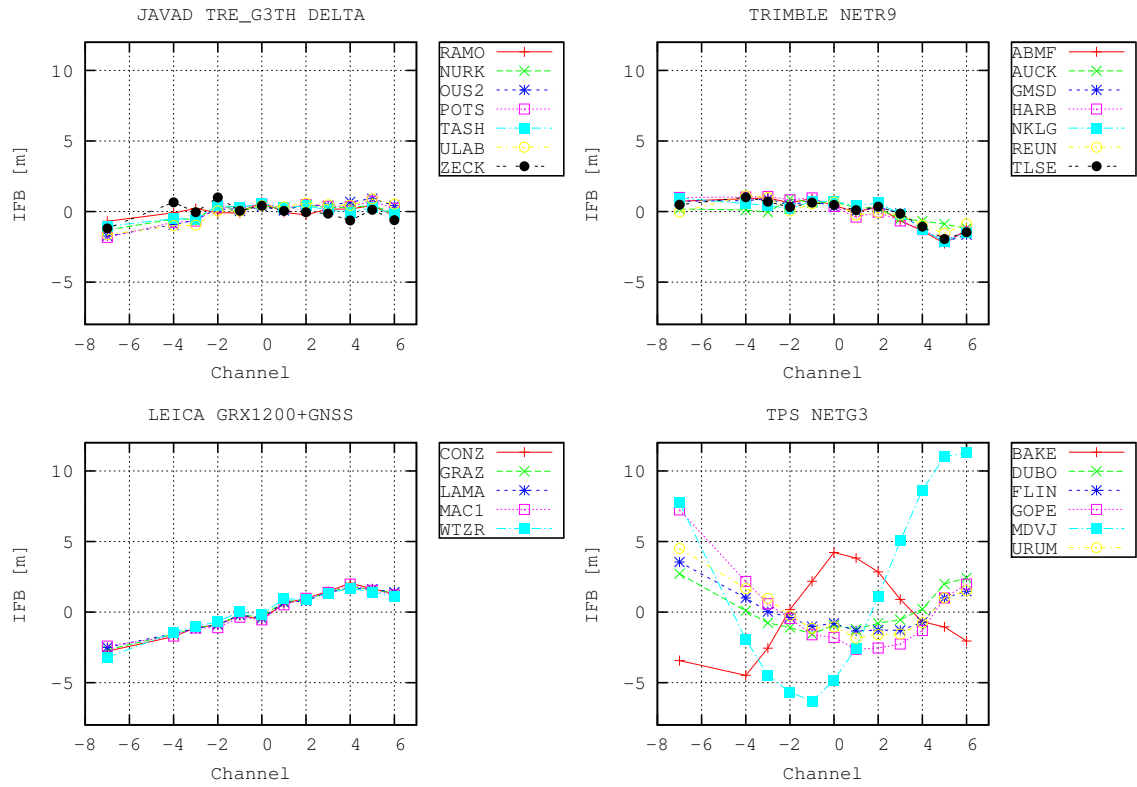

Figure 3: Inter-Frequency Code Biases per receiver type (mean values subtracted).

References

- Petit, G. and B. Luzum (Eds). IERS Conventions (2010). IERS Technical Note No. 36, Verlag des Bundesamtes für Kartographie und Geodäsie, Frankfurt am Main, 2010.
- Rodriguez-Solano, C. J., U. Hugentobler and P. Steigenberger. Adjustable box-wing model for solar radiation pressure impacting GPS satellites. *Advances in Space Research*, 49(7): 1113–1128, Elsevier, ISSN 0273–1177, 2012. doi: 10.1016/j.asr.2012.01.016. (software download from: <http://www.iapg.bv.tum.de/albedo/>).
- Dilssner, F., T. Springer, G. Gienger and J. Dow. The GLONASS-M satellite yaw-attitude model. *Advances in Space Research*, 47(1):160–171, 2011.

GOP IGS Analysis Centre Report 2005–2011

J. Dousa

Geodetic Observatory Pecný,
Research Institute of Geodesy, Topography and Cartography,
Ústecká 98, Zdíby, Czech republic, e-mail: jan.dousa@pecny.cz

1 Introduction

This report summarizes the contribution of Geodetic Observatory Pecný (GOP) of the Research Institute of Geodesy, Topography and Cartography to the International GNSS Service during 2005–2011. The GOP is contributing to the GNSS ultra-rapid product series strongly motivated by its activities in (near) real-time applications. During 2005–2011 various developments were done at GOP analysis centre, which are described in report together with developing new GLONASS contribution. Other related activities like product performance monitoring or experience with the use of IGS combined ultra-rapid products in end-user applications is summarized too.

2 Processing strategy in a nutshell

The GOP orbit determination procedure is based on modified Bernese GPS Software V5.0 (Dach et al., 2007) and in-house system for a flexible use, which is common to all other services provided by GOP. The orbit determination system has been developed as highly efficient based on the analysis of double-differenced observations from last 6-hour data batch, thus avoiding redundancy in observation pre-processing. The final product is generated applying the combination of 6-hour normal equations (NEQs) over last two days. Only the GNSS navigation messages, GNSS observations and predicted Earth rotation parameters (ERPs) are necessary for the initialization. In order to provide overall robustness, the solution consists of two orbit improvements (Fig. 1, pink blocks). The GPS satellite manoeuvres are detected (± 10 min) through the analysing navigation messages. High efficiency is reached using a network clustering for parallel runs (Fig. 1, black boxes), which are implemented for all processing steps. The white boxes in figures finalizes individual parallel steps and red boxes represent preliminary daily solutions for specific parameter estimations. The initial clusters are defined for continents, but based on real data they

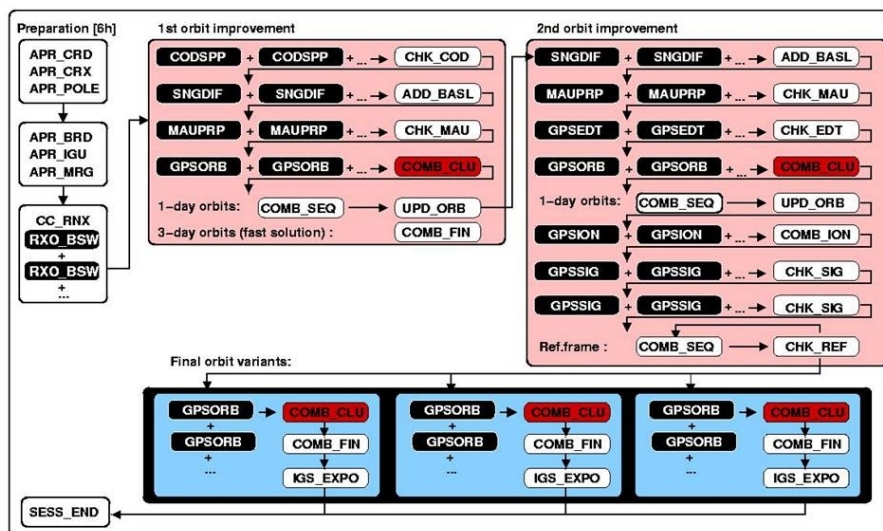

Figure 1: GOP processing scheme based on 6-hour data batch and long-arc combination

are flexibly reconfigured. According to the processing load in various steps, the clusters are setup to small (5–10 sites) or medium (20–30 sites) size. All parameters, which are out of interest, are pre-eliminated or fixed from previous iterations whenever possible. All steps of daily results are based on a combination of four 6-hour NEQs, while the final product is combined over 2-days (eight 6-hour NEQs). More final variants can be run in parallel after the pre-processing steps (Fig. 1, blue boxes). The long-arc orbit modelling is based on the extended CODE model (Beutler et al., 1994) with periodical solar radiation parameters constrained according to Tab. 1. The stochastic parameters in radial, along-track and out-of-plane direction are estimated (and constrained, see Tab. 1) only for satellites in eclipse at epoch approximately in a mid of the interval. All satellites are always included in the processing, but in case of a modelling problem the observations from relevant satellite are down-weighted in 6-hour solution. The official GOP official product is filtered based on various internal information from the processing and exclusion of individual satellites or changing their accuracy code is finally performed. Various other checking procedures are incorporated within the processing system — e.g. single station rejection, datum definition robustness etc.

Table 1: RPR (D,Y,X) and stochastic parameter (R,A,O) constrains

Parameter	constrains	units
constant D/Y/X terms	unconstrained	m/s^2
periodic D/Y/X terms	1.0E-12 / 1.0E-10 / 1.0E-11	m/s^2
stochastic parameters (radial/along/cross)	1.E-7 / 1.E-7 / 1.E-9	m/s

3 Strategy improvements during 2005–2011

In first half of 2006 we completely revised our system (processing steps, modelling etc.), but still keeping 6-hour observations processing scheme as an efficient basis. This revision provided significant improvements in GOU solution and it is clearly visible in IGS comparison after a gap in GOP contribution (caused by the development due to a lack of hardware). Many small changes/improvements were done later on in order to fix bugs, to enhance an efficiency and robustness of the processing and to support easier maintenance. The list of significant changes is summarized in Tab. 2, while many others applied during the period of 2006–2011 are not specifically mentioned. The quality overview of the original (2005) and improved (2010) GOP ultra-rapid GPS product is given in Tab. 3. A specific processing extension concerning multi-GNSS support is described in Section 4.

4 GOP GLONASS ultra-rapid product

In 2009, GLONASS consisted of 20 active satellites and stand-alone GLONASS orbit determination solution was developed (Dousa, 2012). A revision of all processing steps of existing GOP solution was necessary to reach a maximum robustness of a stand-alone GLONASS solution, which finally resulted in improvements of GOP GPS official contribution to IGS. The GLONASS solution was implemented as an extension to the original GOP processing scheme (i.e. rigorously combining all observations). Some differences in individual steps of the processing between GLONASS and GPS exist (e.g. in ambiguity resolution for GPS only etc.), but these are handled automatically within individual scripts. A single option for switching between GPS, GLONASS or GNSS analysis allowed us to perform tests between these three solutions during two 60-day periods (Nov/Dec 2008 and May/June 2009) for the evaluation of products (Dousa, 2012). The results shown that the GPS orbit quality didn't decrease in combined solution, while GLONASS orbits were improved compared to the stand-alone GLONASS solution. The latter was due to many common parameters estimated mainly from GPS observations. The GLONASS orbits are still of $2\text{--}3 \times$ lower accurate than GPS in GOP solution. The main problem remains in modelling satellite orbits during eclipsing periods, which is demonstrated in Fig. 2. The estimated stochastic parameters are shown at the left plot (and represents eclipsing intervals), while the orbit quality is shown at the right plot. There were some changes in constraining of the stochastic pulses within the plotted time-span. However, the performance of estimated radial and along-track stochastic parameters seems to eliminate some remaining systematic errors in current model during eclipsing periods. Since September 2010 GOP contributes to the IGS unofficial combination of four GPS+GLONASS ultra-rapid orbit rigorous solutions.

Table 2: Significant changes during 2006–2011 (i.e. after the system revision)

Year:DoY	processing changes
2011:221	improved outliers checking and bad station handling
2011:106	switch from IGS05 to IGS08 reference frame and PCO+PCV model
2011:092	fixed long-term problem with G24 and G08 due to stochastic parameters setup close to the start of orbit integration
2011:052	reset stochastic parameters not estimated from 2011:043 (by mistake)
2011:039	fixed the problem with concatenated navigation files at GOP data centre
2010:354	switch from teqc data concatenation to Bernese internal concatenation
2010:338	fixed the problem with stochastic parameters at the beginning of short orbit arc (related to the processing batch)
2010:305	added tight constrained for stochastic pulses close to the end of long-arc orbits
2010:299	down-weighted GLONASS satellites in eclipse
2010:258	official switch from GPS-only contribution to multi-GNSS (GPS+GLONASS)
2010:128	start of GPS+GLONASS solution (in parallel to official GPS one)
2009:269	solution corrupted due to the CDDIS data centre problem
2009:244	prolonged procedure of identifying processing start to get more (delayed) stations
2009:229	solution problem due to incorrect SATELLITE.I05 during decommissioned G25 and setting new G05 satellites
2009:204	DATUM definition based on 3 days instead of a single day
2009:141	three-day combination decreased to two days with modified arc-splitting procedure
2008:269	switch to gfortran compiler
2008:242	fixed problem with ambiguity resolution when reference satellite in manoeuvre
2008:078	down-weighted accuracy code for satellites temporarily marked as bad
2008:022	switch from LH98 to IFC7 compiler
2008:006	fixed incorrectly used I0B at one pre-processing step
2007:356	X-periodical RPR constrained changed from 1.0E-10 to 1.0E-11
2007:338	change setting up SP3 accuracy code based on prediction comparisons
2007:305	increased number of station > 90
2006:309	switch from IGB00 to IGS05 (igs05_1390.atx)
2006:264	new official solution based on the system revision

Table 3: Assessment of GOP ultra-rapid product quality between 2005–2011

Solution	orbits [cm]	polar-motion [PM] [mas]	PM rates [mas/day]	LOD [ns]
GOU (2005)	12/24	0.3/0.5	0.4/0.4	0.07/0.09
GOU (2011)	4/10	0.1/0.3	0.2/0.4	0.03/0.07

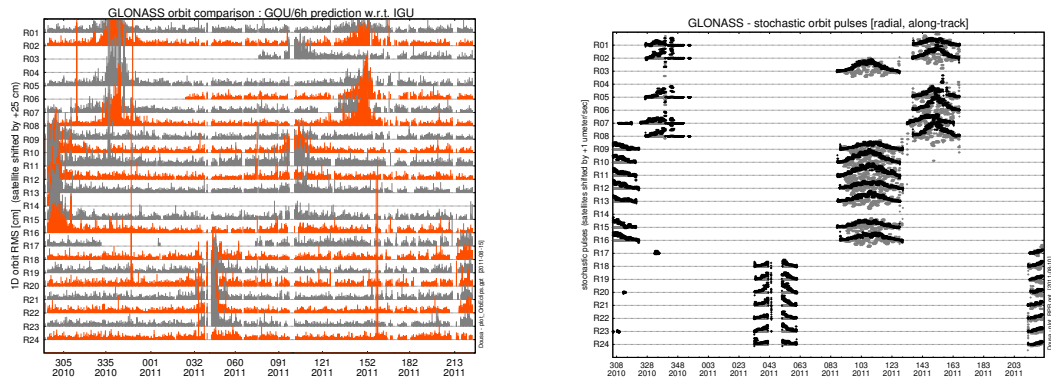

Figure 2: Quality of GLONASS orbits w.r.t. IGS finals (left) and estimated radial (grey) and along-track (black) stochastic pulses for eclipsing GLONASS satellites (right)

5 Products monitoring and user assesement

The ultra-rapid orbits are used in (near) real-time applications and thus its prediction part (3–9 hours) is the most important (Dousa, 2011). GOP provides on-line evaluation system for the orbit prediction performance. Fig.3 shows the results of time-series of monthly RMS orbit prediction errors for two satellites selected because of the different Block types. The effect of a half-year periodic degradation of the orbits is related to the satellite eclipsing periods. The bottom figures of Fig.3 show the dependence of the accuracy on prediction interval for eclipsing and non-eclipsing satellites. Many detailed figures are available at <http://www.pecny.cz> (GNSS, orbits), which include e.g. the monitoring of real-time IGS portions in such a way that are used in end-user real-time applications.

GOP is active in GNSS-meteorology (Dousa, 2010), which was one of the primary application of the IGS ultra-rapid orbits since 2000. The GOP has recently developed two new tropospheric solutions — global hourly and GPS+GLONASS products, both contributing to the EUMETNET EIG GPS Water Vapour Programme (<http://egvap.dmi.dk>). Thanks to significant improvements of IGS ultra-rapid orbits since 2000 in terms of quality and robustness, a GPS near real-time troposphere estimation is an easy task today. However, developing a global product consisting of long-baselines more sensitive to the quality of the orbits, the user solution requires a high robustness including identification of satellite/station rejection etc. Similar experience was gained at GOP when GLONASS stand-alone and multi-GNSS solution based on unofficial IGS GPS+GLONASS combination was implemented. As already mentioned GLONASS orbits are still about twice lower accurate than GPS orbits. One year multi-GNSS near real-time solution at GOP already proved that the IGS unofficial GPS+GLONASS ultra-rapid product can be operationally exploited for troposphere monitoring. Finally, stand-alone GPS and GLONASS derived ZTD comparison revealed a bias about 1–2 mm, which disappeared after switching to IGS08

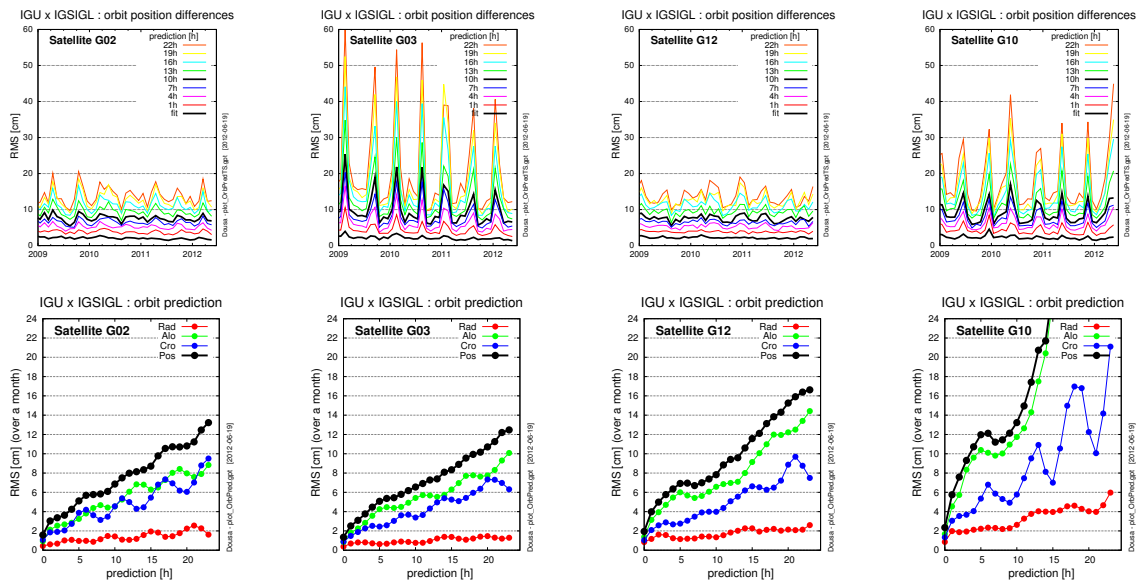

Figure 3: Plots show time-series of GPS satellite orbit quality (top) and the prediction of radial, along-track and cross-track monthly dependence on prediction (bottom). Two left plots show non-eclipsing and right eclipsing satellites. G02 and G12 are Block IIR, while G03 and G10 Block IIA satellites. Colors shows accuracy for fitted (0h) and predicted positions (1h, 4h, 7h, 10h, 13h, 16h, 19h, 22h) The orbits are compared to IGS finals

because of inconsistencies between GPS and GLONASS satellite antenna offsets.

References

Beutler, G., E. Brockmann, W. Gurtner, U. Hugentobler, L. Mervart, and M. Rothacher. Extended orbit modeling techniques at the CODE processing center of the International GPS Service for Geodynamics (IGS): Theory and initial results. *Manuscripta Geodaetica*, 19:367–386, April 1994.

Dach, R., U. Hugentobler, P. Fridez, and M. Meindl (eds). *Bernese GPS Software Version 5.0*. Astronomical Institute, University of Berne, Berne, Switzerland, 2007.

Dousa, J. Precise near real-time GNSS analyses at gop — precise orbit determination and water vapour monitoring. *Acta Geodetyn. Geomater.*, 7:1–11, 2010.

Dousa, J. The impact of errors in predicted gps orbits on zenith troposphere delay estimation. *GPS Solutions*, 13(3):229–239, 2011.

Dousa, J. Development of the GLONASS ultra-rapid orbit determination at Geodetic Observatory Pecny,. In S. Kenyon, M.C. Pacino, and U. Marti, editors, (*Geodesy of Planet Earth*), volume 136 of *International Association of Geodesy Symposia*, pages 1029–1036, 2012.

The CNES–CLS IGS Analysis Center Annual Report 2011

*S. Loyer¹, F. Perosanz², H. Capdeville¹, M. Pau¹,
F. Mercier², J.–C. Marty², L. Soudarin¹*

¹ Collecte Localisation Satellites, 31520 Ramonville Saint Agne, France

² Centre National d’Etudes Spatiales, 31400 Toulouse, France

1 Introduction

CNES (Centre National d’Etudes Spatiales) and CLS (Collecte Localisation Satellites) joined their efforts to officially become an IGS Analysis Center (AC) the 20th of May 2010 after more than two years of an intensive evaluation phase (Cf. IGSmal #6155). As a consequence, this is our first contribution to an IGS technical report. The main motivations to become an IGS AC were to evaluate the performance of the GINS/Dynamo software package developed by CNES and GRGS (Groupe de Recherche de Géodésie Spatiale), to participate in the different IGS working groups and to contribute to the discussions on processing strategy, standards definition, etc. The CNES–CLS IGS Analysis Center products are called GRG and are generated using an innovative strategy to fix integer GPS phase observation ambiguities at the zero–difference level (Laurichesse and Mercier, 2007). A description of how this algorithm has been implemented into GINS/Dynamo is given in Loyer et al. (2012). More information on our AC activity can also be found at: www.igsac-cnes.cls.fr.

2 Routine products delivery

Today our contribution is limited to “final” GPS and GLONASS products. We compute weekly normal equations containing all the necessary parameters like station coordinates and Earth Orientation Parameters (EOP). In practice the normal equations are computed on a daily basis and are combined into a weekly equation that is inverted using the Dynamo software. The complete covariance matrix and solution is delivered in SINEX format to the IGS. The final orbit solution is obtained after a final run using 300 s sampling data and the weekly station coordinates and EOP solution from the previous step. This ensures

Table 1: List of GRG final products delivered weekly

grgwww7.ERP	ERP (pole, UT1–UTC) solution for 1 week in IGS IERS ERP format
grgwww7.SUM	Analysis summary for the week
grgwww7.SNX	Weekly Solutions for EOP and Stations coordinates in SINEX format with complete information (covariance and used constrains)
grgwwwn.SP3	Daily GNSS ephemeris/clock at 15–min intervals (GPS + GLONASS since week 1617, GPS–only before)
grgwwwn.CLK	Daily GPS ephemeris/clock at 30–sec intervals (5 min sampling before week 1686)
grgwww7.WSB	Weekly updated GPS wide–lane satellite biases (available at ftp://ftpsedr.cls.fr/pub/igsac)

that the delivered solutions (orbits and station coordinates) are expressed in the same reference frame. In order to produce GPS 30 s sampling clk files, we have implemented an effective method in which the final orbits and the other associated parameters are fixed. Only the 30 s clock parameters are solved for, epoch by epoch, by a “densification” of the observations. Table 1 gives the list of the GRG products delivered to the IGS.

3 Processing strategy

Software packages

GINNS is a multi–satellite software in which all the modern geodetic measurements can be processed together. Initially dedicated to gravity field computations, the GINS software has been used since the end of the 90ties to process GPS signals. The software has been updated several times to handle the increasing size of the IGS station network and to improve GNSS orbit and clock computation. The model parameters are processed by least squares adjustment of the linearized observation equations. The numerous clock parameters are reduced epoch by epoch (i.e. pre–eliminated from the normal equation before inversion). If necessary, the normal equation matrix can be stored for later use. The Dynamo software package provides all the functions to handle the individual normal equations (summation, reduction, and linear system resolution). Since 2007 and the beginning of our participation in the IGS we made intensive efforts to process GNSS data in an automated mode and on a weekly basis. Many other tools or software are included today in our processing scheme.

Network

Our site selection is a compromise between processing capabilities and product quality. Following IGS and ITRF recommendations we include as many as possible sites co–located with other systems or techniques. Our current network contains around 70 GPS–only receivers and 70 hybrid GPS–GLONASS receivers.

Models and Parameters

Like any AC we have the dual and challenging goal of:

- improving the accuracy and precision of the products
- follow the international conventions and improve the consistency of the products between the ACs

This needs a careful care to models updating and parameterization strategy.

The present status of our processing characteristics is detailed at: <http://igs.cb.jpl.nasa.gov/igs/cb/center/analysis/grg.acn>.

Finally Loyer et al. (2011) have compared AC's solar radiation pressure models thanks to an innovative approach based on satellite acceleration recovering from sp3 files.

Table 2: Processing strategy history

GPS week	Synthetic description of the main changes between the successive versions of the GRG processing
1478	Initial solutions: <ul style="list-style-type: none"> • Network of 80 stations • 15 min clocks estimates • complete B&Wings modeling • real valued ambiguities.
1497	One stochastic pulse during eclipse periods is added for the eclipsing satellites
1515	Beginning of production of 30second clocks (only 5 min clocks are delivered to the IGS)
1521	Network extension (up to 115 stations)
1555	Integer ambiguities fixing at the zero-difference level
1580	Adoption of the simplified dynamic B&W modeling The SINEX solution includes now the complete constraint matrix used. This allows the IGS Reference Frame Coordinator to combine our solution in a rigorous way.
1582	GRG solution official contributor to GPS IGS final products (IGSMAIL#6155)
1602	Network extension (up to 140 stations) Tropospheric mapping function GMF
1617	GRG solution official contributor to GLONASS IGS final products (IGSMAIL#6155)
1632	Switch to igs08.atx center of phase offsets (see IGSMAIL#6354)
1674	Tropospheric gradients estimation GPS satellite attitude (Kouba's 2009 model)

4 Processing characteristics history

As we recently joined the ACs of the IGS, we recall in table 2 the full story of the main changes in our processing strategy. The corresponding impact on our products has been evaluated and some examples are given hereafter.

Orbit solution

Figure 1 shows the WRMS residuals of all the IGS Analysis Centers (ACs) relatively to the IGS combined orbits (<http://acc.igs.org>). The main changes impacting the comparison with the IGS final orbits are the ambiguity fixing used since October 25, 2009 (GPS week 1555) and the dynamical modeling since April 18, 2010 (GPS week 1580). Figure 2 compares the orbit overlaps computed every day between two successive GRG solutions without and with ambiguity fixing. The tangential and cross-track RMS decrease

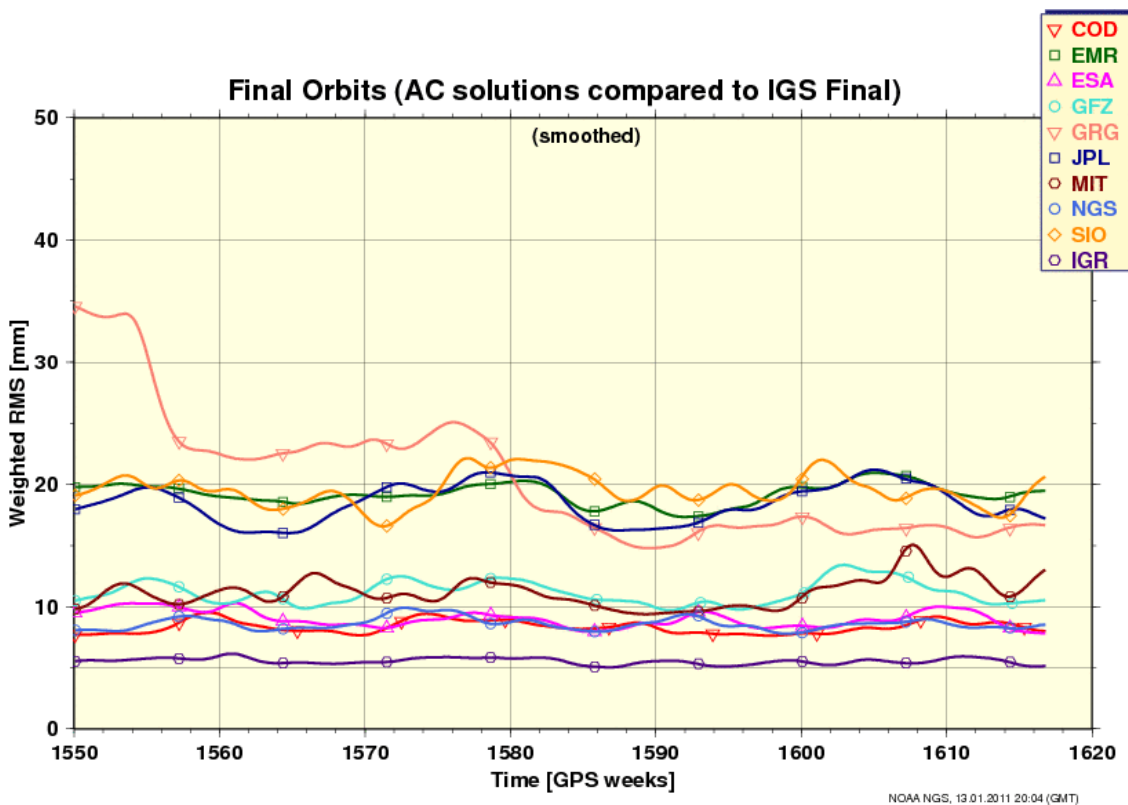

Figure 1: Smoothed weighted RMS of the individual IGS analysis center solutions vs. the IGS final orbits between GPS week 1550 (September 20, 2009) and GPS week 1618 (January 9, 2011). From Ray et al., <http://acc.igs.org>

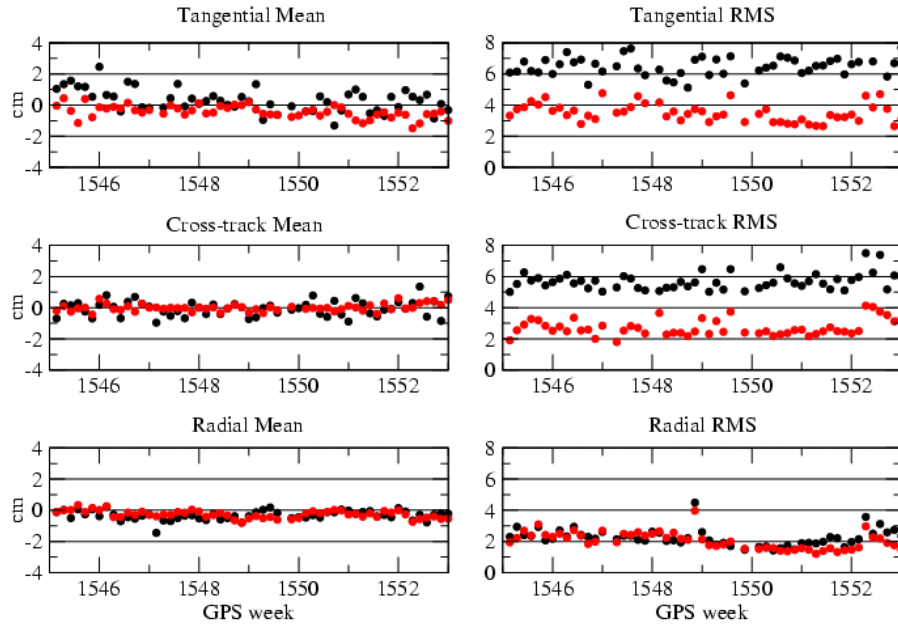

Figure 2: Global un-weighted mean (left) and RMS (right) overlaps between two daily realizations of our GPS orbits. Floating solution (black) compared to ambiguity fixed solution (red) from GPS week 1545 (August 16, 2009) to GPS week 1553 (October 17, 2009).

from 6 to 3 cm while the changes in the radial RMS and the mean values of the overlaps are not significant. After changing the satellite SRP modeling using only the solar panels in our Box and Wing representation of the satellite (instead of a more detailed description of the surface we used before), we obtained better agreement with the IGS orbits.

Stations coordinates solution

The inter-comparison of the different Analysis Center solutions provides a weekly evaluation of our global frame coordinate estimates (Rebischung and Garayt, 2012). The global RMS residuals in the up direction between our solution and the IGS one improved from 8.5 to 5.5 mm when the ambiguity fixing was used in our solution (see figure 3). The impact on the horizontal direction is below the millimetre level. The RMS of the GRG solution residuals agree today at a level of 3 mm in the horizontal components and 6 mm in the vertical component. Due to different processing and modelling used by the ACs, systematic millimetre distortions remain. Part of these differences could be explained by the lack of tropospheric gradient estimation in our solution (see Bar-Sever et al., 1998). A gradient mapping function like the one described in Chen and Herring (1997) has been already implemented in the latest GINS version. Tropospheric gradient corrections as well as the GPS satellite attitude model recommended by Kouba (2008) are being considered in our solutions since week 1674.

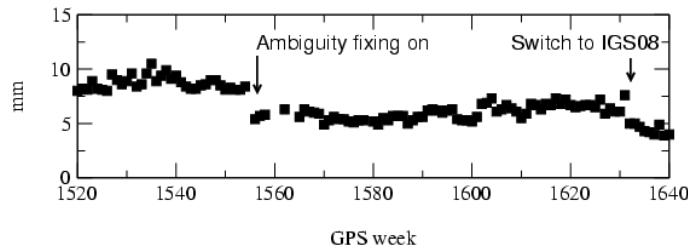

Figure 3: Global RMS residuals (up component) between our weekly network solution and the IGS weekly combined solution. From February 22, 2009 (GPS week 1520) to June 6, 2011 (GPS week 1640).

5 WSB and integer clocks products

The zero-difference ambiguity fixing method implemented into GINS requires a specific additional product we call WSB (“Wide-lane satellite Biases”) and provide to the GPS clock solutions a specific property.

WSB

In order to recover the integer nature of (un-differenced) phase ambiguities, un-calibrated phase delays at both the satellite and receiver level must be identified. Laurichesse and Mercier (2007) have demonstrated that the wide-lane combination of the satellite phase biases could be observed from a global network of stations. The determination of these “Wide-lane satellite Biases” is now part of our AC activity. A series of daily values covering 2000 to 2011 has been computed (figure 4). WSB seems very stable in time especially for recent block IIR and IIR-M satellites. The main variations (jumps) coincide with known events or on-board maintenance operations listed in GPS Notice Advisory to Navstar Users (NANU) delivered by U.S. Naval Observatory (USNO). The SVN 24 (PRN 24) satellite exhibits unusually large variations reaching few WL cycles between 2002 and 2006. The operational values used for our products are updated each week and available on our web site at: <ftp://ftpsedr.cls.fr/pub/igsac/grgwww7.wsb>.

Integer phase clocks

The satellite (phase) clock products derived from the integer zero-difference processing of GPS phase observations have a unique property: two independent solutions differ by an arbitrary value common to all satellites plus an integer number of Narrow-Lane cycles. This can be checked by comparing two successive clock solutions obtained from the processing of our overlapping arcs (30 hour sliding window centred on each day). This property is illustrated in figure 5 which represents the satellite clock solutions overlap (one

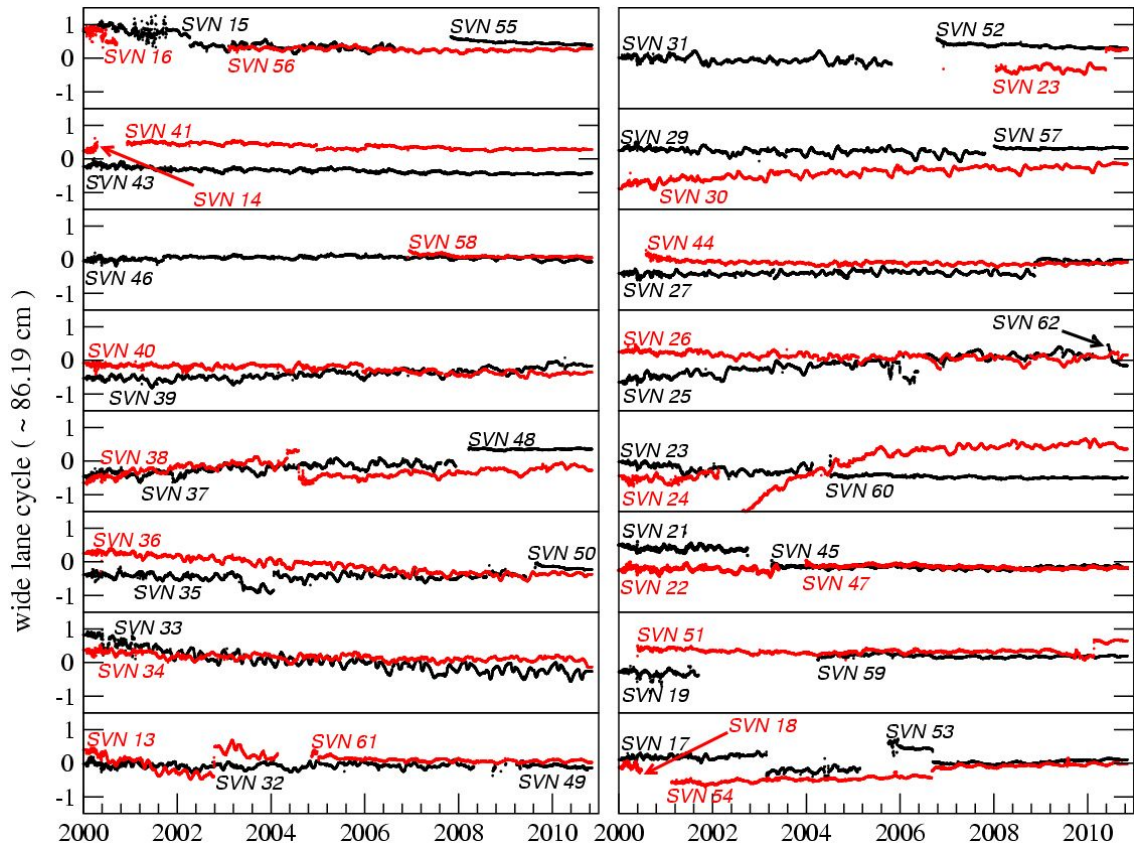

Figure 4: Observed GPS WSB between year 2000 and year 2010. One curve per Satellite Vehicle Number (SVN) is shown.

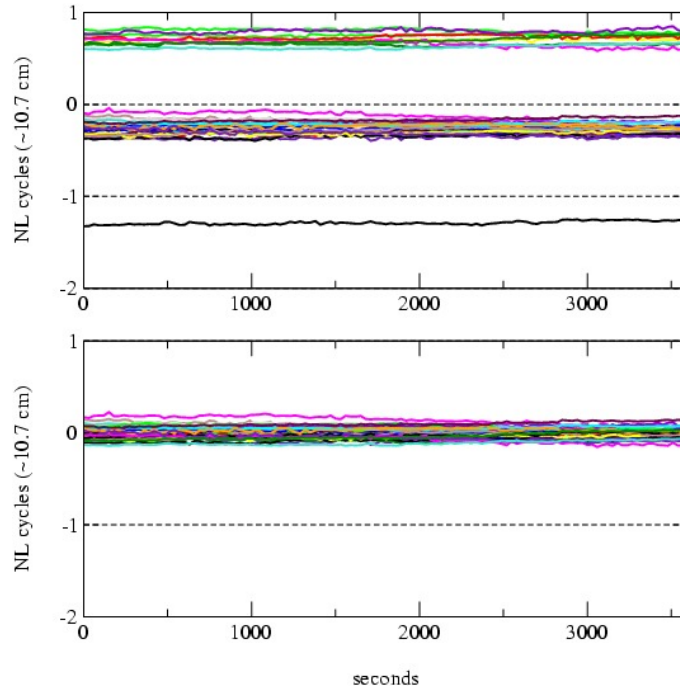

Figure 5: Example of the overlap differences between satellite clock estimates of day $n+1$ (March 8, 2011) and day n (one curve per satellite). Before correction (top) and after corrections (bottom).

colour per satellite) before correction (top plot) and after applying a common shift plus a ± 1 narrow-lane cycle bias to dedicated sets (bottom plot). In other words, a continuous satellite (phase) clock solution could be provided to the users. Possible applications are the improvement of kinematic point positioning of single receivers (Lescarmontier, 2012) or GPS-based continuous time transfer over long time spans (Delporte et al., 2008; Petit et al., 2011).

References

- Bar-Sever, Y. E., P. M. Kroger, and J. A. Borjesson. Estimating horizontal gradients of tropospheric path delay with a single GPS receiver. *J Geophys Res* 103(B3):5019–5035, 1998. doi: 10.1029/97JB03534
- Chen, G. and T. A. Herring. Effects of atmospheric azimuthal asymmetry on the analysis of space geodetic data. *J Geophys Res*, 102(B9):20489–20502, 1997. doi: 10.1029/97JB01739.

- Delporte, J., F. Mercier, D. Laurichesse and O. Galy. GPS Carrier–Phase Time Transfer Using Single–Difference Integer Ambiguity Resolution. *Int J Navig and Obs.*, 2008. doi: 10.1155/2008/273785.
- Kouba, J. A simplified yaw–attitude model for eclipsing GPS satellites. *GPS solutions*, 13:1–12, 2008. doi: 10.1007/s10291-008-0092-1.
- Laurichesse, D. and F. Mercier. Integer ambiguity resolution on undifferenced GPS phase measurements and its application to PPP. *ION GNSS 2007*, 20th International Technical Meeting of the Satellite Division, 25–28 September 2007, Fort Worth, TX, pp 839–84813, 2007.
- Laurichesse, D., F. Mercier, J.P. Berthias, P. Broca and L. Cerri. Integer Ambiguity Resolution on Undifferenced GPS Phase Measurements and its Application to PPP and Satellite Precise Orbit Determination. *Navig J Inst of Navig*, ISSN: 00281522, 56(2): 135–149, 2009.
- Lescarmonnier, L., B. Legresy, R. Coleman, F. Perosanz, C. Mayet and L. Testut. Vibrations of the Mertz glacier ice tongue. *J Glaciolog*, in press, 2012. doi: 10.3189/2012JoG11J089.
- Loyer, S., F. Mercier, F. Perosanz and H. Capdeville. Comparison of different radiation pressure models for GNSS orbit determination. , presentation at the *European Geosciences Union General Assembly*, Vienna, Austria, 2011. http://acc.igs.org/orbits/srp-models_cnes_egu11.pdf.
- Loyer, S., F. Perosanz, F. Mercier, H. Capdeville and J.–C. Marty. Zero–difference GPS ambiguity resolution at CNES–CLS IGS Analysis Center. *Journal of Geodesy*, published on line: 03 April 2012. doi: 10.1007/s00190-012-0559-2
- Marty, J. C., S. Loyer, F. Perosanz, F. Mercier, G. Bracher, B. Legresy, L. Portier, H. Capdeville, F. Fund, J.M. Lemoine and R. Biancale. GINS: the CNES/GRGS GNSS scientific software. *3rd International Colloquium Scientific and Fundamental Aspects of the Galileo Programme*, ESA Proceedings WPP326, 31 August–2 September 2011, Copenhagen, Denmark.
- Petit, G., A. Harmegnies, F. Mercier, F. Perosanz and S. Loyer. The time stability of PPP links for TAI. Proc. *Joint conference FCS and EFTF 2011*. doi: 0.1109/FCS.2011.5977299
- Rebischung, P. and B. Garayt Recent results from the IGS terrestrial frame combinations. *IAG Symp REFAG2010*, Marne–La–Vallée, Z. Altamimi and X. Collilieux (Eds.), in press, 2012.

JPL IGS Analysis Center Report, 2005–2012

*S. Desai, W. Bertiger, B. Haines, D. Kuang,
C. Selle, A. Sibois, A. Sibthorpe, and J. Weiss*

Jet Propulsion Laboratory
California Institute of Technology
4800 Oak Grove Drive, M/S 238–600
Pasadena, CA 91001, U.S.A.
e-mail: shailen.desai@jpl.nasa.gov
phone: +1 – 818 – 354 – 6102

1 Introduction

The Jet Propulsion Laboratory (JPL) continues to serve as an Analysis Center (AC) for the International GNSS Service (IGS). We contribute orbit and clock solutions for the GPS satellites, position, clock and troposphere solutions for the ground stations used to determine the satellite orbit and clock states, and estimates of Earth rotation parameters (length-of-day, polar motion, and polar motion rates). This report summarizes the evolution of the JPL’s processing approach since 2005, our contributions to the IGS reprocessing campaigns, some IGS-related activities, and plans for future work.

The JPL AC continues to utilize the GIPSY/OASIS software package to generate our contributions to the IGS. Table 1 summarizes our IGS Rapid and Final products. We also contributed “Final” products to the first IGS reprocessing campaign, and will do so for

Table 1: JPL AC Contributions to IGS Rapid and Final Products.

Product	Description	Rapid/Final
jplWWWWd.sp3	GPS orbits and clocks	Rapid & Final
jplWWWWd.clk	GPS and station clocks	Rapid & Final
jplWWWWd.tro	Tropospheric estimates	Rapid & Final
jplWWWWd.erp	Earth rotation parameters	Rapid(d=0–6), Final(d=7)
jplWWWWd.yaw	GPS yaw rate estimates	Rapid & Final
jplWWWW7.snx	Weekly SINEX file	Final
jplWWWW7.sum	Weekly solution summary	Final

Table 2: Evolution of Processing Standards at the JPL IGS AC Since 2005.

Date	Description
Aug. 26, 2007	Adopt IGS05 antenna calibrations and reference frame.
Nov. 16, 2008	Receiver elevation angle cutoff changed from 15 to 7 degrees. Adopt GMF troposphere mapping function (Boehm et al., 2006). Adopt GPT dry troposphere model (Boehm et al., 2007). Adopt hardisp ocean tide loading function. (Petit and Luzum, 2010)
Jul. 18, 2011	Adopt IGS08 antenna calibrations and reference frame. Adopt IERS 2010 standards. (Petit and Luzum, 2010) Adopt GSPM10 solar radiation pressure model (Sibthorpe et al., 2010).

the next reprocessing campaign. All of our contributions are based upon daily solutions centered at noon and spanning 30–hours. Each of our daily solutions is determined independently of neighboring solutions, namely without applying any constraints between solutions.

2 Changes to Processing Standards and Software

Since 2005 we have applied numerous changes to our processing standards, models, and software. A summary of the most significant changes to our processing approach is provided in Table 2. The most relevant change was the adoption of the IGS absolute calibrations in August 2007. A complete description of our current processing approach can be found at: <http://igs.cb.jpl.nasa.gov/igs.cb/center/analysis/jpl.acn>. In addition, we have modernized the data manipulation, quality control, and product generation software surrounding GIPSY/OASIS, first in August 2007, and again in November 2008. We continue to favor using our GPS solar radiation pressure models instead of the DYB–based strategies that are commonly used by other IGS analysis centers. This choice is based upon an extensive evaluation of various internal and external metrics after testing both approaches with the GIPSY/OASIS software (Sibthorpe et al., 2011).

3 Contributions to IGS Reprocessing Campaigns

The JPL IGS AC submitted the usual suite of “Final” products, as shown in Table 1, to the first IGS reprocessing campaign. In this reanalysis of historical data we adopted the IGS05–based absolute antenna calibrations. The JPL orbit and clock products from this IGS05–based campaign were used in the IGS combination. However, due to schedule limitations our SINEX file contributions were not used in the IGS contribution to the ITRF08 reference frame. We will contribute a similar suite of products to the next IGS

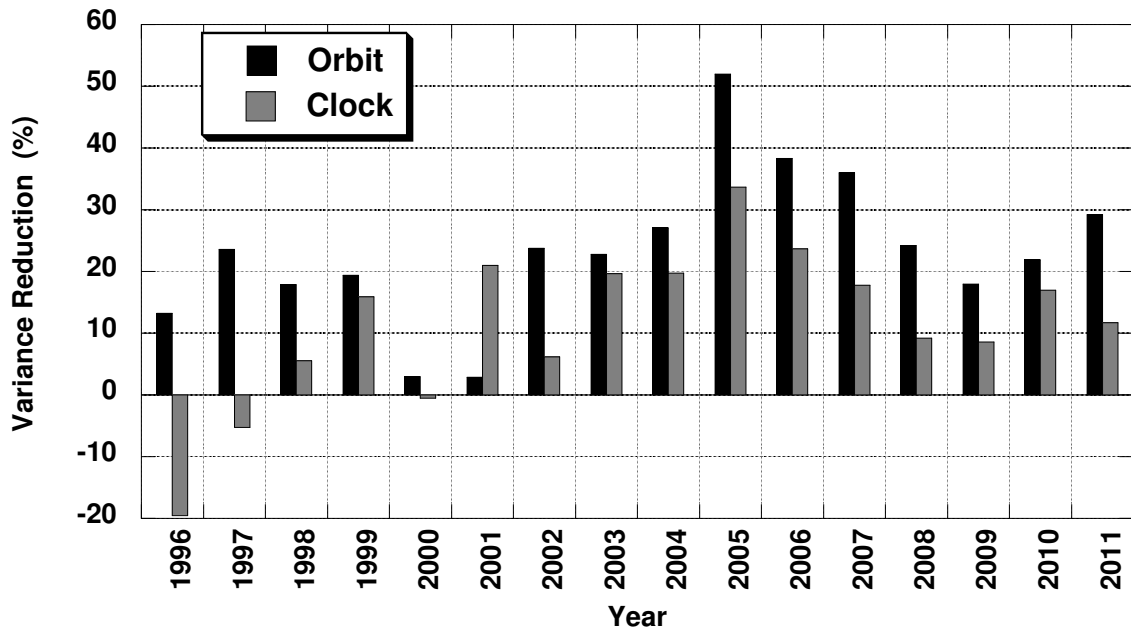

Figure 1: Variance reduction in orbit and clock precision of JPL’s first IGS08–based reanalysis of historical GPS data relative to our IGS05–based reanalysis. Precision is measured through the root–mean–square (RMS) of differences between neighboring daily 30–hour solutions during the overlapping 6–hour period. The average orbit and clock variance reduction for 1996–2011 is 25% and 12%, respectively.

reprocessing campaign, which is expected to be completed in the 2012–2013 time frame. In addition to the suite of “Final” products listed in Table 1 we will also deliver daily SINEX files for the entire reprocessing period, and high–rate (30–second) clock products for 1996 onwards.

At this writing we have completed a first reanalysis of historical GPS data from 1996–present using the operational processing standards that we adopted on July 18, 2011 (see Table 2). Our tests indicate that adopting the IGS08 absolute antenna calibrations and JPL’s GSPM10 (Sibthorpe et al., 2010) solar radiation pressure model for the GPS constellation provided the most significant improvements to the overall accuracy from this IGS08–based reanalysis compared to our IGS05–based reanalysis. In particular, we have shown an average variance reduction of 25% and 12% in GPS satellite orbit and clock precision for 1996–2011, respectively (Desai et al., 2011).

As shown in Figure 1 the variance of the orbit and clock precision from our IGS05– to IGS08–based reanalysis improved by as much as 50% in some years. Furthermore, the number of GPS satellites included in these most recent solutions has increased by an average of 0.6 satellites per day, with some days including as many as 7 additional GPS satellites. Investigations are ongoing to understand the reduction in clock precision for

Table 3: Terrestrial static and kinematic station repeatability using JPL’s IGS05– and IGS08–based reprocessed orbit and clock products, including single receiver ambiguity resolved positioning. Results are based upon 9 stations selected for global coverage and with occupation histories of at least 12 years. Repeatability is with respect to velocity model for each station. Units are mm.

Product	Static Point Position			Kinematic Point Position		
	East	North	Up	East	North	Up
IGS05	3.5	2.4	7.5	11.0	10.0	20.8
IGS08(Not Resolved)	3.0	2.1	6.1	9.5	8.8	18.9
IGS05(Resolved)	2.0	2.0	5.8	6.3	7.2	16.9

1996 and 1997. High–rate (30–second) clock products, only in native GIPSY formats, were already generated in this first IGS08–based reanalysis. While products from this first IGS08–based reanalysis have not been delivered to the IGS, they are available at <ftp://sideshow.jpl.nasa.gov/pub/jpligsac> in IGS formats, and at ftp://sideshow.jpl.nasa.gov/pub/JPL_GPS_Products/Final in native GIPSY formats.

4 Additional Developments at the JPL AC

The JPL IGS AC also started to operationally generate Ultra–Rapid orbit and clock products for the GPS constellation in 2009 (Weiss et al., 2010). Our Ultra–Rapid products are generated with a latency of less than 2 hours and are updated hourly. The Ultra–Rapid orbit and clock products have 3–D RMS accuracies of 5 cm, compared to 3.5 and 2.5 cm for our Rapid and Final products, respectively. The Ultra–Rapid products are available in native GIPSY formats at ftp://sideshow.jpl.nasa.gov/pub/JPL_GPS_Products/Ultra-Rapid.

Since 2010, all three of JPL’s GPS product lines in native GIPSY formats (Ultra–Rapid, Rapid, and Final) include a product that easily enables single–receiver phase ambiguity resolved positioning when used with the GIPSY/OASIS software (Bertiger et al., 2010). This product is referred to as the “wide–lane phase bias”, or WLPB, file. The products from our first IGS08–based reanalysis, described in the previous section, also include this WLPB file so that single–receiver ambiguity resolved positioning is easily achieved for the entire period 1996–present. The WLPB file provides wide–lane and phase bias estimates for each continuous phase arc from the network solution that is used to generate the orbit and clock states of the GPS satellites. When performing single–receiver positioning with GIPSY/OASIS, the orbit and clock products for the GPS satellites are used as usual, but wide–lane and phase biases for the receiver are also determined, followed by phase ambiguity resolution using double differences with the wide–lane and phase bias estimates from the network solution.

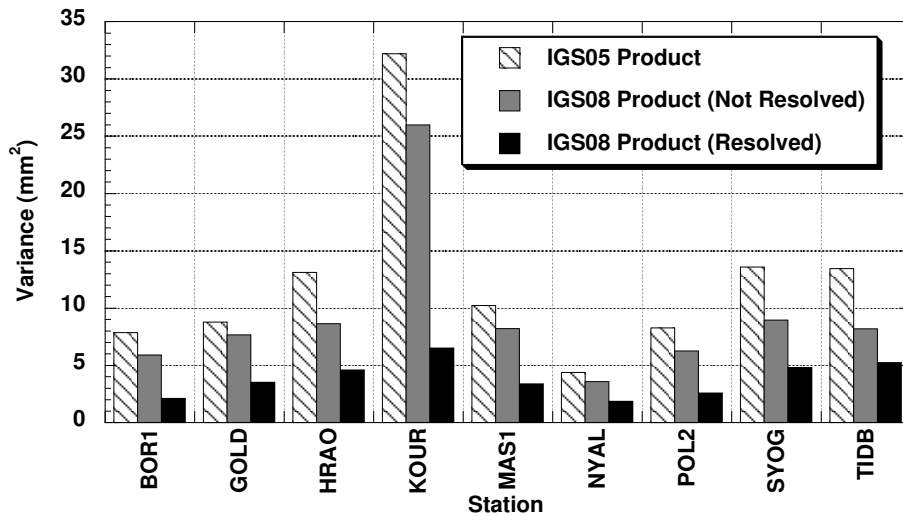

Figure 2: Impact of JPL’s orbit and clock product improvements (IGS05– to IGS08–based products), and single receiver ambiguity resolution (using WLPB product), on east component of station repeatability for 9 globally distributed stations with occupation histories of at least 12 years. Station repeatability is based upon daily static point positioning and with respect to velocity model for each station.

Table 3 summarizes the improvements to be gained in static and kinematic terrestrial positioning when transitioning from our IGS05– to IGS08–based orbit and clock products, and the subsequent improvements to be gained from performing single receiver phase ambiguity resolution with our IGS08–based products (Desai et al., 2011). These results are based upon 9 stations selected for global coverage and occupation histories of longer than 12 years. We observe variance reductions of 30–70% in station repeatability from using our most recent orbit and clock products and the single receiver ambiguity resolution capability.

Figure 2 illustrates, as an example, the improvements in the east component of station repeatability for the 9 stations used to generate the metrics in Table 3. The east component typically realizes the most significant improvements from ambiguity resolved point positioning.

5 Future Activities

We anticipate some additional changes to our processing approach before performing a second IGS08–based reanalysis in support of the IGS reprocessing campaign. For example, inclusion of second order ionosphere corrections, models for the S1/S2 atmospheric load deformation effects, and improved solar radiation pressure models are currently being tested or developed. Furthermore, work is also underway to include reprocessed products

for the period 1993–1995, including generation of the associated WLPB files to enable single receiver ambiguity resolution.

6 Acknowledgments

The work described in this report was performed at the Jet Propulsion Laboratory, California Institute of Technology under a contract with the National Aeronautics and Space Administration.

References

- Bertiger, W., S. Desai, B. Haines, N. Harvey, A. Moore, S. Owen, and J. Weiss. Single receiver phase ambiguity resolution with GPS data. *J. Geodesy*, 84(5):327–337, 2010. doi: 10.1007/s00190-010-0371-9
- Boehm, J., A. Niell, P. Tregoning, and H. Schuh. Global Mapping Function (GMF): A new empirical mapping function based on numerical weather model data, *Geophys. Res. Lett.*, 33, L07304, 2006. doi: 10.1029/2005GL025546
- Boehm, J., R. Heinkelmann, and H. Schuh. Short Note: A global model of pressure and temperature for geodetic applications. *J. Geodesy*, 81(10):679–683, 2007. doi: 10.1007/s00190-007-0135-3
- Desai, S.D., W. Bertiger, B. Haines, N. Harvey, M. Miller, C. Selle, A. Sibthorpe, and J.P. Weiss. Long-term evaluation of precise point positioning with single receiver phase ambiguity resolution using JPL’s GPS products. *EGU General Assembly*, Vienna, Austria, 2011.
- Pertit, G., and B. Luzum. IERS Conventions 2010. IERS Technical Note No. 36, 2010.
- Sibthorpe, A., J. Weiss, N. Harvey, D. Kuang, and Y. Bar-Sever. Empirical modeling of solar radiation pressure forces affecting GPS satellites. *AGU Fall Meeting*, San Francisco, CA, 2010.
- Sibthorpe, A., W. Bertiger, S.D. Desai, B. Haines, N. Harvey, and J.P. Weiss. An evaluation of solar radiation pressure strategies for the GPS constellations. *J. Geodesy*, 85(8):505–517, 2011. doi: doi:10.1007/s00190-011-0450-6
- Weiss, J.P., W. Bertiger, S.D. Desai, B. J. Haines, and C.M. Lane. Near real time GPS orbit determination: Strategies, performance, and applications to OSTM/Jason-2. *Adv. Astronaut. Sci.*, 137: 439–452, 2010.

MIT IGS Analysis Center Report for 2011

T. A. Herring, R. W. King

Room 54–820A, MIT
77 Massachusetts Avenue, Cambridge, MA 02139
e-mail: tah@mit.edu; phone: +1 617 253 5941

1 Introduction

In this report we review the products generated by the MIT Analysis Center that are submitted to the IGS and made available through the MIT ftp site. We examine some aspects of the MIT analysis focusing on network generation, treatment of solar radiation parameters, and the method used to generate the MIT 30-second clock products. We also show results for position repeatability and satellite antenna phase center offsets and nadir dependence of the phase pattern.

2 MIT products

MIT generates weekly submissions to the IGS final orbit and clock products. Our submissions consist of (where WWWW is GPS week and [0–6] are the values between 0 and 6): `mit<WWW>7.sum` which is a summary file consisting of site statistics (phase and position root-mean-square (RMS) scatters, RMS scatter of clock fits to linear trends of the reference clocks for each day of the week, RMS scatters of the orbit overlaps (3.75 hrs on both sides of each orbit) and Earth orientation parameters (EOP) estimates in IERS standard format.

mit<WWW>7.erp.Z Earth rotation parameters for 9-days IERS format

mit<WWW>[0–6].sp3.Z Daily GPS satellite orbits tabulated at 15 minute intervals with satellite clock estimates.

mit<WWW>[0–6].clk.Z Daily GPS satellite clocks tabulated at 30-second intervals for the satellites and reference ground station. Other ground station clocks are tabulated at 15 minute intervals.

mit<WWW>7.snx.Z Weekly coordinate and EOP SINEX file with minimum constraints applied to orient the solution to the IGS08 reference frame.

We also make available through `ftp://everest.mit.edu` binary global files for daily and weekly solutions, radiation parameter constraints, and position time series. GAMIT/GLOBK users can directly use these products. The global position and orbit files have estimates of the satellite phase centers, loosely constrained, and are a resource for analyzing the estimates of the these offsets. The estimates of the phase centers should be tightly constrained if consistency with the IGS models is needed. The files containing process noise values for solar radiation parameters can be used to apply similar orbital constraints to those used in the MIT analysis (see discussion below).

3 Analysis methods

The MIT analysis uses a global network made up of 6 separate networks, with each constructed to form as global a network as possible. Each network is made up of 50 stations of which two sites per network are common to the other 5 networks. No sites are used more than twice in the networks. The networks are formed simultaneously, with sites being added to each network sequentially so as to ensure that all networks have good southern hemisphere coverage. The algorithm starts with a base group of four stations in each of the networks although there is no requirement that data be available from these stations on a specific day. Sites are then added from the list of core sites and available stations. The list of available stations is determined from the FTP directories of the IGS and other archives. Sites are added at each iteration such that the added site has the largest possible distance from the other sites in the network. Initially, six networks of 40 unique sites are formed, and then pairs of these sites are added to the other networks to form the ties between the networks. The core list of sites includes the ITRF2008 reference stations, hydrogen maser timing stations, and other stations of interest. This core list currently consists of 374 stations. On any given day, many of these stations are not available and so the networks we form use all of the available stations in the core list and stations chosen from the available sites. An example of the combined network generated for the last day of 2011 is shown in Figure 1.

3.1 Solar radiation parameter estimation.

The MIT analysis initially uses the full 15 parameter Berne orbit model; 6 initial conditions, 3 solar radiation constant terms in the direct, Y-axis, and the orthogonal B axis directions, and 3 pairs of the sine and cosine once-per-revolution (OPR) terms directed along the same axes. The parameters are expressed as scale factors on the direct radiation force. This model, in general, is poorly constrained with 24-hour orbit arcs and when all 6 OPR terms are estimated the center of mass location and the rates of change of the

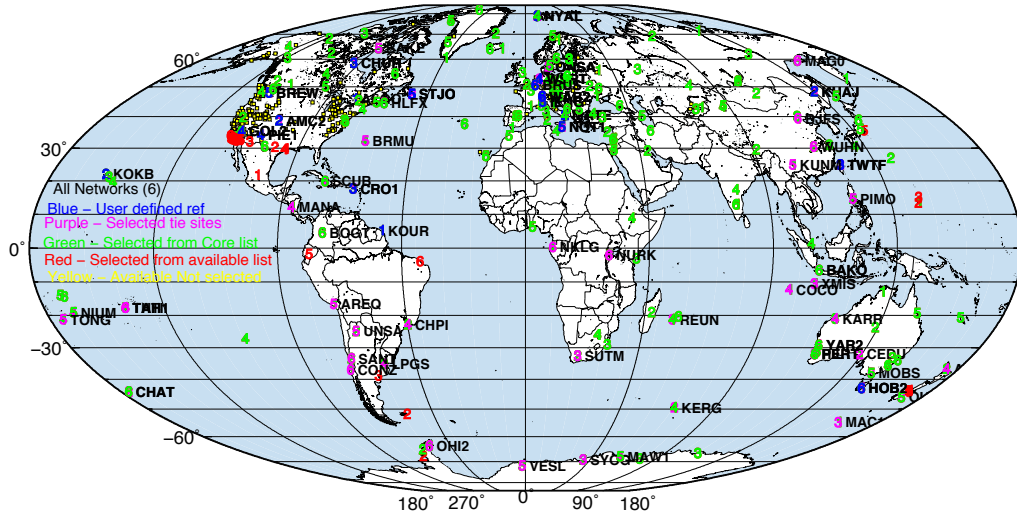

Figure 1: Example of the MIT global network on day 365 of 2011. The names the sites in black are common between 2 networks and serve to tie the networks together. The numbers shown in different colors give the network number for the station. The green and purple stations are from our core list of sites while the red numbered stations come from the available lists. The yellow dots show stations that are available but are not used in our analyses.

Earth orientation parameters (EOP) are poorly determined. In our weekly analyses, we examine solutions with all of the OPR terms estimated, and based on the statistics of the estimates determine, which ones should be retained in the final analysis. We always estimate that the B-axis OPR terms. The estimation of the direct and Y-axis terms is based mainly on the significance of the estimates for the week. We also use an orbital overlap criteria set such that if the RMS scatters of the orbit overlaps for specific satellites are greater than 30 cm, all of the OPR terms for those satellites are estimated. If the orbit overlaps are greater than 10 cm (but < 30 cm), then the Y-axis OPR terms are retained. With recent GPS data, the orbital overlap criterion is generally not used (i.e., orbit overlaps have < 10 cm RMS). For most weeks only 1 or 2 satellites require more than just the B-axis OPR terms. Once the specific representation is set, we use daily estimates of the OPR terms to set the random walk process noise value for each of the terms. If the chi-squared per degree of freedom of the estimates over the week is less than 1 then zero process noise is assigned and a constant value for the specific term is estimated for the week. When the chi-squared per degree of freedom is greater than 1, the process noise value is set such that a random walk would have the same standard deviation over a week as the observed scatter. The values of the ORP process noise values are available from the `everest.mit.edu` ftp site in the MIT_SRP folder. One set of parameters is used from each week unless there is a specific issue that needs to be manually accounted for. Manual interventions are only needed in the 1990's GPS data analyses.

3.2 Clock estimation

The MIT phase data analysis uses a double difference strategy. To generate our clock solutions we perform a separate analysis to determine the clocks after the weekly run is completed. In this analysis we take advantage of the fact that if a weighted least squares (WLS) solution is repeated with some of the parameters fixed to their WLS estimates then the other parameter estimates will retain their values from the original solution (the standard deviation of the estimates will be affected but in the case of clock solutions we are not using this information). To generate the clock estimates, we run an analysis with the orbits, EOPs, and station positions tightly constrained to their estimates from the weekly combination, and use a direct one-way clock estimates to generate the clock values. The apriori clock model, offsets and linear trends, is based on fitting the broadcast ephemeris clocks. The clock solution uses a smaller network than the original analysis. We choose the sites for this 120-station network (3-networks of 40 stations) based on the quality of the clock estimates in the original full run. The results from the three sub-networks are aligned and averaged. The clock estimates are generated at a 30-second rate and decimated to a 15-minute rate for all ground sites except the reference site. The reference site and satellites are all reported at a 30-second rate. The alignment of the clocks is an ensemble average over the sites with smallest RMS scatters about linear trends and the lowest RMS scatter site is chosen as the reference site. The RMS fit of these clocks is usually less than 30 ps (10 mm equivalent distance).

3.3 Position estimate quality

In Table 1 we give the statistics of the position estimates from the MIT analyses. We give the RMS scatters about the trend through the data for the periods from 2000 to 2012 and 2010 to 2012. The RMS scatters of both the weekly and daily solutions are below 2 mm for the horizontal components and 6 mm for the vertical components. Recent results are somewhat better than the longer-term results. The effects of correlation can be seen

Table 1: Median weighted RMS (WRMS) scatter of MIT position estimates for the periods 2000–2012 and 2010–2012. RMS scatters are computed from daily and weekly solutions. Due to temporal correlations the weekly solution scatter is only 70% smaller than the daily solution scatter compared to the 38% reduction expected for white noise. The final row is the average median scatter of the daily estimates within each week reported in the MIT summary files.

Analysis	North (mm)	East (mm)	Height (mm)	# stations
Daily 2000–2012	1.7	1.8	5.6	814
Daily 2010–2012	1.6	1.6	5.3	467
Weekly 2000–2012	1.2	1.3	4.0	812
Weekly 2010–2012	1.1	1.1	3.6	463
Daily in Week 2010+	1.2	1.2	3.9	259

in the table because the scatter from the weekly averages is not reduced by the amount expected for a white noise process. Also the daily values within one week have the same RMS scatter as weekly solutions computed over longer periods. The similarity all the RMS scatters in the east and north components indicates that ambiguity resolution on these global networks is largely successful. Statistics on the percentage of ambiguities resolved generally ranges between 90 to 95% for narrow lane ambiguities, and a higher percentage for wide lanes, which are based on the Melbourne–Wubben wide lane expression.

4 Ancillary analyses

In our routine analyses we also estimate positions of the satellite phase centers. For the products that we submit to the IGS, including SINEX file, the phase center offsets are tightly constrained to their values given in the ANTEX file. In Table 2, we give the mean values of the adjustments to the XYZ positions of the satellite phase center locations since the adoption of the IGS08 system (week 1632; 2011–04–17). Up to 55 weekly estimates are available since this change. Analysis of the temporal behavior of the offsets show there are systematic variations with time and in the X and Y components suggest that there are yaw modeling errors that are being absorbed into the phase center position estimates. We are still analyzing results. In our recent analyses, we have started to save the average values of the phase residuals as a function of elevation angle at individual stations and as a function of nadir angle for satellites. In Figure 2, we show the RMS scatter of the mean values, as a function of nadir angle, of these residuals for each of the satellites. PRNs 16 and 20 have the largest RMS and the values of the average residuals as a function on nadir angle for PRN 16 are shown in figure 3. The satellites with the lowest RMS scatters show very little systematic trend with the mean residuals lying within a mm of zero. The phase center variations seen at some the ground stations can be large and systematic. GPS site FAIR has very large systematic residuals with a deviation of nearly -10 mm at the highest elevation angle (80 deg). These large average residuals may explain the low quality of the survey tie at this site. The recent removal the radome at the site had only a small impact on the average residuals.

Table 2: Mean values of the adjustments to the IGS08 phase center locations based on analysis of data after GPS week 1632.

PRN	Type	Mean dX (mm)	RMS (mm)	Mean dY (mm)	RMS (mm)	Mean dZ (mm)	RMS (mm)	#
01	IIF	4.9	22.8	-16.9	19.3	-100.8	65.5	44
02	IIR-B	37.9	35.1	-4.8	8.8	-32.6	73.9	55
03	IIA	5.7	21.4	-4.1	25.5	39.8	81.0	55
04	IIA	-5.4	20.4	21.8	11.0	-72.6	80.0	55
05	IIR-M	22.7	29.6	-3.0	11.0	-21.9	74.7	55
06	IIA	-1.0	19.4	-5.2	14.1	36.0	87.2	55
07	IIR-M	17.7	10.7	2.7	8.0	-0.9	60.1	55
08	IIA	-13.8	13.9	50.7	30.7	-30.6	68.8	55
09	IIA	-21.8	6.6	1.7	12.4	-69.8	66.9	55
10	IIA	-6.7	18.3	17.8	13.0	-73.0	61.4	55
11	IIR-A	-2.2	20.2	-16.0	12.5	82.7	87.1	55
12	IIR-M	36.9	20.7	-12.7	8.8	-72.0	58.1	55
13	IIR-A	18.4	18.5	-4.1	10.0	38.4	65.3	55
14	IIR-A	25.8	21.9	-2.9	6.9	31.5	63.1	55
15	IIR-M	28.4	20.4	-5.0	9.5	-47.2	102.9	55
16	IIR-A	39.8	24.0	-11.8	9.2	38.1	92.0	55
17	IIR-M	31.1	31.2	-4.7	9.1	-29.6	64.2	55
18	IIR-A	37.5	32.0	-7.3	8.2	-20.9	92.9	55
19	II	36.1	32.0	-8.1	10.7	23.9	60.2	55
20	IIR-A	25.0	33.1	-0.9	9.4	71.3	67.8	55
21	IIR-A	30.5	33.1	2.8	9.2	-11.8	82.8	55
22	IIA	21.5	29.4	2.2	11.8	-26.7	83.7	55
23	IIR-B	37.5	20.1	-4.9	8.4	23.2	65.8	55
24	IIR-M	-10.6	31.3	12.7	23.5	122.8	51.8	21
25	IIF	-8.1	10.6	-29.1	16.8	-112.1	82.1	55
26	IIA	-5.8	10.9	27.4	11.1	-90.2	88.9	55
27	IIA	-17.4	8.8	32.8	13.6	-73.9	62.2	55
28	IIR-A	24.3	23.5	3.5	8.4	0.5	57.1	55
29	IIR-M	39.1	33.5	-9.8	10.4	-41.9	94.5	55
30	IIA	0.6	16.0	-13.7	17.7	27.6	68.7	42
31	IIR-M	19.2	10.4	-0.0	7.2	-1.5	69.6	55
32	IIA	7.6	19.8	38.6	20.2	10.6	79.8	55

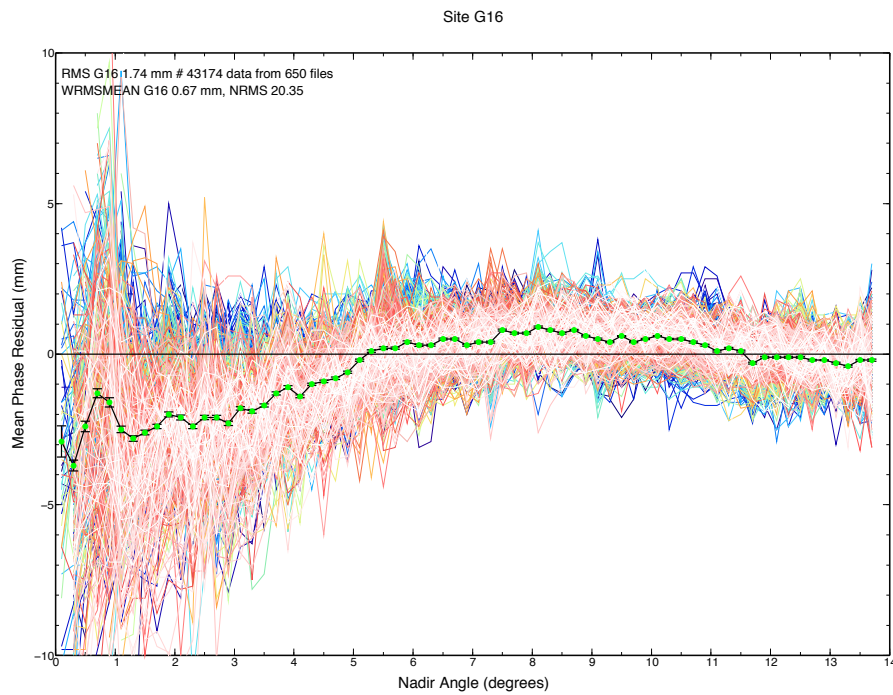

Figure 2: RMS scatter of the mean phase residuals by satellite based on the accumulation of 18 weeks of nadir averaged phase residuals.

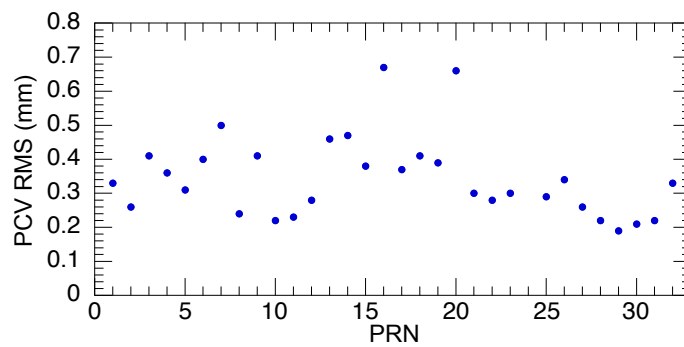

Figure 3: Phase residuals to PRN 16 as function of nadir angle. Each line is from one day of data and the color of line progresses from blues to reds as a function of time. The green dots show the average values. The phase center location is fixed to the IGS08 value.

United States Naval Observatory Analysis Center Report 2011

C. Hackman, S. Byram, V. Slabinski, and J. Tracey

United States Naval Observatory
3450 Massachusetts Avenue Northwest
Washington DC 20392 USA
e-mail: christine.hackman@usno.navy.mil
phone: 202 762 1428

1 Introduction

The United States Naval Observatory (USNO), located in Washington, DC, USA has served as an IGS Analysis Center (AC) since 1997, contributing to the IGS Rapid and Ultra-rapid Combinations since 1997 and 2000, respectively. At present, USNO contributes a full suite of rapid products (orbit and clock estimates for the GPS satellites, earth rotation parameters (ERPs), and receiver clock estimates) once/day to the IGS by the 1600 UTC deadline, and contributes the full suite of ultra-rapid products (post-processed and predicted orbit/clock estimates for the GPS satellites; ERPs) four times/day by the pertinent IGS deadline. USNO submitted 100% of its rapid products and 99% of its ultra-rapid products to the IGS on time in 2011.

In a new role assumed in 2011, USNO now serves as the production center for IGS Final Troposphere Estimates, computing and distributing 5-min GPS-based troposphere estimates for all 300+ receivers of the IGS network. USNO also now chairs the IGS Troposphere Working Group (IGSTWG).

The USNO AC is hosted in the GPS Analysis Division (GPSAD) of the USNO Earth Orientation Department (EOD). Dr. Christine Hackman, GPSAD chief, directs AC activities and chairs the IGSTWG. Dr. Sharyl Byram oversees production of the IGS Final Troposphere estimates. All GPSAD members, including Dr. Victor Slabinski and Mr. Jeffrey Tracey, participate in AC work.

USNO AC products are computed using Astronomical Institute of the University of Bern

Bernese GPS Software (Dach et al., 2007).¹ In 2011, rapid products were generated using a combination of network and precise point positioning (PPP) (Zumberge et al., 1997) methods. Ultra-rapid products were generated using network solutions.

In addition to its AC and troposphere products, GPSAD generates a UT1–UTC-like quantity, UTGPS, four times/day. UTGPS is used by the IERS Rapid Combination/Prediction Service in predicting UT1–UTC as an extrapolator for VLBI UT1–UTC measurements. Mr. Tracey oversees UTGPS. For more information, please contact the AC.

USNO rapid, ultra-rapid and UTGPS products can be downloaded immediately after computation from <http://www.usno.navy.mil/USNO/earth-orientation/gps-products>.

2 Accomplishments/Strengths 2011

As mentioned previously, the AC maintained 100% and 99% on-time submission rates for the rapid and ultra-rapid products in 2011, making a successful transition to the new IGS08 reference frame on 17 April 2011 with no interruption in operations. Dr. Slabinski played a key role in on-time submissions by continually improving AC code to handle previously unseen failure modes.

Dr. Byram, with help from Mr. Tracey, set up IGS Final Troposphere operations, with the AC assuming full computation/distribution duties in July 2011, as promised to the IGS Governing Board in April 2011. Dr. Byram also back-filled missing troposphere estimates for 17 April 2011 — July 2011, presenting all of the above work at ION GNSS 2011 (cf. “Publications”).

Dr. Hackman meanwhile re-organized the IGSTWG, recruiting new members (and confirming the continued interest of existing ones), re-drafting the charter, drafting initial action plans, and planning a member survey that was ultimately distributed in 2012. Further details of IGS troposphere-related work can be found in *IGS Troposphere Working Group 2011* (this volume).

Other accomplishments: Dr. Sharyl Byram conducted an experiment in which she added GLONASS data to USNO processing. This bore fruit in 2012: she presented said work in an oral presentation at the ION PLANS 2012 conference. In addition to chairing IGS troposphere activities, Dr. Hackman was appointed to the IGS Associated Membership Committee and the IGS Governing Board.

¹Prior to 2009, the rapid products were computed using Jet Propulsion Laboratory (JPL) *GPS Inferred Positioning System* (GIPSY; Webb and Zumberge, 1997).

3 2011 Publications/Presentations Pertaining to USNO IGS Work

Byram, S., C. Hackman, and J. Tracey. Computation of a High-Precision GPS-Based Troposphere Product by the USNO. *Proc. ION GNSS 2011*, 572–578, 2011.

Hackman, C. Impact of Network De-Densification on GPS-Estimated Polar Motion: a Simulation Study. Poster, *European Geosciences Union General Assembly*. 2011a.

Hackman, C. and D. Matsakis. Precision and Accuracy of USNO GPS Carrier Phase Time Transfer: Further Studies. *Proc. 2011 Joint Conference, IEEE International Frequency Control Symposium (IFCS) & European Frequency and Time Forum*, 1046–1051, 2011.

Hackman, C.. High-Precision Low-Latency GPS-Carrier-Phase-Based Satellite Orbits, Clocks and Geophysical Parameters Available from the USNO. *Proc. 2011 Joint Navigation Conference*, 1163–1177, 2011b.

4 Product Performance 2011

Figures 1–4 show the 2011 performance of USNO rapid and ultra-rapid products, with summary statistics given in Table 1. USNO rapid orbits had a median weighted RMS (WRMS) of 14 mm with respect to (wrt) the IGS rapid combined orbits. The USNO ultra-rapid orbits had median WRMSs of 21 mm (24-h post-processed segment) and 50 mm (6-h

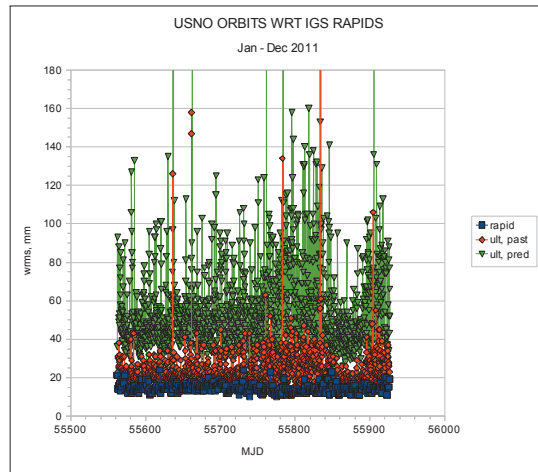

Figure 1: Weighted RMS of USNO GPS orbit estimates with respect to IGS Rapid Combination, 2011. “Ult, past” refers to 24-hour post-processed section of USNO ultra-rapid orbits. “Ult, pred” refers to first six hours of ultra-rapid orbit prediction.

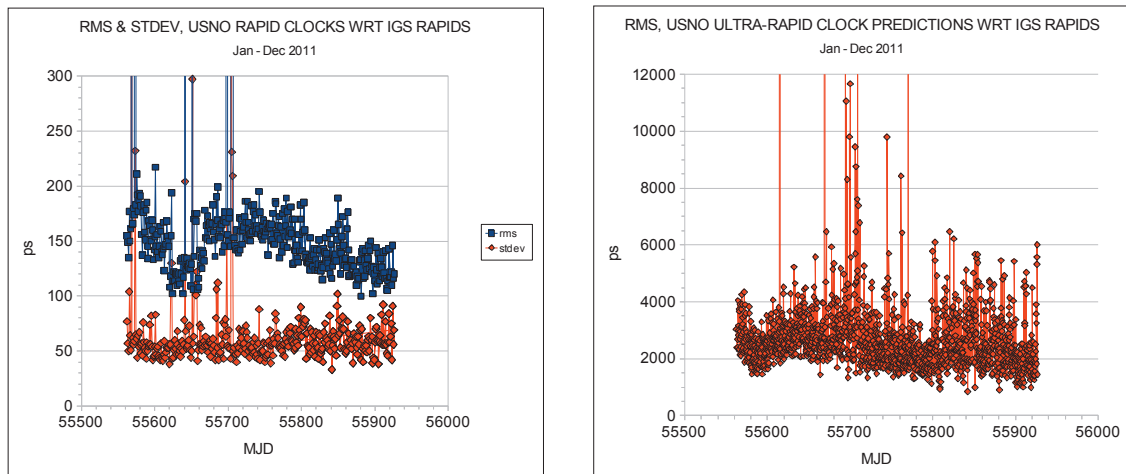

Figure 2: RMS/standard deviation of USNO rapid GPS clock estimates (left) and RMS of USNO ultra-rapid GPS clock predictions (right) with respect to IGS Rapid Combination, 2011.

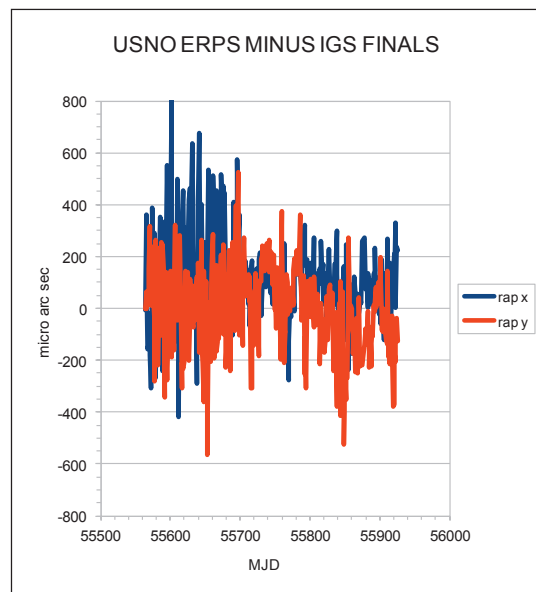

Figure 3: Difference between USNO rapid polar motion estimates and IGS Final Combination, 2011.

predict) wrt the IGS rapid combined orbits. In the future, a comparison of AC ultra-rapid orbits to the IGS ultra-rapid combination will be considered as well.

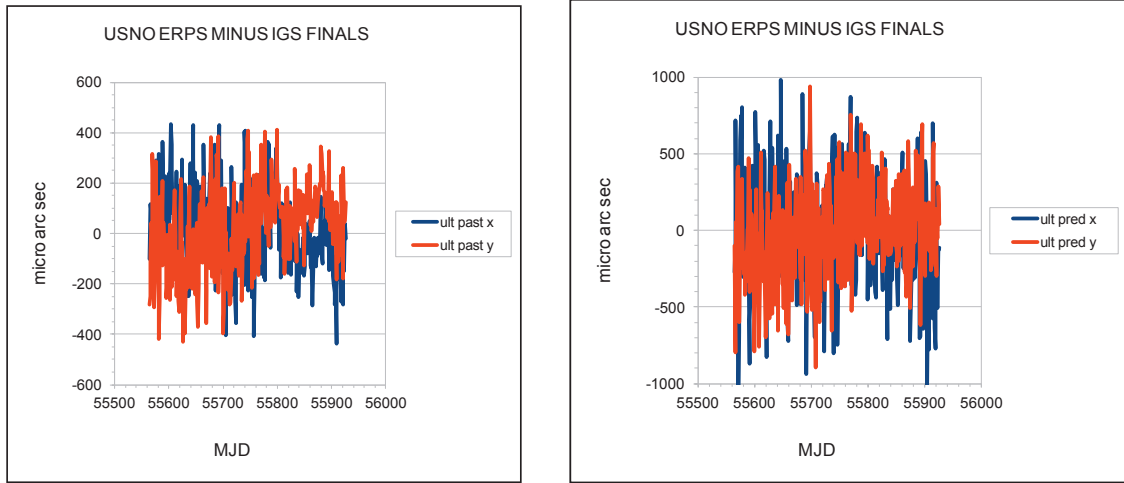

Figure 4: Difference between USNO ultra-rapid polar motion estimates and IGS Final Combination, 2011.

USNO rapid clocks had a 57 ps standard deviation (STDEV) and 144ps RMS wrt IGS combined rapid clocks. USNO ultra-rapid clock predictions (first six h) had a 2449 ps RMS wrt IGS combined rapid clocks. While the RMS of USNO rapid clocks decreased after MJD 55800/27 Aug 2011 (Fig. 2), the STDEV became slightly larger; the RMS of the ultra-rapid predictions increased after this date as well. The cause of this change is unknown.

USNO rapid polar motion (PM) estimates had RMS differences wrt IGS final combined values of (x, y) 196 and 162 micro arc sec. USNO ultra-rapid PM estimates differed from IGS final combined values (x, y) by 158 and 164 micro arc sec for the 24-h post-processed segment and 362 and 303 micro arc sec for the 24-h predict.

The troposphere production center is still in the process of developing quality metrics.

Table 1: RMS Performance of USNO Rapid and Ultra-rapid Products 2011 (date: 1/1/11–12/31/11).

USNO GPS satellite orbits			USNO GPS-based polar motion estimates			USNO GPS-based clock estimates	
Statistic: median weighted RMS wrt IGS combined rapid orbit estimates units: mm			Statistic: RMS difference wrt IGS combined final product units: 10 ⁻⁶ arc sec			Statistic: median RMS, standard dev. wrt IGS combined rapid clock product units: ps	
rapid	ultra-rapid		rapid	ultra-rapid		rapid	ultra-rapid
	past 24 h	6-h predict		past 24 h	24-h predict	past 24 h	6-h predict
14	21	50	x:196	x:158	x:362	STDEV: 57	RMS: 2449
			y:162	y:164	y:303	RMS: 144	

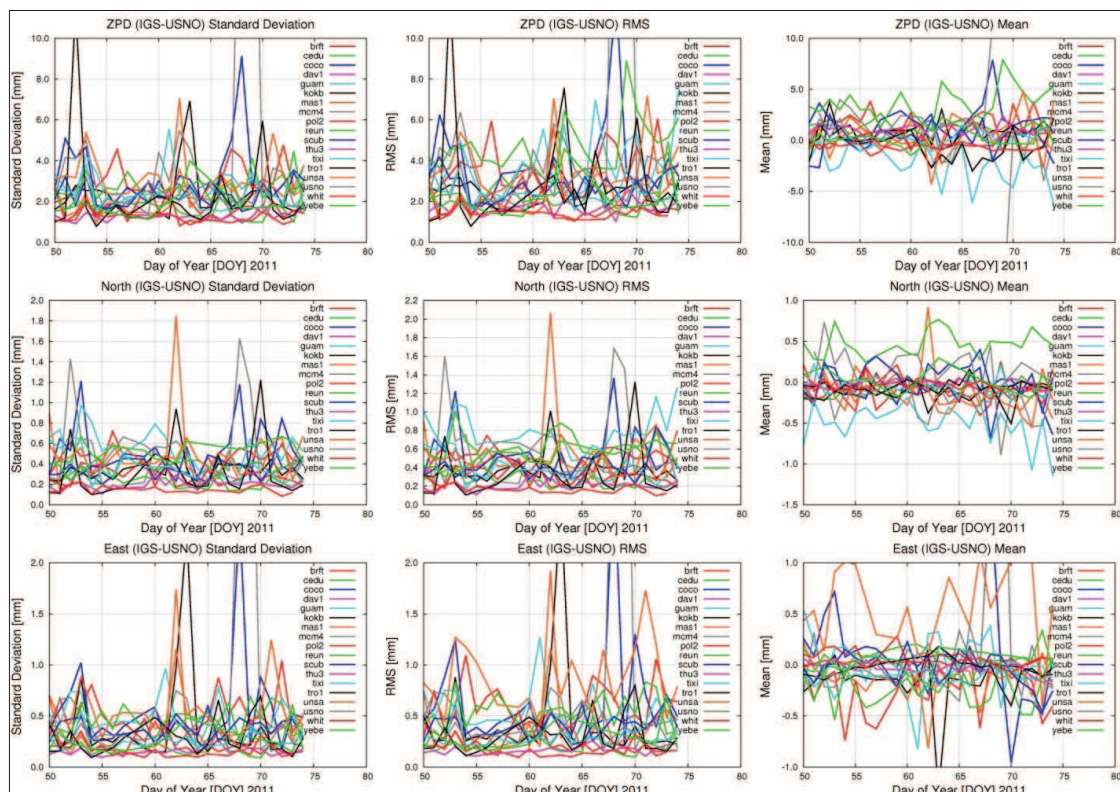

Figure 5: Comparison of USNO test troposphere solutions to existing IGS Final Troposphere estimates, in preparation for operational transition to USNO. ZPD = total zenith troposphere delay. Days of year 50–74 (28 Feb—14 Mar) 2011. From Byram et al. (2011).

However, Fig. 5 shows a comparison of USNO test troposphere solutions (computed prior to assumption of duties) and existing IGS final troposphere estimates. The USNO estimates agreed with existing IGS Final Estimates with RMSs of 2.95 mm (total vertical zenith delay) and 0.42 mm (both north and east components). Once duties were transferred, USNO submitted more than 82,000 IGS Final Troposphere Estimate files, covering the period 17 Apr–31 Dec 2011.

5 Areas Requiring Improvement

USNO excels in on-time product submission. Its post-processed orbits and ultra-rapid clock products (both post-processed and predicted) contribute usefully to the IGS combinations. The assumption of IGS final troposphere estimation duties went according to plan. However, we recognize the need for improvement in several areas.

First, we need to increase the number of stations processed in the network solution. Whereas most ACs process approximately 100, we are presently limited to 34 or so. This problem can be solved by exploiting the Bernese capability to process multiple small network solutions and combine the normal equations. We have had test versions of this running since 2010 but have yet to obtain satisfactory results.

Next: USNO rapid and ultra ERPs, while unbiased, are noisy relative to other AC submissions and are thus not included in the combinations. We adjusted several processing parameters in 2011 in an effort to address this — for example, we were not implementing the IGS reference stations optimally — and while this helped, the problem remains. Adding more stations to the network solution would likely improve the situation, as the simulation studies of Hackman (2011a) showed. Work continues, with a resolution goal date of December 2012.

Finally: USNO rapid clocks have a large STDEV wrt IGS combined rapid clocks, compared to other-AC submissions, and are thus also omitted from the combination. The matter is under continuing investigation.

6 Future Plans

The primary work of 2012 will be to address the problems above. Additionally, the USNO AC will be very active at the IGS 2012 Workshop, attending all governing board meetings, chairing the troposphere plenary, poster and splinter sessions, and presenting three posters re the AC, the troposphere production center, and USNO GLONASS processing. Lastly, GLONASS processing will be implemented into AC submissions if ongoing tests indicate it is so warranted.

References

- Dach, R., U. Hugentobler, P. Fridez, M. Meindl (eds). *Bernese GPS Software Version 5.0* (user manual). Astronomical Institute of University of Bern, Bern, Switzerland, 2007.
- Zumberge, J. F., M. B. Heflin, D. C. Jefferson, M. M. Watkins, and F. H. Webb. Precise Point Positioning for the Efficient and Robust Analysis of GPS Data from Large Networks. *J. Geophys. Res.*, 102(B3):5005–17, 1997.
- Webb, F. H. and J. F. Zumberge (eds.). An Introduction to GIPSY/OASIS-II: Precision Software for the Analysis of Data from the Global Positioning System. JPL internal publication D-11088, Jet Propulsion Laboratory, Pasadena, California, 1997.

IGS Regional Network Associate Analysis Centre for SIRGAS (IGS RNAAC SIR)

L. Sánchez

Deutsches Geodätisches Forschungsinstitut (DGFI)
Alfons-Goppel-Str. 11, D-80539 Munich, Germany
e-mail: sanchez@dgfi.badw.de

1 Introduction

The *IGS Regional Network Associate Analysis Centre for SIRGAS* (IGS RNAAC SIR) was installed in June 1996 under the responsibility of the *Deutsches Geodätisches Forschungsinstitut* (DGFI) (Seemüller and Drewes, 2008; Sánchez et al., 2010). The main objective is the permanent analysis of the SIRGAS reference frame, which is given at present by about 250 continuously operating GNSS stations (Fig. 1). The activities of the IGS RNAAC SIR concentrate on:

1. The computation of loosely constrained weekly solutions for further combinations of the network (e.g. integration into the IGS polyhedron, computation of cumulative solutions, etc.). These solutions are weekly delivered to the IGS in SINEX format to be combined together with those generated by the other IGS Global and Regional Analysis Centres. They are named `sirwww7.snx` (www stands for the GPS week);
2. Weekly station positions aligned to the same reference frame in which the IGS GNSS orbits are given; i.e. the IGS reference frame. These positions are applied as reference values for surveying applications in Latin America. Their name is `siryypwww.crd` (yy indicates the last two digits of the year).
3. Multi-year solutions providing station positions and velocities to estimate the kinematics of the reference frame and as support for applications requiring coordinate time-dependence. They are identified by `SIRyyPnn.SNX` (being nn the number of the cumulative solutions computed in one year).

The SIRGAS reference frame was regularly computed by the IGS RNAAC SIR as only one network until August 31, 2008 (GPS week 1495) (Seemüller et al., 2012). Afterwards, due to the increasing number of stations, different sub-networks were defined and, at present,

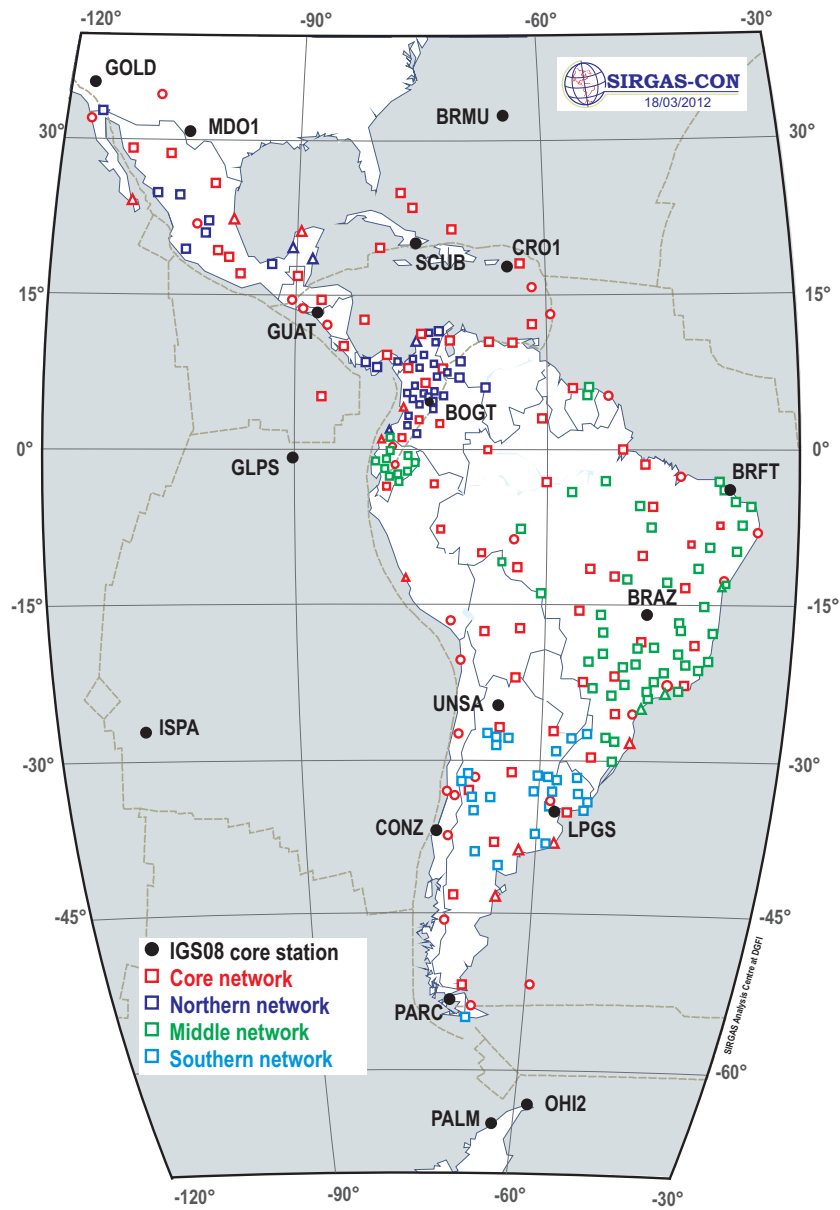

Figure 1: SIRGAS Reference Frame (status 2012-03-12).

the analysis strategy is based on the combination of individual solutions including (Brunini et al., 2012):

- One core network with about 120 stations distributed over the whole continent, and
- different densification sub-networks distributed regionally on the northern, middle, and southern part of the continent (Fig. 1).

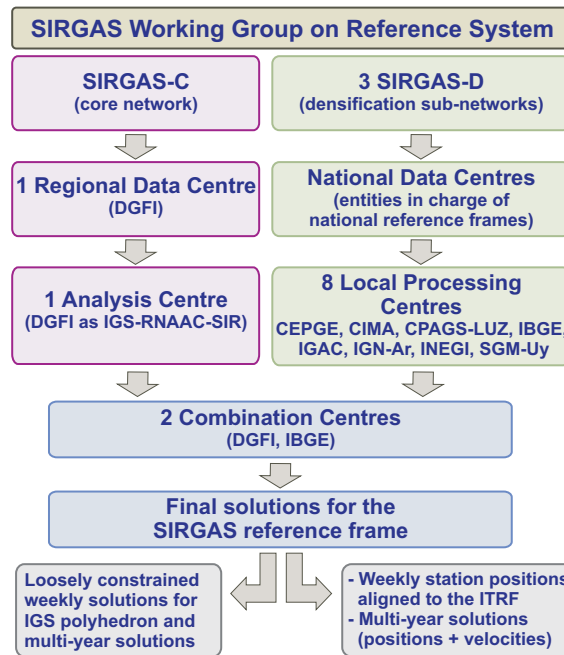

Figure 2: Dataflow within the weekly analysis of the SIRGAS Reference Frame.

The SIRGAS core network provides a direct densification of the ITRF in Latin America and the regional sub-networks improve the geographical density of the core network. This hierarchy guarantees the precise accessibility to the global reference frame at national and local levels. Although, core and regional sub-networks appear as two different categories, their stations match requirements, characteristics, performance, and quality of ITRF stations.

The different sub-networks are individually processed by the SIRGAS Analysis Centres: the core network is computed by DGFI (Germany, Sánchez and Seitz, 2011), the other sub-networks by the SIRGAS Local Processing Centres: CEPGE (Ecuador), CIMA (Argentina), CPAGS-LUZ (Venezuela), IBGE (Brazil), IGAC (Colombia), IGN (Argentina), INEGI (Mexico), and SGM (Uruguay). These Processing Centres deliver loosely constrained weekly solutions for the assigned SIRGAS sub-networks. In these solutions, satellite orbits, satellite clock offsets, and Earth orientation parameters are fixed to the final weekly IGS values, and positions for all sites are constrained to ± 1 m. The individual contributions are integrated in a unified solution by the SIRGAS Combination Centres: DGFI (Sánchez et al., 2012a) and IBGE (Costa et al., 2012). The distribution of the SIRGAS stations within the SIRGAS Processing Centres guarantees that each station is included in three solutions. Fig. 2 shows the dataflow within the SIRGAS processing.

According to this, the IGS RNAAC SIR is now responsible for (Seemüller et al., 2012; Sánchez and Seitz, 2011)

1. processing the SIRGAS core network;
2. combining this core network with the densification sub-networks; and
3. making available the SIRGAS products, i.e.: loosely constrained weekly solutions, weekly station positions aligned to the ITRF, and multi-year solutions describing the kinematics of the reference frame.

The analysis of the SIRGAS reference frame as a regional densification of the ITRF is based on the IGS final products (Sánchez and Brunini, 2009). Consequently, the SIRGAS weekly solutions are given in the same reference frame applied by the IGS for the calculation of its products; namely, the IGS05 until week 1631 and the IGS08 since week 1632 (Sánchez and Seitz, 2011). Here it should be mentioned that the former SIRGAS weekly solutions from GPS week 1042 to 1399 using relative antenna phase centre corrections and referring to different ITRF or IGS reference frames were reprocessed using the `igs05.atx` model and the IGS05 frame (Seemüller et al., 2012). Reprocessed solutions are identified with the name `si1www.snx` to be distinguished from the old weekly solutions.

2 Kinematics of the SIRGAS reference frame

To estimate the kinematics of the SIRGAS reference frame, a cumulative (multi-year) solution is computed (updated) every year, providing epoch positions and constant velocities for stations operating longer than two years. The coordinates of the multi-year solutions refer to the latest available ITRF and to a specified epoch, e.g. the most recent SIRGAS-CON multi-year solution SIR11P01 (Fig. 3) refers to ITRF2008, epoch 2005.0. It includes 230 stations with 269 occupations and its precision was estimated to be ± 1.0 mm (horizontal) and ± 2.4 mm (vertical) for the station positions, and ± 0.7 mm/a (horizontal) and ± 1.1 mm/a (vertical) for the constant velocities (Sánchez and Seitz, 2011).

Since the switch to IGS08 reference frame causes a discontinuity of some millimetres in the station position time series, this solution is the last one that can be computed with the available data. A new multi-year solution of the SIRGAS reference frame demands the re-processing of all previous weekly solutions using the IGS08 frame and the phase centre correction model `igs08.atx`. For that, it is necessary to wait until the IGS has generated the corresponding IGS08-related products (e.g. satellite orbits, EOPs, terrestrial reference station positions, etc.).

3 Impact of seismic events on the SIRGAS reference frame

The western part of the SIRGAS region, i.e. the plate boundary zone between the Pacific, Cocos, and Nazca plates in the west and the North American, Caribbean, and South American plates in the east, is an extremely active seismic area. The frequent occurrence of earthquakes causes episodic station movements, which have to be precisely determined



Figure 3: Horizontal velocities of the multi-year solution SIR11P01.

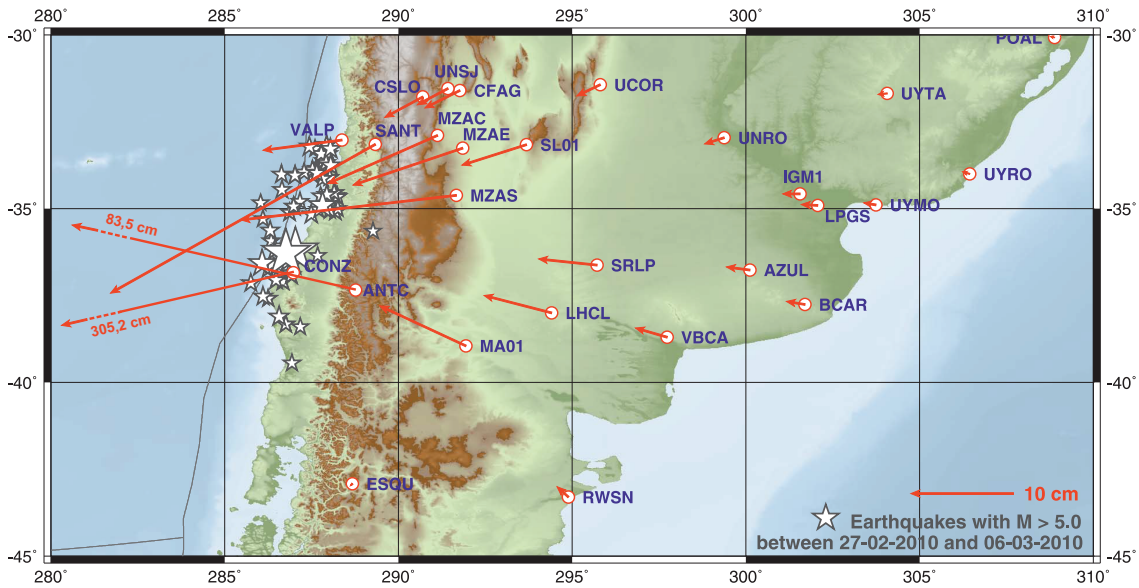

Figure 4: Horizontal displacements caused by the Maule earthquake on 2010-02-27.

and modelled to guarantee the appropriate transformation of station positions between the pre-seismic and the post-seismic (deformed) reference frame (Sánchez et al., 2012b). According to this, always when a strong earthquake shakes the SIRGAS region, the IGS RNAAC SIR attempts to process as soon as possible the available GNSS measurements to estimate the impact on the reference frame. The usual procedure includes the computation of daily normal equations, which are separately solved with respect to IGS reference stations located outside the SIRGAS region, i.e. in Europe, North America, and Africa. By comparing daily station positions before and after the earthquake, it is possible to determine displacements of the SIRGAS-CON reference stations associated to the seism. As an example, Fig. 4 presents displacements computed by DGFI after the earthquake in Chile on 2010-02-27.

4 Improvement of the IGS station coverage in Latin America

After the strong earthquake of February 2010 in the Chilean Region Maule, a huge percentage of existing IGS reference frame stations in South America suffered an irreparable discontinuity in their time series. According to Fig. 4, this earthquake produced co-seismic displacements between 5 m at the Pacific Coast and 2 cm at the Atlantic Coast in Argentina and Uruguay. Additional movements due to the post-seismic relaxation during the first months after the main earthquake and its aftershocks are also evident in the station position time series. Thereby, the reliability of the recently launched IGS08 reference frame decreased considerably in South America and the affected stations are no longer

4 Improvement of the IGS station coverage in Latin America

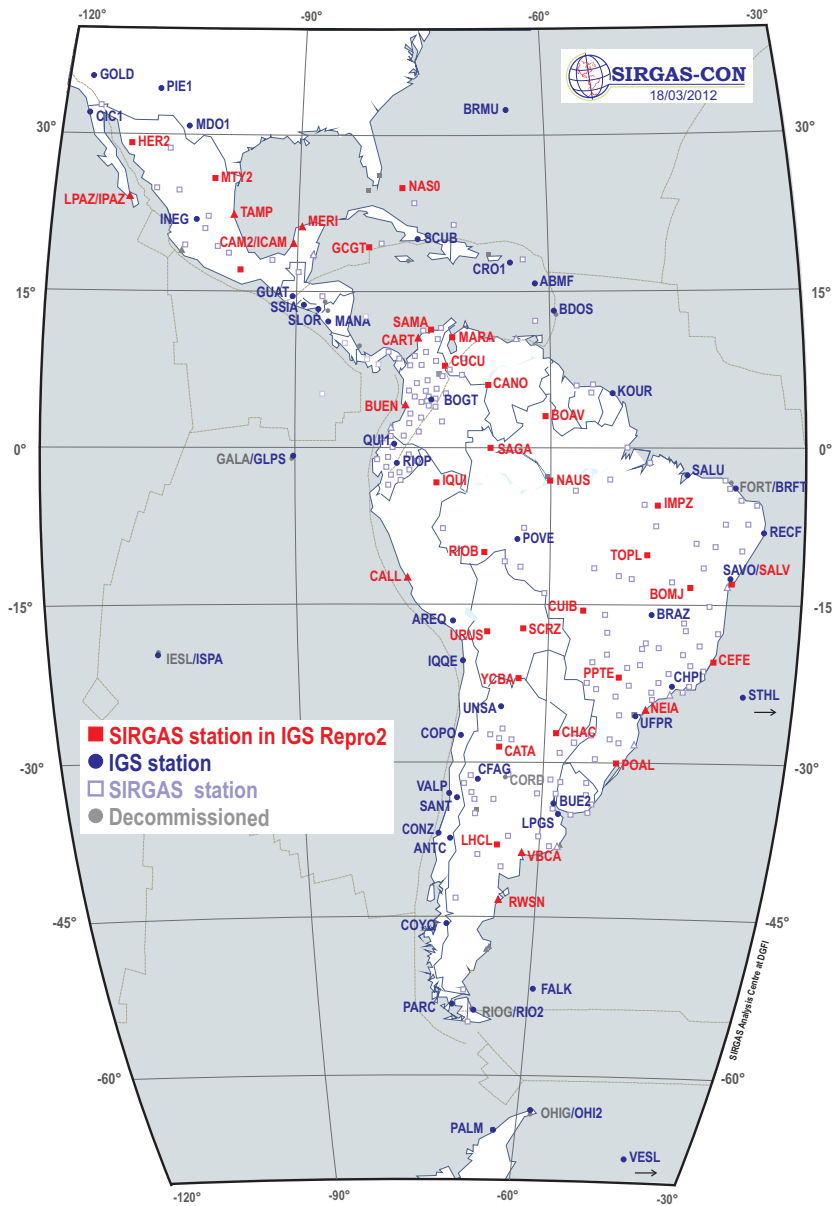

Figure 5: SIRGAS stations to be included in the second IGS reprocessing campaign.

usable as a basis for the GNSS data analysis or to guarantee the long-term stability of the ITRF in this region. Keeping in mind the achievements reached within the regional reference frame SIRGAS and the planned second reprocessing campaign of the IGS global network, a set of continuously operating SIRGAS stations was proposed to be included in this reprocessing with the main objective of improving the IGS station coverage in Latin America. Initially, the IGS RNAAC SIR, with the support of the national organizations

responsible for the reference frames in the Latin American countries, made a selection of about 70 SIRGAS stations which satisfy the IGS requirements. This selection was evaluated by the IGS Reference Frame Working Group, and after some interaction with the IGS Global Analysis Centres, it was decided to include 40 SIRGAS stations (Fig. 5) not only in the IGS reprocessing but also in the present routine IGS processing. The IGS RNAAC SIR provided the IGS data centres with the metadata and all existing observations (historical data) of the selected stations by the end of January 2012. Present measurements (since the beginning of 2012) of the operational stations are directly provided by the responsible Latin American agencies to the IGS. The next step is to manage, together with the IGS Network Coordinator, the formal integration of these stations in the IGS network.

5 Outlook

In addition to the routine activities, the IGS RNAAC SIR is at present focused on:

1. To analyse and model the seasonal variations within the reference frame computation to increase the reliability and long-term stability of regional reference frames;
2. To determine the best possible strategy for the computation of deformation models that allow the appropriate transformation of station positions between pre-seismic and the post-seismic (deformed) reference frames;
3. To prepare a second reprocessing campaign of all SIRGAS observations available based on the IG2 products.

Acknowledgments

The operational infrastructure and results described in this report are possible thanks to the active participation of many Latin American and Caribbean colleagues, who not only make the measurements of the stations available, but also operate SIRGAS Analysis Centres processing the observational data on a routine basis. The achievements of SIRGAS are a consequence of a successful international geodetic cooperation not only following and meeting concrete objectives, but also becoming a permanent and self-sustaining geodetic community to guarantee quality, reliability, and long-term stability of the SIRGAS Reference Frame. The SIRGAS activities are strongly supported by the International Association of Geodesy (IAG) and the Pan-American Institute for Geography and History (PAIGH). The IGS RNAAC SIR highly appreciates all this support. More details about the activities and new challenges of SIRGAS, as well as institutions and colleagues working on can be found at www.sirgas.org.

References

- Brunini, C., L. Sánchez, H. Drewes, S. Costa, V. Mackern, W. Martínez, W. Seemüller, and A. da Silva. Improved Analysis Strategy and Accessibility of the SIRGAS Reference Frame. In: Kenyon S., M. C. Pacino, U. Marti (Eds.), *Geodesy for Planet Earth*, IAG Symposia, 136: 3–10, 2012.
- Costa, S. M. A., A. L. Silva, and J. A. Vaz (2012). Report on the SIRGAS–CON Combined Solution by IBGE Analysis Center. In: Kenyon S., M. C. Pacino, U. Marti (Eds.), *Geodesy for Planet Earth*, IAG Symposia, 136: 853–858, 2012.
- Sánchez, L. and C. Brunini. Achievements and Challenges of SIRGAS. In: Drewes H. (Ed.): *Geodetic Reference Systems*, IAG Symposia; 134: 161–166, 2009. doi: 10.1007/978-3-642-00860-3_25.
- Sánchez, L., W. Seemüller, M. Seitz, B. Forberg, F. Leismüller, and H. Arenz. SIRGAS: das Bezugssystem für Lateinamerika und die Karibik. *Zeitschrift für Vermessungswesen*, 135(2), 2010.
- Sánchez, L. and M. Seitz. Recent activities of the IGS Regional Network Associate Analysis Centre for SIRGAS (IGS RNAAC SIR). DGFI Report No. 87, Munich, 2011.
- Sánchez, L., W. Seemüller, and M. Seitz (2012a). Combination of the Weekly Solutions Delivered by the SIRGAS Processing Centres for the SIRGAS–CON Reference Frame. In: Kenyon S., M. C. Pacino, U. Marti (Eds.), *Geodesy for Planet Earth*, IAG Symposia, 136: 845–852, 2012.
- Sánchez, L., W. Seemüller, H. Drewes, L. Mateo, G. González, A. da Silva, J. Pampillón, W. Martínez, V. Cioce, D. Cisneros, and S. Cimbaro. Long–term stability of the SIRGAS Reference Frame and episodic station movements caused by the seismic activity in the SIRGAS region. Proceedings of the *IAG Symposium REFAG2010*, Springer (in press), 2012.
- Seemüller, W. and H. Drewes. Annual Report 2003–2004 of IGS RNAAC SIR. In: *IGS 2003–2004 Technical Reports*, IGS Central Bureau, (eds), Pasadena, CA: Jet Propulsion Laboratory, 2008.
- Seemüller, W., M. Seitz, L. Sánchez, and H. Drewes. The new Multi–year Position and Velocity Solution SIR09P01 of the IGS Regional Network Associate Analysis Centre (IGS RNAAC SIR). In: Kenyon S., M. C. Pacino, U. Marti (Eds.), *Geodesy for Planet Earth*, IAG Symposia, 136: 877–884, 2012.

Part III
Data Centers

Infrastructure Committee Report 2011

I. Romero

ESA/ESOC, Darmstadt, Germany

The Infrastructure Committee is set with the task of studying and advising on infrastructure issues to the IGS Governing Board and the IGS network Coordinator. The latest status and recent progress of the Committee is detailed below for 2011.

1 Membership

Current Members appointed 3 April, 2011 for 2 year terms:

- Carine Bruyninx (OMA)
- Lou Estey (UNAVCO)
- Gary Johnston (GA)
- Ignacio (Nacho) Romero — Chairman — (ESA/ESOC)
- Mike Schmidt (NRCan)
- Georg Weber (BKG)

Ex-officio Members:

- Steve Fisher — Central Bureau
- Jim Ray — Analysis Coordinator
- Mark Caissy — Real time Working Group Chair
- Bruno Garayt — Reference Frame Coordinator
- Carey Noll — Data Center Working Group Chair
- Ken Senior — Clock Products Coordinator

2 Activities in 2011:

- Continued refinement with the IGS CB of the updated *Site Guidelines*, waiting for publication by the CB after further review and open comment period.

- Helped to organize and support the test campaign to assess the impact of *un-calibrated Domes at co-located sites* (together with CB, ACC, RFWG and AWG):
 - This campaign has requested from organizations with co-located stations using un-calibrated Domes over their GNSS antennas that they remove the Domes for an 8-week period, and then returns the Dome to its position, so as not to break the long-term position time series. This test campaign attempts to determine whether the effect of the un-calibrated Dome can be properly characterized from the AC Sinex solutions by the Reference-Frame Working Group combination and analysis method.

So far the following stations have participated with removing their uncalibrated Domes:

	Removal	Re-installation
CRO1	01-Apr-2011	24-Jun-2011
TSKB	01-Jul-2011	30-Aug-2011
TSK2	01-Jul-2011	30-Aug-2011
AREQ	19-Aug-2011	03-Feb-2012
FAIR	28-Apr-2012	On-going
YAR2	28-Apr-2012	On-going

- Supported the IGS CB (Robert K., David M.) on station issues; introduction of new stations in India (lcki, pbri) and elsewhere, decommissioning of stations (bran, etc), handling un-calibrated Antenna+Dome pairs, etc. .
- Making some progress to recover long dormant stations: such as yibl, bhr1/2, pre1/2, and many other NGA stations no longer submitting data due to un-calibrated antennas at previously available IGS stations (with DCWG, CB, AWG, ACC).
- Maintained the internal IC webpage with information for the IC members, GB and NC on station data arrival statistics, station availability, Reference Frame station usage, RINEX header / station log inconsistencies, etc. .
- Participated in the Real-Time Pilot Project telecons and discussions on the “Multi Signal Message” definition to ensure full compatibility of the streaming standard and Rinex 3.01 .
- Assisted in the RINEX “way forward” helping to establish the RINEX working group within the IGS and the RTCM (with RTPP, ACC, GB).
- Made recommendations and comments on the QZSS data format as sample files have become available from JAXA to ensure that they follow the RINEX definition.
- Assisted in the selection of additional reference frame candidate stations from Central and South America and from Africa (with RFWG and ACC).
- Clarified with the CB and the RFWG the location of the station logs for the IGS “proposed stations” .

3 Continued activities for 2012–2013:

- Finalize the un-calibrated Dome experiment for co-located stations and promote in-depth result analysis for IGS WS 2012 presentation.
- Promote continued progress on the streaming and RINEX data formats to accommodate the new systems (QZSS, etc) (with RTPP).
- Help the IGS in the IGS WS 2012 preparations to properly cover infrastructure issues (with CB, Workshop organizing committee, etc).

4 Activities planned to support IGS MGEX:

Continued evaluation and assessment of capabilities by different GNSS equipment vendors as to their compliance to the RINEX standard for GNSS data (Rinex 3), provision of regional GNSS data (QZSS, Compass), etc.

CDDIS Global Data Center Technical Report 2011

C. Noll

NASA Goddard Space Flight Center, Code 690.1
Greenbelt, MD 20771 USA
Carey.Noll@nasa.gov

1 Introduction

The CDDIS is NASA's data archive and information service supporting the international space geodesy community. For over 30 years, the CDDIS has provided continuous, long term, public access to the data (mainly GNSS — Global Navigation Satellite System, SLR — Satellite Laser Ranging, VLBI — Very Long Baseline Interferometry, and DORIS — Doppler Orbitography and Radiopositioning Integrated by Satellite) and products derived from these data required for a variety of science observations, including the determination of a global terrestrial reference frame and geodetic studies in plate tectonics, earthquake displacements, volcano monitoring, Earth orientation, and atmospheric angular momentum, among others. The specialized nature of the CDDIS lends itself well to enhancement to accommodate diverse data sets and user requirements. The CDDIS is one of NASA's Earth Observing System Data and Information System (EOSDIS) distributed data centers; EOSDIS data centers serve a diverse user community and are tasked to provide facilities to search and access science data and products.

The CDDIS serves as one of the primary data centers and core components for the geometric services established under the International Association of Geodesy (IAG), an organization that promotes scientific cooperation and research in geodesy on a global scale. The system has supported the International GNSS Service (IGS) as a global data center since 1992. The CDDIS activities within the IGS during 2011 are summarized below; this report also includes any recent changes or enhancements made to the CDDIS.

2 System Description

The CDDIS archive of IGS data and products are accessible worldwide through anonymous ftp. The CDDIS is located at NASA's Goddard Space Flight Center (GSFC) and is available to users 24 hours per day, seven days per week.

The CDDIS computer system consists of incoming, outgoing, and processing servers. All ftp and web access is performed on the outgoing server, which is equipped with a hot spare. Data centers, stations, and analysis centers push files to the CDDIS incoming server, which is also configured with a hot spare. Processing of incoming files for the on-line archive is performed in a separate environment that also includes a database server for managing metadata extracted from incoming data.

3 Archive Content

As a global data center for the IGS, the CDDIS is responsible for archiving and providing access to GNSS data from the global IGS network as well as the products derived from the analyses of these data in support of both operational and working group/pilot project activities. Approximately 6 Tbytes of the CDDIS archive are devoted to GNSS data (5.5 Tbytes), products (250 Gbytes), and ancillary information. All data and products are accessible through subdirectories of <ftp://cddis.gsfc.nasa.gov/gnss> (a symbolic link to <ftp://cddis.gsfc.nasa.gov/gps>).

3.1 GNSS Tracking Data

The user community has access to the on-line archive of GNSS data available through the global data center archives of the IGS. Over 50 operational and regional IGS data centers and station operators make data (observation, navigation, and meteorological) available in RINEX format to the CDDIS from selected receivers on a daily, hourly, and sub-hourly basis. The CDDIS also accesses the archives of the other three IGS global data centers, Scripps Institution of Oceanography (SIO) in California, the Institut Géographique National (IGN) in France, and the Korea Astronomy and Space Science Institute (KASI) to retrieve (or receive) data holdings not routinely transmitted to the CDDIS by an operational or regional data center. Tables 1 and 2 summarize the types of GNSS data archived at the CDDIS.

Data, in RINEX V2.10 or V2.11 format, from GPS and GPS+GLONASS receivers are archived within the GNSS directory structure `/gnss/data`.

The CDDIS archives four major types/formats of GNSS data, all in RINEX format, as described in Table 1. Daily RINEX data are quality-checked, summarized, and archived to public disk areas in subdirectories by year, day, and file type; the summary and inventory information are also loaded into an on-line database. Nearly 150K station days from 490 distinct GNSS receivers were archived at the CDDIS during 2011; a complete list of these sites can be found in the yearly summary reports at URL <ftp://cddis.gsfc.nasa.gov/reports/gnss/>.

Table 1: GNSS Data Type Summary.

Data Type	Sample Rate	Data Format	Available On-line
Daily GNSS	30 sec.	RINEX and compact RINEX	Since 1992
Hourly GNSS	30 sec.	Compact RINEX	2+ years
High-rate GNSS	1 sec.	Compact RINEX	Since May 2001
Satellite GPS	10 sec.	Compact RINEX	Since 2002

Table 2: GNSS Data Archive Summary for 2011.

Data Type	Avg. No. Sites/Day	Avg. Vol./Day	Total Vol./Year	Directory Location	Latency of Majority of Data
Daily GNSS	425	850 Mb	285 Gb	/gnss/data/daily	1 hour
Hourly GNSS	260	300 Mb	95 Gb	/gnss/data/hourly	10 minutes
High-rate GNSS	135	1500 Mb	460 Gb	/gnss/data/highrate	10 minutes
LEO GPS	1	0.5 Mb	200 Mb	/gnss/data/satellite	10 days

Within minutes of receipt, the hourly GNSS files are archived to subdirectories by year, day, and hour. These data are retained on-line indefinitely; the daily files delivered at the end of the UTC day contain all data from these hourly files and thus can be used in lieu of the individual hourly files.

High-rate (typically 1-second sampling) GNSS data are archived in files containing fifteen minutes of data and in subdirectories by year, day, file type, and hour. Many of these data files are created from real-time streams.

The CDDIS generates a global broadcast ephemeris file on an hourly basis. This file is derived from the site-specific ephemeris data files for each day/hour. These files are appended to a single file that contains the orbit information for all GNSS satellites for the day up through that hour. This merged ephemeris data file is then copied to the day's subdirectory within the hourly data file system. Within 1–2 hours after the end of the UTC day, after sufficient station-specific navigation files have been submitted, this concatenation procedure is repeated to create the daily broadcast ephemeris file, using daily site-specific navigation files as input. The daily file is copied to the corresponding subdirectory under the daily file system. Users can thus download this single, daily (or hourly) file to obtain the unique navigation messages rather than downloading multiple broadcast ephemeris files from the individual stations.

The CDDIS continues to archive data from space-borne GPS receiver data from selected missions (e.g., SAC-C). The staff hopes to add data from other satellites such as Jason, GRACE, and ICESat.

3.2 IGS Products

The CDDIS routinely archives IGS operational products (daily, rapid, and ultra-rapid orbits and clocks, and weekly ERP and station positions) as well as products generated by IGS working groups and pilot projects (ionosphere, troposphere, real-time clocks). The CDDIS currently provides on-line access through anonymous ftp or the web to all IGS products generated since the start of the IGS Test Campaign in June 1992 in the file system `/gnss/products`; products from GPS+GLONASS products are available through this filesystem. Products derived from GLONASS data only continued to be archived at the CDDIS in a directory structure within the file system `/glonass/products`.

The CDDIS also continued to archive combined troposphere estimates in directories by GPS week. Global ionosphere maps of total electron content (TEC) from the IONEX AACs were archived in subdirectories by year and day of year. New ionosphere products include hourly and sub-hourly rapid products and predicted products. Real-time clock comparison products have been archived at the CDDIS in support of the IGS Real-Time Pilot Project since 2009. Table 3 summarizes the GNSS products available through the CDDIS.

In 2011, the archive of products for the first IGS reprocessing campaign (`repro1`) was completed. GNSS data collected by the IGS network from 1994 through 2007 (GPS weeks 0730 through 1459) were re-analyzed by the IGS ACs in a consistent way using the latest models and methodology. The reprocessed files were submitted to the data centers for archive in a “`repro1`” directory structure (`/gnss/products/WWW/repro1`); to maintain consistent access, the original set of IGS products continue to be archived in the weekly directories (`/gnss/products/WWW`).

Table 3: GNSS Product Summary.

Product Type	Number of ACs/AACs	Volume	Directory
Orbits, clocks, ERP, positions	13+Combinations	750 Mb/week	<code>/gnss/products/WWW</code> (GPS, GPS+GLONASS) <code>/glonass/products/WWW</code> (GLONASS only)
Troposphere	Combination	2.5 Mb/day, 930 Mb/year	<code>/gnss/products/troposphere/YYYY</code>
Ionosphere	4+Combination	4 Mb/day, 1.5 Gb/year	<code>/gnss/products/ionex/YYYY</code>
Real-time clocks	Combination	5.5 Mb/week	<code>/gnss/products/rtp/YYYY</code>

3.3 Supporting Information

Daily status files of GNSS data holdings, reflecting timeliness of the data delivered as well as statistics on number of data points, cycle slips, and multipath, continue to be generated by the CDDIS. By accessing these files, the user community can receive a quick look at a day's data availability and quality by viewing a single file. The daily status files are available through the web at URL <ftp://cddis.gsfc.nasa.gov/reports/gps/status>. The daily status files are also archived in the daily GNSS data directories. Ancillary information to aid in the use of GNSS data and products are also accessible through the CDDIS. Weekly and yearly summaries of IGS tracking data (daily, hourly, and high-rate) archived at the CDDIS are generated on a routine basis. These summaries are accessible through the web at URL <ftp://cddis.gsfc.nasa.gov/reports/gps>. The CDDIS also maintains an archive of and indices to IGS Mail, Report, Station, and other IGS-related messages.

4 System Usage

Figure 1 summarizes the usage of the CDDIS for the retrieval of GNSS data and products in 2011. This figure illustrates the number and volume of GNSS files retrieved by the user community during 2011, categorized by type (daily, hourly, high-rate, products). Over 500 million files (40 Tbytes) were transferred in 2011, with an average of over 40 million files per month. Figure 2 illustrates the profile of users accessing the CDDIS IGS archive during 2011. The majority of CDDIS users are from hosts in North America and Europe.

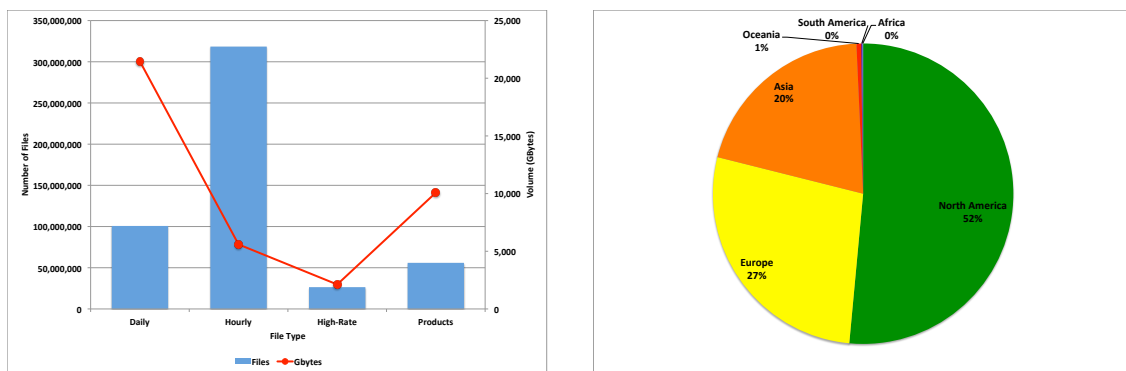

Figure 1: Number and volume of GNSS files transferred from the CDDIS in 2011.

Figure 2: Geographic distribution of IGS users of the CDDIS in 2011.

5 Recent Developments

The CDDIS is cooperating in the development of Geodetic Seamless Archive Centers (GSAC) with colleagues at UNAVCO and SIO. The activity will provide web services to facilitate data discovery within and across participating archives. A prototype implementation of these GSAC web services at the CDDIS is under development and should be operational in mid-2012. In addition, the CDDIS is currently implementing modifications to the metadata extracted from incoming data and product files pushed to its archive. These enhancements will facilitate cross discipline data discovery by providing information about CDDIS archive holdings to other data portals such as Earth Observing System (EOS) Clearinghouse (ECHO) and integration into the Global Geodetic Observing System (GGOS) portal.

6 Publications

The CDDIS staff attended several conferences during 2011 and presented papers on or conducted demos of their activities within the IGS, including:

Noll, C., N. Pollack, P. Michael. Improvements in Space Geodesy Data Discovery at the CDDIS. Abstract IN41B-1410 presented at *2011 Fall Meeting, AGU*, San Francisco, CA, 05-09 Dec., 2011

Electronic versions of this poster and other publications can be accessed through the CDDIS on-line documentation page on the web at URL <http://cddis.gsfc.nasa.gov/reports.html>.

7 Future Plans

In 2011, the CDDIS staff procured new server hardware to further enhance the capabilities of the system and ensure a robust archive environment. The new system will be fully redundant with the primary and secondary/failover system located in different buildings on the GSFC campus. Each system will utilize a distributed functionality (incoming, outgoing, processing servers) and will be configured with a local backup system as well as a full backup system located in a third building at GSFC. The archive is equipped with a 32 Tbyte RAID storage system and is scaled to accommodate future growth. The new server environment will become operational in early 2012.

The CDDIS successfully submitted a proposal to the IGS Multi-GNSS Experiment (M-GEX) call for proposals for archive and distribution of data and products. During 2012 the CDDIS will expand its data archive and distribution service to include data from participating multi-GNSS receivers, products derived from the analysis of these data, and

any required metadata for the experiment. The data will include newly available signals (e.g., Galileo, QZSS, and Compass). The CDDIS data ingest procedures will be modified to accommodate these new data sets, the majority of which will be archived in RINEX V3. This data format will require development of new software to extract metadata from incoming data files; the software package currently used for summarization and metadata extraction on RINEX V2 data, *teqc*, will not process data in RINEX V3 format.

The CDDIS is supporting the IGS Real-Time Pilot Project as a data center. During 2012, the CDDIS will implement an NTRIP Castor to transmit real-time data streams from stations to users. CDDIS will set up a dedicated server for this task. Possible future activities include capturing the streams for generation of 15-minute high-rate files for archive at the CDDIS.

8 Contact Information

To obtain more information about the CDDIS IGS archive of data and products, contact:

Ms. Carey E. Noll	Phone: (301) 614-6542
Manager, CDDIS	Fax: (301) 614-6015
Code 690.1	E-mail: Carey.Noll@nasa.gov
NASA GSFC	WWW: http://cddis.gsfc.nasa.gov
Greenbelt, MD 20771	http://cddis.nasa.gov

9 Acknowledgments

The author would once again like to thank the CDDIS contractor staff, Maurice Dube and Nathan Pollack (Science Systems and Applications, Inc./SSAI), Patrick Michael (Catholic University of America), and Lori Tyahla and Lisa Lee (Stinger Ghaffarian Technologies/SGT). The recognition and success of the CDDIS in many international programs can be directly attributed to the continued dedicated, consistent, professional, and timely support of its staff.

References

Noll, C. The Crustal Dynamics Data Information System: A resource to support scientific analysis using space geodesy. *Advances in Space Research*, 45(12):1421-1440, ISSN 0273-1177, 2010. doi: 10.1016/j.asr.2010.01.018.

Noll, C., Y. Bock, H. Habrich and A. Moore. Development of data infrastructure to support scientific analysis for the International GNSS Service. *Journal of Geodesy*, 83 (3–4):309–325, 2009 doi: 10.1007/s00190-008-0245-6.

Part IV

Working Groups, Pilot Projects

IGS Antenna Working Group

R. Schmid

Institut für Astronomische und Physikalische Geodäsie,
Technische Universität München, Germany

1 Generation of the absolute phase center model igs08.atx

On 17 April 2011 (GPS week 1632), the IGS adopted an IGS-specific realization of the ITRF2008, called IGS08, together with an updated antenna phase center model called igs08.atx. Details can be found in the IGSMAILs 6355 and 6374.

Main reasons for the update:

- scale difference of -0.94 ppb between ITRF2008 and ITRF2005 corresponding to a change of about $+12.2$ cm in the satellite antenna z -offsets
- lack of satellite-specific z -offset estimates for all satellites launched since the release of igs05.atx (affected about one quarter of the GPS constellation and more or less the complete GLONASS constellation)
- receiver antenna calibrations had not been updated since the release of igs05.atx

Main contributors:

- Martin Schmitz (Geo++ GmbH): preparation of type mean robot calibrations including GLONASS-specific correction values
- Paul Rebischung (IGN): investigation of the impact of receiver antenna calibration updates on station coordinates; compilation of IGS08
- Xavier Collilieux (IGN): compilation of GPS z -offset time series derived from reprocessed AC SINEX files
- Rolf Dach (CODE) and Florian Dilssner (ESOC): estimation of GLONASS satellite antenna corrections from combined GPS/GLONASS long-term solutions
- Ralf Schmid (TUM): coordination, estimation of mean GPS z -offsets from IGN time series, compilation of final model

Major changes of igs08.atx with respect to igs05.atx:

- satellite antenna z -offsets from igs08.atx are consistent with IGS08, whereas those from igs05.atx were approximately consistent with IGS05

- improved redundancy of satellite antenna z -offsets: GPS values contained in `igs08.atx` are based on results of 5 ACs (`igs05.atx`: 2), GLONASS values on those of 2 (`igs05.atx`: 1)
- preliminary block-specific z -offsets for satellites launched since the release of `igs05.atx` replaced by satellite-specific estimates
- z -offsets no longer trend-corrected due to improved quality of the ITRF vertical rates (ITRF2008 compared to ITRF2000)
- increased maximum nadir angle for GLONASS satellite antenna phase center variations (PCVs; 15° instead of 14°)
- availability of information on historical (GPS Block I and GLONASS) satellites
- availability of GLONASS-specific receiver antenna corrections from robot calibrations
- additional and updated robot calibrations
- conversion of relative receiver antenna corrections with updated AOAD/M_T values

2 Updates and content of the antenna phase center model

In case the satellite constellation changes or new receiver antenna calibrations become available, the absolute antenna phase center model of the IGS has to be updated. The GPS week of the release date is coded in the model name (`igs08_www.atx`). Table 1 lists 14 updates in 2011. Further details can be found in the corresponding IGSMAILs whose numbers are also given. Until GPS week 1631, `igs05.atx` was in use, on 17 April 2011, the IGS switched to `igs08.atx`.

Table 2 gives an overview of the data sets contained in the IGS phase center model. The numbers refer to `igs08_1685.atx` that was released in April 2012. For GPS and GLONASS, there are 68 and 81 file entries, respectively. These numbers are bigger than the number of actual satellites, as certain satellites were assigned with different PRN codes or almanac slots, respectively.

For Galileo, Compass and QZSS, the IGS model does not provide any information so far. On the one hand, the system providers didn't make official phase center offset values available and on the other hand, there is not enough observation data to get reliable satellite antenna offset estimates from terrestrial data. During the IGS Workshop in Olsztyn the adoption of conventional IGS offset values will be discussed.

Apart from the satellite antennas, the IGS model also contains phase center calibration values for 231 receiver antennas. 151 of them are certain combinations of an antenna and a radome, whereas the remaining 80 antenna types are not covered by a radome. As Tab. 2 shows, `igs08_1685.atx` contains, among others, 96 absolute robot calibrations and 90 converted field calibrations.

Table 1: Updates of the phase center models igs05.atx and igs08.atx in 2011.

week	date	IGSMAIL	change
igs05.atx			
1617	04-JAN-11	6324	Added R714 (R17), R722 (R14), R727 (R03) Decommission date: R715 (R14), R718 (R17), R722 (R03), R727 (R04)
1627	15-MAR-11	6365	Corrected date: G010 Added R715 (R03) Decommission date: R727 (R03)
igs08.atx			
1629	29-MAR-11	6374	first release of igs08.atx (used as of week 1632; see Sect. 1)
1633	28-APR-11	6396	Added R801 (R04)
1636	19-MAY-11	—	Added JAVRINGANT_DM JVDM NAX3G+C NONE STXS9SA7224V3.0 NONE Added APSAPS-3 NONE LEIGG02PLUS NONE LEIGS08 NONE LEIGS12 NONE TPSPG_A1+GP NONE
1639	06-JUN-11	6409	Added G035 (G01) Decommission date: G049
1643	30-JUN-11	6418	z-offset updated: R801 Added TRM59900.00 NONE TRM59900.00 SCIS
1644	14-JUL-11	6428	Decommission date: G035 (G01) Added ASH701946.2 SNOW
1645	18-JUL-11	6433	Added G063
1648	11-AUG-11	6450	Added G035 (G30) Decommission date: G030
1657	13-OCT-11	6474	Added R715 (R14), R742 (R04), R801 (R03) Decommission date: R715 (R03), R722 (R14), R801 (R04)
1664	01-DEC-11	6496	Added R744 Decommission date: R801 (R03) Added SEPCHOKE_MC NONE SEPCHOKE_MC SPKE
1666	14-DEC-11	6506	Added R745 Decommission date: R712
1667	20-DEC-11	6507	Added R746 Decommission date: R714 (R17)

Table 2: Number of data sets in `igs08_1685.atx` (released in April 2012).

<u>satellite antennas</u>	<u>number</u>
GPS	68
GLONASS	81
Galileo	0
Compass	0
QZSS	0
<u>receiver antennas</u>	<u>number</u>
ROBOT	96
FIELD	90
COPIED	31
CONVERTED	14

As the IGS Site Guidelines ask for elevation- and azimuth-dependent calibration values down to 0° elevation, 130 different antenna types (96 ROBOT + 31 COPIED + 3 CONVERTED) are currently approved for the installation at new or upgraded IGS stations. The remaining 101 types are no longer allowed, but their calibration values are still necessary for existing installations (see Sect. 3) as well as for reprocessing purposes.

3 Calibration status of the IGS network

Table 3 shows the percentage of IGS tracking stations with respect to certain calibration types. For this analysis, 441 IGS stations as contained in the file `logsum.txt` (available at <ftp://igs.org/igscb/station/general/>) on 30 May 2012 were considered. At that time, 99 different antenna/radome combinations were in use within the IGS network. The calibration status of these antenna types was assessed with respect to the phase center model `igs08_1685.atx` that was released in April 2012.

For three quarters of the IGS stations absolute robot calibration results are available comprising elevation- and azimuth-dependent PCVs down to the horizon. 8% of the stations are equipped with antenna types for which purely elevation-dependent PCVs derived from relative field calibrations have to be applied. The latter is not ideal, but also not a dramatic problem.

Really problematic are the remaining 17% of the stations. Their antennas are either covered by uncalibrated radomes, or there are subtypes of the antenna that are not properly modeled so far. The latter problem is currently known for two Javad antennas (`JPSREGANT_DD_E`, `JPSREGANT_SD_E`) and could be corrected soon. Deficiencies in the phase center modeling are especially disadvantageous at co-location sites where the absolute antenna position is important for comparisons with local tie measurements.

Table 3: Calibration status of 441 stations in the IGS network (`logsum.txt` of 30 May 2012, `igs08_1685.atx`).

absolute calibration (azimuthal corrections down to 0° elevation)	converted field calibration (purely elevation-dependent PCVs above 10° elevation)	uncalibrated radome (or unmodeled antenna subtype)
74.6%	8.2%	17.2%

In December 2009, the percentages for the three categories shown in Tab. 3 were 62%, 18% and 20%, respectively. The improvement after 2.5 years could mainly be achieved by the switch from `igs05.atx` to `igs08.atx` (see Sect. 1). However, part of the improvement is also due to the fact that old installations were upgraded or even decommissioned.

Activities of the IGS Bias and Calibration Working Group

S. Schaer

Swiss Federal Office of Topography swisstopo
Seftigenstrasse 264, CH-3084 Wabern, Switzerland
stefan.schaer@aiub.unibe.ch / stefan.schaer@swisstopo.ch

1 Introduction

The IGS Bias and Calibration Working Group (BCWG) coordinates research in the field of GNSS bias retrieval and monitoring. It defines rules for appropriate, consistent handling of biases which are crucial for a “model-mixed” GNSS receiver network and satellite constellation, respectively. At present, we consider: P1–C1, P2–C2, and P1–P2 differential code biases (DCB). Potential quarter-cycle biases between different phase observables (specifically L2P and L2C) are another issue to be dealt with. In the face of GPS and GLONASS modernization programs and upcoming GNSS, like the European Galileo and the Chinese Compass, an increasing number of types of biases is expected.

The IGS BCWG was established in 2008. More helpful information and related internet links may be found at <http://igs.org/projects/bcwg/>. The initial IGS BCWG membership is given in Tab. 1.

2 Relevant Bias and Calibration Products

2.1 P1–C1 differential code biases for the GPS constellation

This is still one of our primary bias products. Corresponding P1–C1 bias values (as shown in Fig. 1) are determined as part of CODE’s IGS clock analysis. The so-called *indirect* P1–C1 DCB estimation method was introduced by Schaer (2000). The initiation of a dedicated CODE DCB data archive could be announced at the beginning of 2001 (Schaer, 2001).

Table 1: IGS BCWG membership 2008.

Stefan Schaer (swisstopo/CODE, Switzerland), Chair
 Mahdi Alizadeh (TU Vienna, Austria)
 Shailen Desai (JPL, USA)
 Brian Donahue (EMR/NRCan, Canada)
 Peng Fang (SIO, USA)
 Yang Gao (U of Calgary, Canada)
 Gerd Gendt (GFZ, Germany)
 Christine Hackman (USNO, USA)
 Thomas A. Herring (MIT, USA)
 Robert Khachikyan (IGSCB, USA)
 Kristine M. Larson (U of Colorado, USA)
 Rodrigo Leandro (Trimble, Germany)
 Gerard Petit (BIPM, France)
 Jim Ray (NGS, USA)
 Nacho Romero (ESA/ESOC, Germany)
 Peter Steigenberger (TU Munich/PDR, Germany)
 Sonya Todorova (TU Vienna, Austria)

Ex officio:
 Chair of the Clock Products WG
 Chair of the Ionosphere WG
 Chair of the Reprocessing WG
 Chair of the GNSS WG
 IGS Analysis Coordinator
 IGS Network Coordinator
 Representative of the BIPM

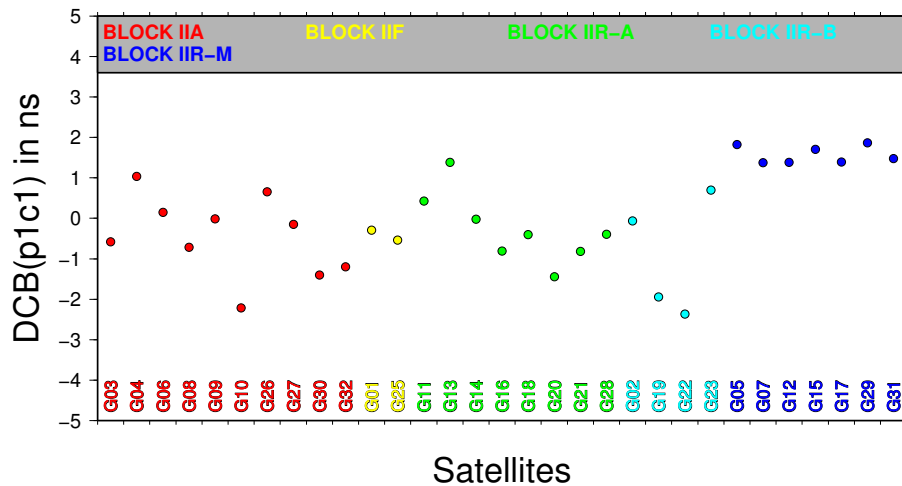

Figure 1: Monthly set of P1–C1 differential code biases for the GPS constellation, for December 2011, computed at CODE.

2.1.1 CC2NONCC RINEX converter utility

The CC2NONCC RINEX converter utility was developed by Ray (2000, 2001) in order to convert cross-correlation (CC) (or C1/P2) pseudorange data to data being consistent to P1/P2 (non-CC) data. Officially starting with data collected on 18 March 2001 (start of GPS week 1106), the CODE P1–C1 bias values were recommended for use by all IGS ACs and users of IGS clock products (Ray, 2001). We appreciate it very much that further developed and regularly updated versions of the CC2NONCC RINEX converter utility were made available by Romero (2008, 2011) from ESA/ESOC.

2.1.2 Verification of receiver tracking class

The knowledge of — to which receiver tracking class a particular receiver model may be attributed to — is of fundamental importance for consistent P1–C1 DCB correction. A reliable method to verify the receiver tracking class on the basis of RINEX data samples was developed and widely tested by Schaer (2002). At present, we use to distinguish between three classes (for GPS): C1/X2, P1/P2, C1/P2. Receiver tables, such as that one used for the analyses at CODE and that one dedicated to CC2NONCC, are updated with new receiver types (as they appear in the IGS, EUREF, and other prominent receiver networks).

2.2 P1–P2 differential code biases for GPS and GLONASS

P1–P2 DCB information, a conventional by-product of the IGS ionosphere analysis (and therefore included in IONEX results), is compared and combined as part of routine IGS

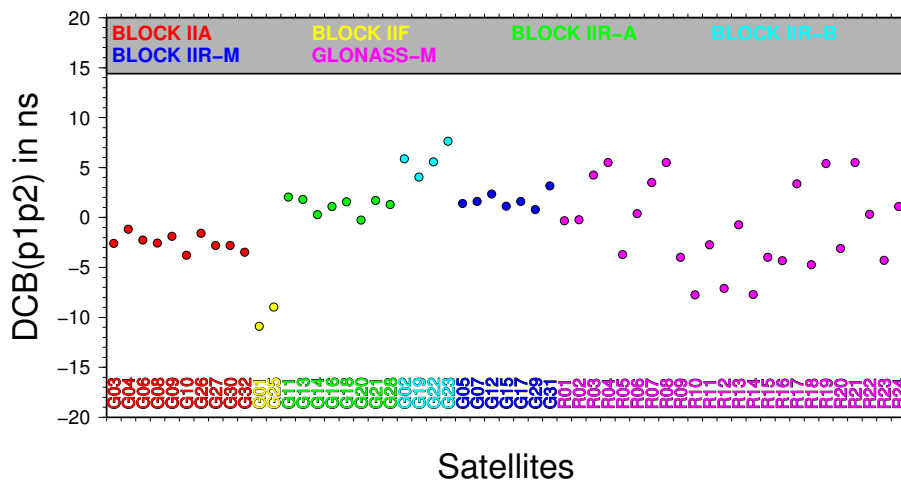

Figure 2: Monthly set of P1–P2 differential code biases for the GPS and GLONASS constellation, for December 2011, computed at CODE.

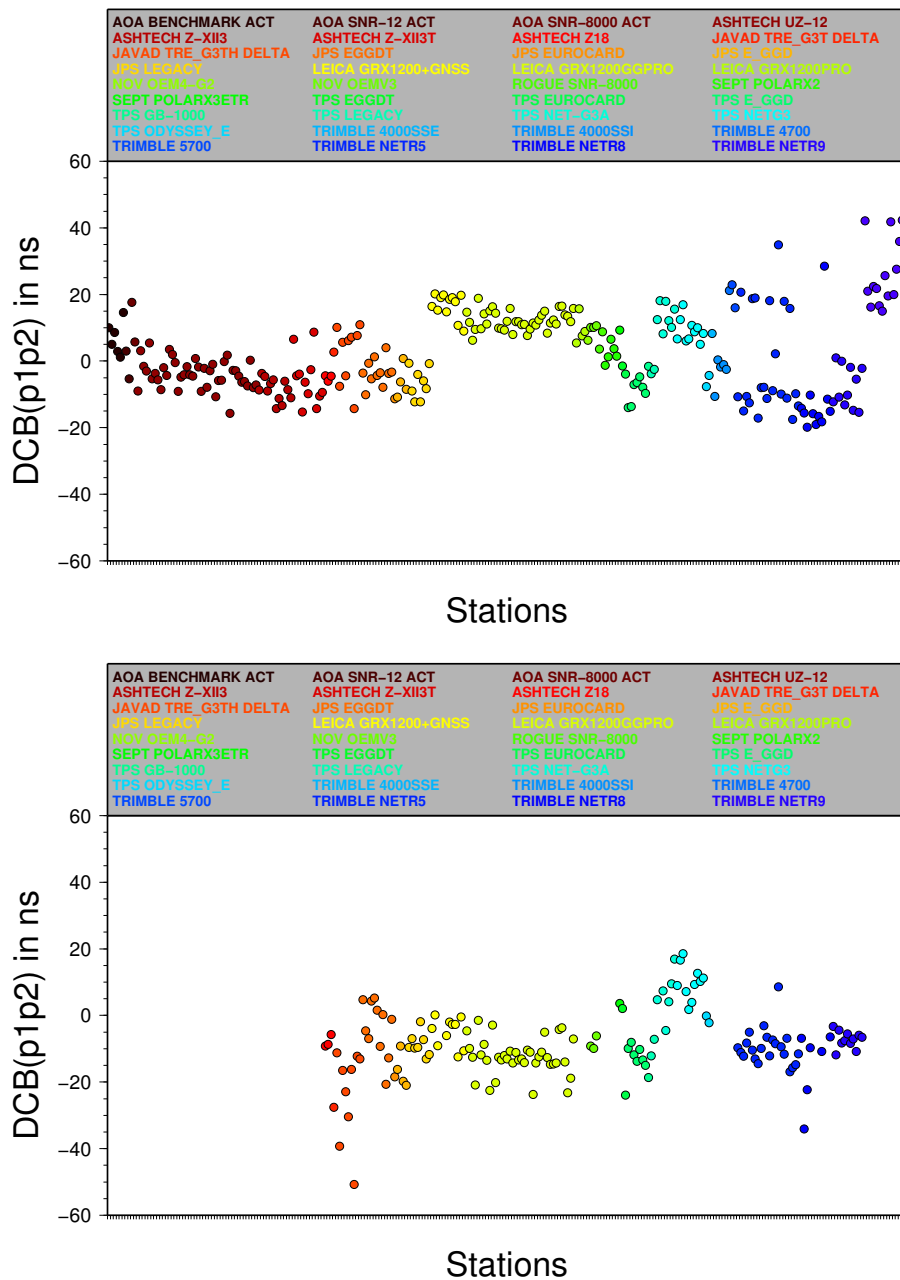

Figure 3: Monthly set of P1–P2 differential code biases for the GPS (top) and GLONASS (bottom) receiver components, for December 2011, computed at CODE.

ionosphere WG activities. P1–P2 DCB results as produced by the CODE AC with respect to *GLONASS* still seem to be unique within the IGS analysis community. Corresponding (ionosphere-dependent) GNSS DCB results are shown in Fig. 2 and Fig. 3.

2.3 P1–C1 and P2–C2 differential code biases for GPS and GLONASS

A new tool was developed for direct GNSS DCB estimation for P1–C1 and P2–C2 values based on RINEX data (Schaer and Dach, 2010). The main features of this tool are:

- P1–C1 and P2–C2 observation differences are analyzed file by file (typically station by station for a particular day) and stored for subsequent least-squares combination, which can be recalled for: selected receiver types, selected receiver groups, or ultimately for all considered receivers/stations (overall combination).
- Sophisticated outlier detection scheme using quantities responding to the interquartile range ($IQR = Q_{0.75} - Q_{0.25}$) is applied. Consequently, just one scalar quantity has to be selected to cope with observation data with most various noise levels and characteristics, respectively
- Least-squares combination is performed with an outlier detection scheme concerning station-specific, or file-specific DCB determinations.

This tool has been considerably further developed to be able to cope with all possible RINEX data scenarios, specifically with historical data, where we got confronted with numerous problems and anomalies.

A complete GPS/GLONASS DCB reprocessing was carried out at CODE on the basis of 1990–2011 RINEX data. The outcome of this P1–C1 and P2–C2 DCB reprocessing effort is: daily sets, a multitude of daily subsets, and in addition monthly sets. Analysis and combination of these remarkably long time series must be seen as a medium-term (or long-term) goal. Examples for P1–C1 and P2–C2 monthly results (as computed for December 2011) are shown in Figures 4, 5, 6. Fig. 7 includes four subfigures showing the time evolution of the contributing number of GNSS satellites and corresponding receiver components for the 1990–2011 DCB reprocessing.

2.4 GLONASS ambiguity resolution and associated SD biases relevant for GLONASS ambiguity initialization

As documented in the CODE analysis summary of GPS week 1625 (Schaer et al., 2011a), ambiguity resolution was extended to GLONASS for three resolution strategies. CODE's extended GNSS ambiguity resolution scheme as performed in an operational mode may be summarized as follows:

- Up to 6000 km (3000 km in a first POD step): Melbourne–Wübbena widelane and subsequent narrowlane ambiguity resolution (AR) are restricted to GPS only.
- Up to 2000 km: Quasi-Ionosphere-Free (QIF) L1/L2 AR for GPS and in addition for GLONASS DD ambiguities with the same frequency channel numbers.

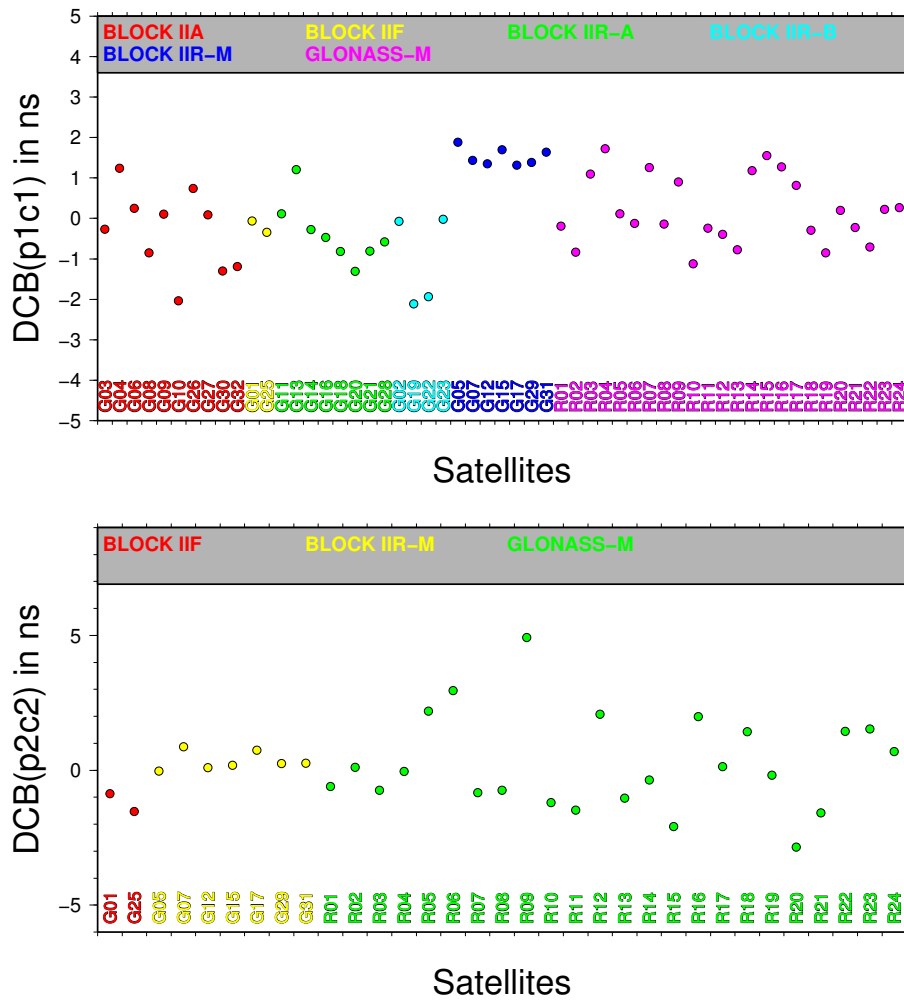

Figure 4: Monthly set of P1–C1 (top) and P2–C2 (bottom) differential code biases for the GPS and GLONASS constellation, for December 2011, computed at CODE.

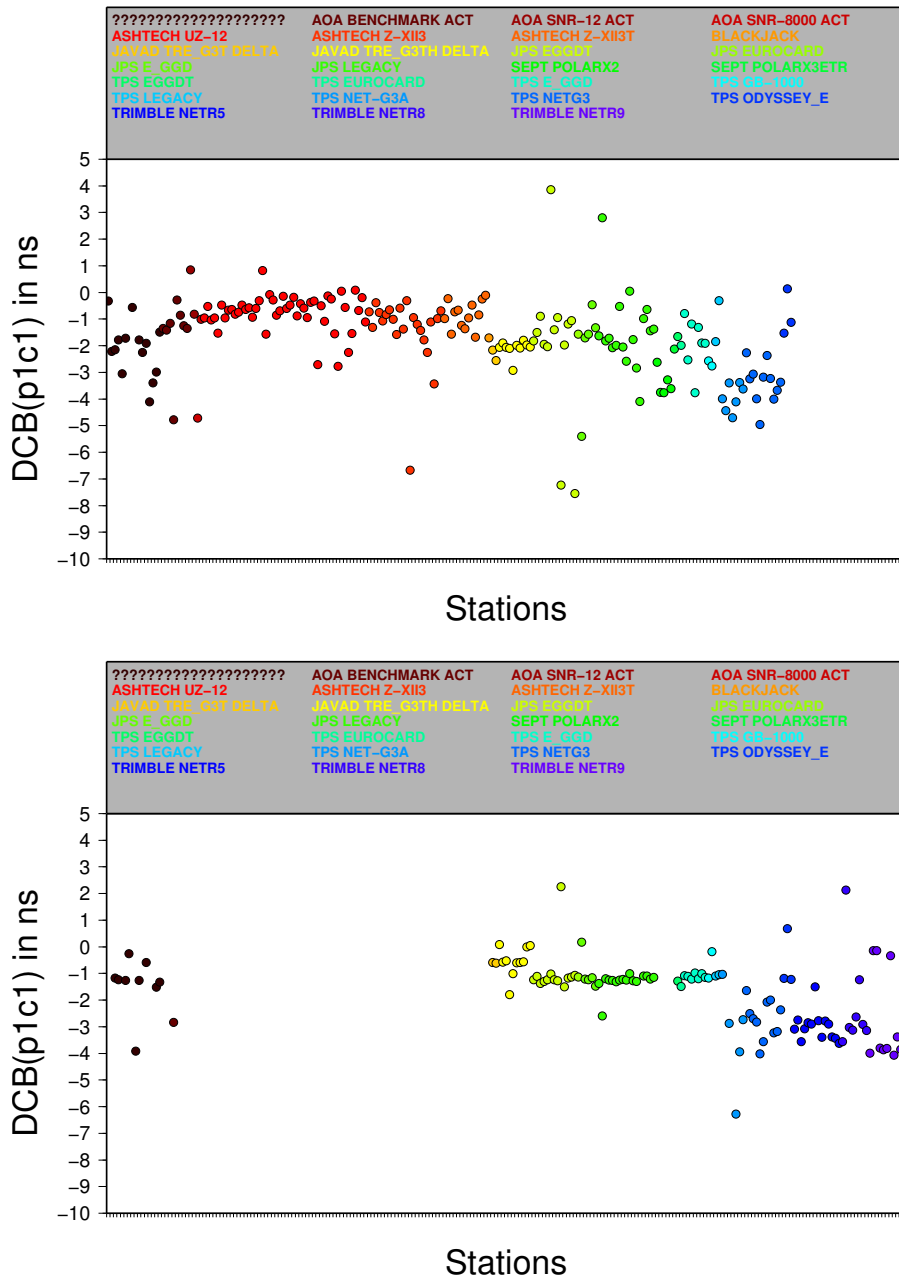

Figure 5: Monthly set of P1–C1 differential code biases for the GPS (top) and GLONASS (bottom) receiver components, for December 2011, computed at CODE.

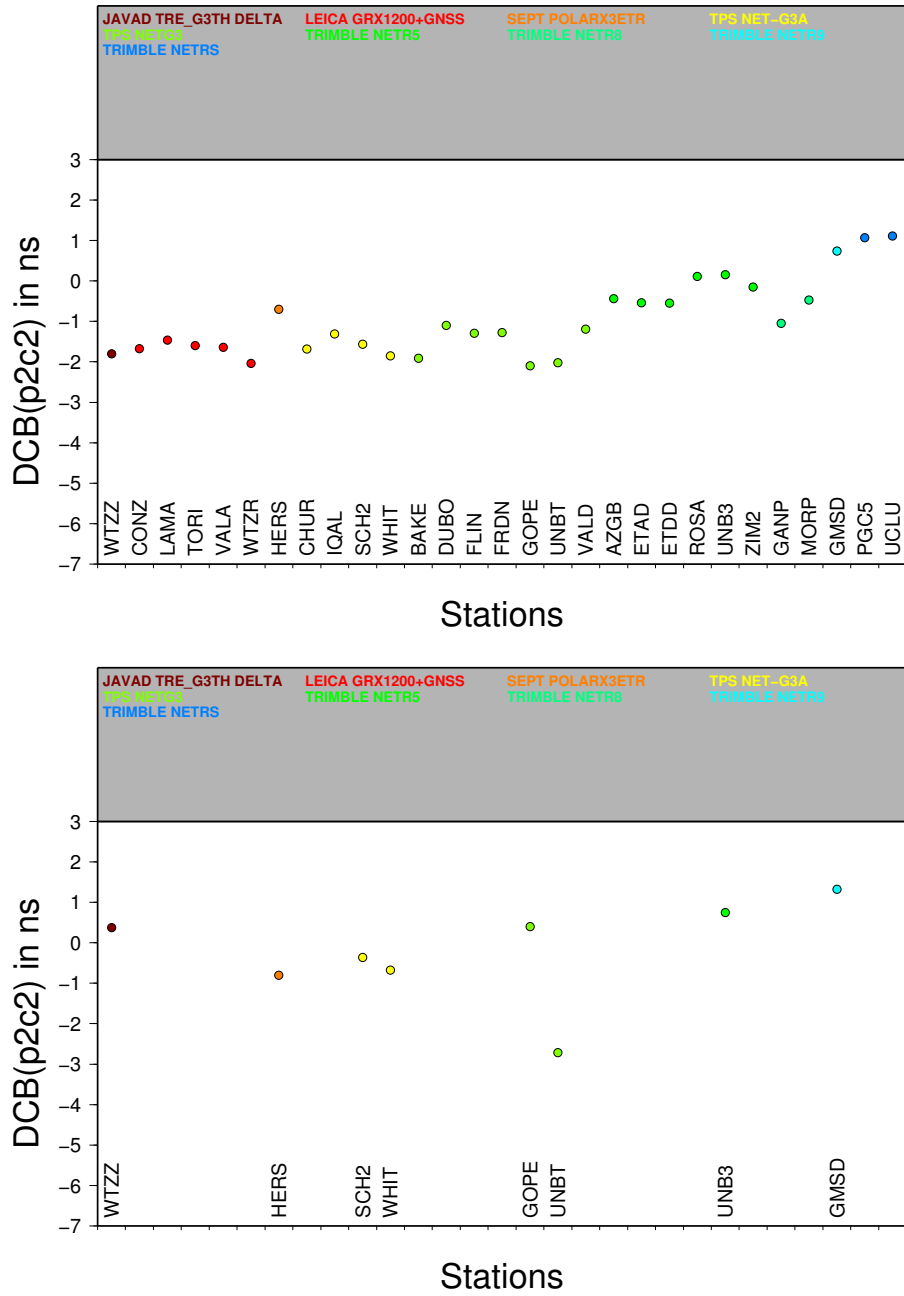

Figure 6: Monthly set of P2–C2 differential code biases for the GPS (top) and GLONASS (bottom) receiver components, for December 2011, computed at CODE.

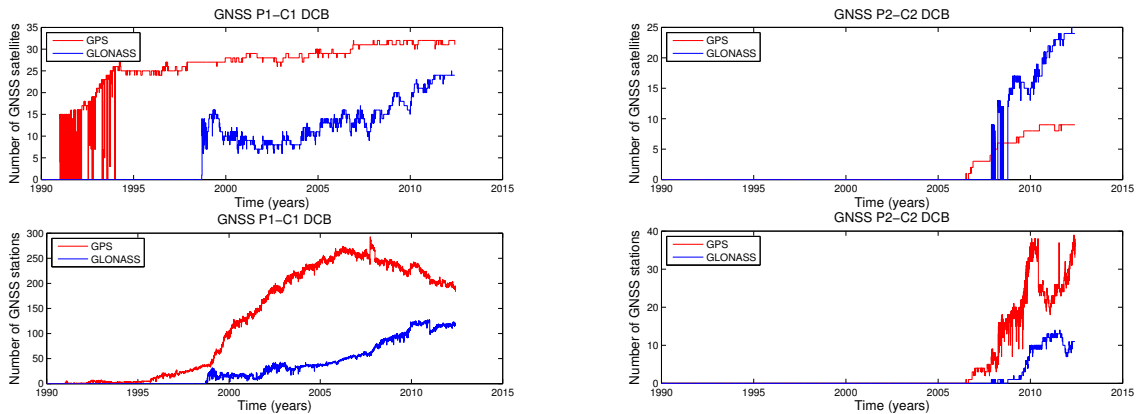

Figure 7: Time evolution of contributing number of GPS and GLONASS satellites (top) and corresponding receiver components (bottom), for P1–C1 (left) and P2–C2 (right) GNSS DCB reprocessing, carried out at CODE on the basis of 1990–2011 RINEX data.

- Up to 200 km: Phase-based widelane AR for GPS and GLONASS, including retrieval of GLONASS SD ambiguity initialization biases; narrowlane AR for GPS and GLONASS, considering the previously retrieved SD bias values.
- Up to 20 km: Direct L1/L2 AR for GPS and GLONASS, including retrieval of GLONASS SD ambiguity initialization biases. Optionally, the widelane-based SD bias retrievals could be considered as a priori bias information.

We consider the following rules essential for successful GLONASS ambiguity fixing:

- GNSS ambiguity parameters are generally treated at SD level.
- GNSS ambiguities are resolved at DD level (differences of SD ambiguities).
- The SD ambiguity parameters directly respond to (always) existing SD (ambiguity initialization) biases. Implicitly, they act as SD bias calibration parameters and thus may absorb present SD biases in the LS parameter adjustment.
- The initial singularity concerning all involved SD ambiguity parameters has to be eliminated by imposing loose constraints on these parameters. After fixing a first GLONASS DD ambiguity for a pair with unequal frequency channel numbers, SD ambiguity parameters become determinable.
- There are absolutely no extra bias parameters at DD level, apart from (unresolved) intersystem ambiguity parameters (see next item).
- GPS–GLONASS intersystem ambiguities are generally treated *unresolved*.
- A *self-calibrating* AR procedure (as used at CODE) is definitively indispensable.
- Our AR principles are also applicable to rapid static positioning using LAMBDA methods generalized for multi-GNSS (Schaer et al., 2009).

Table 2: Compilation of a long-term averaged set of GPS code biases (conforming to receiver clock synchronization) playing a decisive role for GLONASS ambiguity initialization at SD level.

Receiver type	SD bias	RMS error (ns)
ASHTECH Z18	+22.120	2.268
JAVAD TRE_G3TH DELTA	+218.901	0.675
JPS EGGDT	+58.271	0.606
JPS E_GGD	+128.505	0.565
JPS LEGACY	+111.921	0.609
LEICA GRX1200+GNSS	-269.900	0.753
LEICA GRX1200GGPRO	-242.546	0.484
NOV OEMV3	-247.286	0.516
SEPT POLARX3ETR	-501.984	0.533
TPS EGGDT	+70.275	0.726
TPS EUROCARD	+155.776	0.652
TPS E_GGD	+121.529	0.868
TPS LEGACY	+92.682	0.517
TPS NETG3	+52.682	0.507
TPS ODYSSEY_E	+57.586	0.611
TRIMBLE NETR5	+96.551	0.515
TRIMBLE NETR8	+74.919	0.908

Last but not least, an additionally implemented BPE processing step dedicated to (base-line-wise) verification of all fixed GNSS ambiguities for the ionosphere-free LC (and other LCs, if indicated) turned out to be utmost valuable for detection of any anomalies, such as unexpectedly occurring GPS quarter-cycle biases (see also Section 2.9).

Tab. 2 contains a compilation of a long-term averaged set of GPS code biases relevant for GLONASS ambiguity initialization at SD level, namely for IGS-representative GNSS receiver types. It should be emphasized that the determined SD biases are interpreted as differential code biases, DCB. They are finally applied (as differential phase biases, DPB) to SD phase measurements. That implies that this type of bias must be addressed as *differential code-phase bias (DCPB)*. For interpretation (and eventually the use) of the bias values given in Tab. 2, it is important to add that *GPS* code data is used for GNSS receiver clock synchronization.

2.5 GLONASS–GPS station-specific intersystem translation parameters as introduced at CODE

Since GPS week 1619, an extra set of (3+1) parameters is set up for each GLONASS observing station to characterize

- a GLONASS–GPS receiver antenna offset vector and
- a GLONASS–GPS ZPD troposphere bias.

Starting with GPS week 1625, these GLONASS–GPS bias parameters (4 for each GNSS station) are determined on a weekly basis and subsequently used for generation of our daily IGS analysis results (Schaer et al., 2011a). The most decisive analysis characteristics in terms of these new extra bias parameters are:

- The datum definition used for the GLONASS–GPS receiver antenna offset vectors is similar to that used for station coordinates: no–net translation and no–net rotation conditions with respect to all GLONASS observing stations are imposed.
- GLONASS–GPS ZPD troposphere biases are generally treated *unconstrained*.
- Our weekly SINEX contribution implicitly includes these GLONASS–GPS bias parameters (4 for each GNSS station).

Fig. 8 shows the time evolution of the mean GLONASS–GPS troposphere ZPD bias as extracted for CODE IGS weekly results (for GPS weeks 1619–1635). The so far very significant mean GLONASS–GPS troposphere bias did vanish completely in coincidence with the IGS ANTEX model switch from IGS05 to IGS08 (stipulated to be adopted starting with GPS week 1633). The primary reason for the clearly visible model improvement may most likely be attributed to the update concerning antenna phase center Z –offsets for the GLONASS constellation.

The ultimate consequences of the newly accomplished, rather trendsetting developments on GNSS–based ITRF and thus on SINEX (potentially in addition on ANTEX) are not yet clear to us. We believe that consideration of station–specific intersystem translation parameters for each additionally observed GNSS is a logical step and will become standard for highest–precision, “as–consistent–as–possible” multi–GNSS analysis (in particular for consistency monitoring purposes, as demonstrated in Fig. 8). For more details, the interested reader is referred to (Schaer and Meindl, 2011).

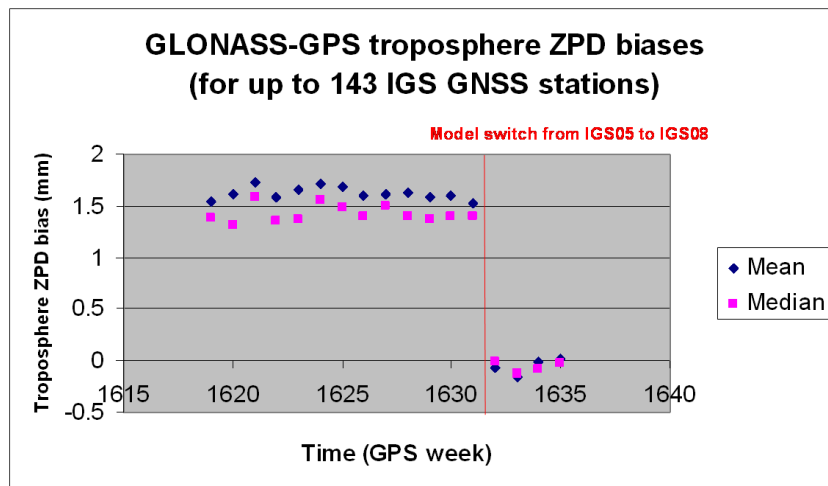

Figure 8: Time evolution of mean GLONASS–GPS troposphere ZPD bias as extracted for CODE IGS weekly results, for GPS weeks 1619–1635.

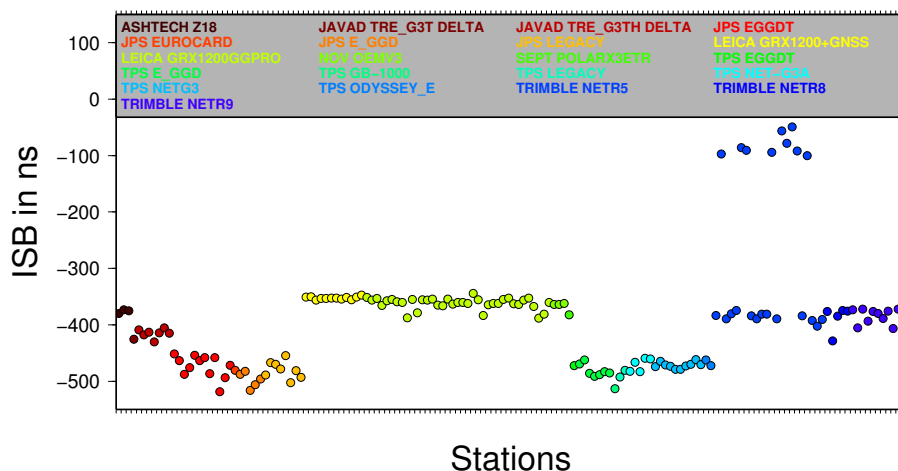

Figure 9: GLONASS–GPS intersystem clock/time biases/differences as computed for a set of IGS stations, for 12 January 2012.

2.6 GPS–GLONASS intersystem time differences

Fig. 9 shows corresponding intersystem time/clock differences/biases as computed for a set of IGS stations. The computation was done using GPS and GLONASS broadcast clock information. From Fig. 9, it is obvious that the size of the computed differences/biases does depend on the receiver type and, in some cases, even on the receiver firmware. Moreover, the spread of the intersystem time differences clearly indicates that absolute determination of the GPS–GLONASS system time difference is impossible. Absolute receiver calibrations would be actually desirable for this purpose.

2.7 GLONASS interfrequency code biases

For computation of precise GLONASS clock offsets, it is common to set up differential code bias (DCB) parameters for each GLONASS satellite (or alternatively for each frequency channel number) and for each involved GLONASS tracking station (Dach et al., 2010). The same is by the way also valid for GLONASS–based PPP (at least when relying on GLONASS code data). It is intended to make detailed comparisons of AC–specific sets of GLONASS interfrequency code biases for the first time for the planned *IGS Workshop on GNSS Biases 2012* (see Section 4).

2.8 GLONASS–GPS intersystem phase bias variability

The stability of phase biases among all considered GNSS at a level of the phase measurement noise would be a basic requirement for our multi–GNSS analysis. However,

we could show that the GLONASS–GPS intersystem phase bias variability may reach, in extreme cases, a level which should no longer remain neglected (Schaer et al., 2007). Further investigations are needed in this area in order to exploit the full potential of “as-consistent-as-possible” multi-GNSS analysis.

2.9 GPS quarter-cycle phase bias issue

L2(C) phases (for GPS Block IIR–M/IIF satellites) may reveal quarter-cycle biases with respect to L2(P) (for previous, “non–C2” GPS generations), particularly in case of: Javad, Leica, NovAtel. GPS quarter-cycle phase biases are a serious issue, even when analyzing latest IGS data samples (Schaer and Meindl, 2012). It is quite evident that the list of potentially affected receivers has to be completed. A consequence of this (in fact RINEX2–inflicted) bias issue is that ambiguity resolution may suffer considerably as soon as a receiver type belonging to the affected receiver group becomes involved. To be more specific, ambiguity differences between modernized GPS satellites (Block IIR–M and IIF) and older generations may be fixed occasionally to constants biased by ± 0.25 cycle. It should be mentioned that the CODE AC is in a good position for detection of any kind of potential GNSS phase biases due to the (intended) circumstance that a significant number of shortest (≤ 20 km) baselines is considered for direct ambiguity resolution of the original GPS/GLONASS L1/L2 phase integers (see also Section 2.4).

3 Redesign of GNSS DCB combination/estimation processing environment at CODE

The outdated (reliably working) processing environment used at CODE for

- regular GNSS DCB combination,
- ionosphere prediction and monitoring,
- generation of Klobuchar–style ionosphere coefficients (on the basis of various CODE IONEX products),
- associated visualization, web update, and many other DCB/ionosphere related tasks

has been completely revised and fully redesigned in 2011 (and 2012). A coordinated effort was made in 2011 to upgrade all involved extra Bernese GNSS Software modules from development version 4.3 to 5.1. Whenever possible, the upgraded modules were further generalized (also in terms of multi-GNSS). A dedicated BPE (Bernese Processing Engine) procedure was developed, also including the recently developed direct GNSS DCB estimation capabilities as introduced in Section 2.3. Completion of this redesign work may be expected in 2012.

4 IGS Workshop on GNSS Biases 2012

A *Workshop on GNSS Biases* will be organized by the Astronomical Institute of the University of Bern (AIUB) on behalf of the IGS Bias and Calibration WG:

Date: 18–19 January 2012

Place: University of Bern, Hochschulstrasse 4, CH–3012 Bern

This workshop is foreseen as a roundtable conference with a limited number of participants (max. 35). We will consider this mostly an invitation-only meeting. Current issues (concerning GPS and GLONASS) as well as issues related to new signals and further GNSS shall be discussed. This shall become a forum for the IGS ACs/BCWG and representatives from relevant GNSS receiver manufacturers and RTCM/RINEX side.

Detailed information is available at: <http://www.biasws2012.unibe.ch>

Note that an RTCM SC–104 Meeting is scheduled for 16–17 January 2012 at the same location.

5 IGS–BCWG Mailing List

The IGS–BCWG (Bias and Calibration Working Group) mailing list has been created in 2011 (see <http://igscb.jpl.nasa.gov/mailman/listinfo>).

It is our intention to open the newly created IGS–BCWG discussion forum to a broader focused group of experts with experience and strong interests (including the RTCM/RINEX community and key experts from GNSS receiver manufacturers). Therefore, we propose that all interested persons (interested in the planned *bias workshop 2012*, or just interested in tracking the discussions) shall register to:

<http://igscb.jpl.nasa.gov/mailman/listinfo/igs-bcwg>

Additional notes:

- BCWG members were subscribed automatically. The initial group member list did include 29 addresses.
- Membership requires approval from the moderator.
- Archiving is enabled. Only list members may view the archive.
- The e-mail address to the group is: igs-bcwg@igscb.jpl.nasa.gov

References

Dach, R., S. Schaer, M. Meindl, S. Lutz, E. Orliac, and H. Bock (2010). Biases in GNSS Data Processing. *AGU Fall Meeting*, San Francisco, USA, December 13–17, 2010.

- Dach, R., M. Meindl, S. Schaer, S. Lutz, R. Schmid, and G. Beutler (2011). System dependence of GNSS receiver antenna calibrations. *EGU General Assembly*, Vienna, Austria, April 3-8, 2011.
- Ray, J. (2000). IGS MAIL #2744: New pseudorange bias convention. <http://igsb.jpl.nasa.gov/pipermail/igsmail/2000/002818.html>.
- Ray, J. (2001). IGSMAIL #3220: Updated <P1-C1> biases and cc2noncc. <http://igsb.jpl.nasa.gov/pipermail/igsmail/2001/003294.html>.
- Romero, I. (2008). IGSMAIL #5778: A new CC2NONCC. <http://igsb.jpl.nasa.gov/pipermail/igsmail/2008/005849.html>.
- Romero, I. (2011). IGSMAIL #6398: CC2NONCC important software update. <http://igsb.jpl.nasa.gov/pipermail/igsmail/2011/006390.html>.
- Schaer, S. (2000). IGSMAIL #2827: Monitoring (P1-C1) code biases. <http://igsb.jpl.nasa.gov/pipermail/igsmail/2000/002901.html>.
- Schaer, S. (2001). IGSMAIL #3212: CODE DCB data archive initiated. <http://igsb.jpl.nasa.gov/pipermail/igsmail/2001/003286.html>.
- Schaer, S. (2002). IGSMAIL #3887: TRIMBLE 4700. <http://igsb.jpl.nasa.gov/pipermail/igsmail/2002/003961.html>.
- Schaer, S and M. Meindl. (2012) IGSMAIL #6583: GPS quarter-cycle biases. <http://igsb.jpl.nasa.gov/pipermail/igsmail/2012/006575.html>.
- Schaer, S., E. Brockmann, and D. Ineichen (2007). Inclusion of GLONASS for EPN Analysis at CODE/swisstopo. In: Torres, J.A. and H. Hornik (Eds): *Subcommission for the European Reference Frame (EUREF)*, London, 2007. EUREF Publication No. 17, pp. 86–94.
- Schaer, S. (2008). Differential code biases (DCB) in GNSS analysis. *IGS Workshop*, Miami Beach, FL, USA, June 2–6, 2008.
- Schaer, S, E. Brockmann, M. Meindl, and G. Beutler (2009). Rapid Static Positioning Using GPS and GLONASS. In: Ihde, J. and H. Hornik (Eds): *Subcommission for the European Reference Frame (EUREF)*, Firenze, 2009.
- Schaer, S. and R. Dach (2010). Biases in GNSS Analysis. *IGS Workshop*, Newcastle upon Tyne, England, 28 June – 2 July, 2010.
- Schaer, S. et al. (2011a). IGSREPORT #19560: Wk 1625 COD Analysis Report. <http://igsb.jpl.nasa.gov/pipermail/igsreport/2011-March/019573.html>.
- Schaer, S. and M. Meindl (2011). Consideration of Station-Specific Intersystem Translation Parameters at CODE. *EUREF Symposium*, Chisinau, May 25–28, 2011.

Schaer, S., H. Bock, R. Dach, S. Lutz, M. Meindl, E. Orliac, D. Thaller (2011b). *Contributions to the IGS*, chapter Commission 1:Reference Frames, pages 1–2. Swiss National Report on the Geodetic Activities in the years 2007–2011 to the XXV General Assembly of the IUGG, Melbourne, Australia, 28 June — 7 July 2011. Swiss Geodetic Commission, 2011.

Schaer, S. and R. Dach (2011). *GNSS Data Calibration Parameters*, chapter Commission 1:Reference Frames, pages 7–9. Swiss National Report on the Geodetic Activities in the years 2007–2011 to the XXV General Assembly of the IUGG, Melbourne, Australia, 28 June — 7 July 2011. Swiss Geodetic Commission, 2011.

Schaer, S. and M. Meindl (2011). *Multi-GNSS Ambiguity Resolution Algorithms*, chapter Commission 4: Positioning and Applications, pages 95–96. Swiss National Report on the Geodetic Activities in the years 2007–2011 to the XXV General Assembly of the IUGG, Melbourne, Australia, 28 June — 7 July 2011. Swiss Geodetic Commission, 2011.

IGS Data Center Working Group 2011

C. Noll

NASA Goddard Space Flight Center, Code 690.1
Greenbelt, MD 20771 USA
Carey.Noll@nasa.gov

1 Introduction

The IGS Data Center Working Group (DCWG) was established in 2002. The DCWG tackles many of the problems facing the IGS data centers as well as develops new ideas to aid users both internal and external to the IGS. The direction of the IGS has changed since its start in 1992 and many new working groups, projects, data sets, and products have been created and incorporated into the service since that time. The DCWG was formed to revisit the requirements of data centers within the IGS and to address issues relevant to effective operation of all IGS data centers, operational, regional, and global.

2 Recent Activities

A Data Center Working Group meeting was held during IGS 2010 Workshop. The viability of the group was confirmed. Recommendations were made resulting from presentations during workshop and meeting discussion (see Future Planning below). The WG supported the IGS Infrastructure Committee and began implementation of daily data status summary files at all GDCs. The file summarizes the daily data holdings and extracts key metadata and data quality information from all files. Further discussions have been made to improve and generalize software. The WG also coordinated product archival with other data centers, including working with the IGS ACC in the final archiving of IGS repro1 products with the IGS Global Data Centers. The WG began coordination on data center infrastructure support for upcoming IGS M-GEX activity.

3 Future Plans

In 2012–2013, the DCWG will continue to work on addressing recommendations from the IGS 2008 and 2010 Workshops. Topics the WG hopes to address follow.

Support of the IGS Infrastructure Committee: A major focus of the DCWG for the next two years will be to support the IC in its various activities to coordinate the resolution of issues related to the IGS components. These activities will address recommendations from recent IGS Workshops including assessment and monitoring of station performance and data quality, generating metrics on these data.

Data center harmonization: The working group will consider methodologies for ensuring key data sets are available at all GDCs. Following recommendations from the IGS 2010 Workshop, the WG will coordinate with GDCs to ensure all GDCs archive data from all IGS stations as identified on the IGS network website; ODCs push data, and any subsequent resubmissions, from their stations to ALL GDCs and ODCs issues advisory for ALL resubmissions.

Compression: As per a recommendation from the IGS 2010 Workshop, the DCWG will develop a plan for the introduction of a new compression scheme into the IGS infrastructure by evaluating tests of available tools, surveying the IGS infrastructure, making a recommendation on a new IGS compression scheme, and coordinating recommendations with the IC to develop implementation schedule.

Real-time data streams/high-rate GNSS data handling: Another recommendation from the 2008 IGS Workshop concerned transfer of high-rate data to data centers via traditional file transfer or through accumulation of real-time data streams. IGS data centers must ensure that files generated from these streams are sufficiently reliable. The DCs must also coordinate to ensure consistent copies of high-rate files are archived. This recommendation was updated in the 2010 IGS Workshop to include definition and development of

1. tool for comparison of RINEX files from various construction approaches,
2. minimum requirements for acceptance of an accumulated data stream of observations as a RINEX file in IGS data archives,
3. mandatory/optional observation types to be included,
4. procedures to fill the gaps in the case data streams have been interrupted.

This activity should be coordinated with the RTPP, ACs, DCs, and IC.

M-GEX: As the IGS Multi-GNSS Experiment begins, the DCWG will advise and coordinate archival of the experiment's data from other GNSS and products derived from these data sets.

The DCWG will meet during the 2012 IGS Workshop in Olsztyn, Poland.

4 Publications

The DCWG gave several presentations in the last two years, including:

- Noll, C., M. Schmidt, H. Habrich, and B. Garayt. The Evolution of the IGS Flow of Data (and Products and Information) and Steps Ahead. *IGS Analysis Workshop*, Newcastle, UK, June 2010.
- Noll, C., M. Schmidt, B. Michael, Y. Lu. Updates to the IGS Data Center Infrastructure. Abstract G11B-0642 presented at *2010 Fall Meeting, AGU*, San Francisco, Calif., 13–17 Dec., 2010.

Electronic versions of this poster and other publications can be accessed through the CDDIS on-line documentation page on the web at URL <http://cddis.gsfc.nasa.gov/reports.html>.

5 Membership

- Carey Noll (NASA GSFC/USA), Chair
- Yehuda Bock (SIO/USA)
- Ludwig Combrinck (HRAO/South Africa)
- Bruno Garayt (IGN/France)
- Paul Jamason (SIO/USA)
- Heinz Habrich (BKG/Germany)
- Michael Moore (GA/Australia) (tbc)
- Ruth Neilan (JPL/USA), ex-officio
- Markus Ramatschi (GFZ/Germany)
- Jim Ray (NOAA/USA), ex-officio
- Nacho Romero (ESA/Germany)
- Mike Schmidt (NRCan/Canada)
- Giovanni Sella (NOAA/USA)
- Grigory Steblov (RDAAC/Russia)
- Dave Stowers (JPL/USA)

IGS GNSS Working Group

R. Weber

Institute of Geodesy and Geophysics,
University of Technology Vienna, Austria
Gusshausstrasse 27–29, A–1040 Vienna;
E-mail: robert.weber@tuwien.ac.at

According to the recommendations decided at the IGS Workshop 2010 in Newcastle the IGS GNSS Working Group (WG) was refocused in 2011. The WG shall concentrate on recent developments of GPS, GLONASS, Galileo, Compass/Beidou, QZSS (and to the extent necessary also overlay systems) and establish on the one hand suitable interfaces to organizations operating GNSS-systems or multi-GNSS networks and to receiver manufacturers on the other. In this context the WG shall set up and conduct a multi-GNSS tracking experiment (MGEX) based on GNSS receivers capable of tracking most of the new signals and systems.

The new directions are reflected by the WG-Charter adopted recently by the IGS Governing Board. Below an excerpt of this document is provided:

With the imminent introduction of new civilian signals in GPS, the modernization of GLONASS as well as the development of other Global Navigation Satellite Systems like Galileo and Compass, and further regional overlay systems the IGS is facing a changing landscape. It is essential that the implications for the service are fully analysed and that the new factors affecting its operations are duly taken into account in IGS strategic planning.

Even all currently active constellations comprise a gradually changing mix of satellites transmitting the standard and the new signals. New receiver types will have to be introduced into the network and there will be new requirements on software for handling the data in the Analysis Centres. The long lasting IGS experience of introducing GLONASS in all chains of observation, data transfer and analysis will assist in minimizing the impact of these further changes on the service operations and in integrating the new features into the IGS infrastructure to the advantage of users of the IGS products.

Thus, in order to prepare for upcoming new signals and systems it is essential that IGS gathers experience with tracking the new signals and systems, new receiver and antenna types, inter system biases, and analysis of the new signals. To facilitate these studies the WG sets up and conducts a multi-GNSS tracking experiment (MGEX) based on GNSS

receivers capable of tracking most of the new signals and systems, including experimental satellites. In addition suitable interfaces to organizations already operating or planning to setup multi-GNSS tracking networks have to be established to ensure data availability to IGS components.

Activities in 2011

In 2011 the membership of GNSS-WG has changed to a certain extent. As of end 2011 the Working Group consisted of 15 scientists well known in the GNSS community. For a more detailed information see <http://www.igs.org/projects/gnss/index.html>.

The major activity was the preparation of the Call for Participation of the IGS demonstration campaign MGEX focusing on tracking new signals and constellations by deployed multi GNSS receivers (hard- and software receivers). The IGS MGEX is coordinated by an Experiment Organizing Committee. This Committee is appointed by the IGS GB for the duration of the experiment and will then be dissolved. Further activities are coordinated by the IGS GNSS Working Group. Further support is sought after from the IGS Working Groups which are deeply involved in the exploration and use of the new signals, e.g. the Antenna WG, the Bias and Calibration WG and the RINEX WG. Furthermore MGEX will be supported by the IGS Infrastructure Committee.

The main purpose of IGS MGEX campaign is to conduct a global multi-GNSS signals tracking experiment in parallel to the regular IGS operations, to focus on tracking the newly available GNSS signals. This includes all signals from the modernized satellites of the GPS and GLONASS systems, as well as for the first time in IGS operations, all available or applicable signals of the Compass/BeiDou, Galileo and QZSS systems and any space-based augmentation system (SBAS) of interest. In first instance the experiment is focused on collecting and making publicly available observation data suitable for post-processing and engineering analysis. However, Real-Time (RT) data flow from participating individual sites or organizations contributing via tracking data exchange with this experiment is also very welcome, and will be coordinated by the IGS RT Working Group <http://www.rtigs.net/>.

The IGS M-GEX Call for Participation(CfP) has been issued end of August 2011 via IGSMail (Hugentobler and Neilan, 2011). The campaign was also announced during the 3rd Int. Colloquium on Galileo Science Aspects in Copenhagen (Weber et al., 2011).

The CfP was seeking participation through the following components:

- Multi-GNSS Observing sites
- Multi-GNSS Data Centers
- Multi-GNSS Experiment Analysis Centers and/or Engineering Analysis Centers
- Multi-GNSS Collaborating Organisations and Networks

Concerning receivers only geodetic-type receivers (capable of collecting pseudorange and carrier phase observations) should be used. Receivers should be able to track GPS or GPS+GLONASS signals and in parallel signals of further systems such as Galileo (GIOVE/IOV), Compass/BeiDou and, if possible QZSS, on at least two frequencies. The goal is to track as many signals as possible with a clear focus on GNSS but tracking data can include also SBAS signals. It is essential to note that the IGS MGEX experiment is in conjunction with ongoing IGS operations and shall not disturb stable IGS stations nor compromise any further IGS routine delivery of data and products.

Data Center support was requested from organizations with the capability to expand their archives to include data and products from participants in this tracking campaign. Data centers interested in handling IGS MGEX data and products were asked to operate according to agreed upon IGS data format standards and follow accepted file and directory naming conventions, etc. as outlined on the IGS website. The data centers were asked to ensure that the data and products related to the experiment are archived separately from the IGS operational data set and do not affect routine operations. The data should be available online within hours after reception from the observing organizations and for at least 3 months after the experiment. Offline availability upon request should be maintained for at least 2 years.

Concerning collaborating Organizations and Networks the IGS is interested in fostering cooperation with international organizations that already operate, or are planning to operate multi-GNSS tracking networks in the near future. In this context, IGS MGEX is interested in data exchange to fill gaps in site distribution and signal coverage and to realize synergies between organizations in the exploitation of the new GNSS signals and systems.

Analysis Centers are encouraged, on a best effort basis, to use the IGS MGEX data to determine inter-system calibration biases, to compare equipment performance and to test and further develop processing software capable of handling multiple GNSS observation data. Finally, the development of multi-GNSS IGS products shall be stimulated, eventually leading to a Multi-GNSS Pilot Project.

Finally this CfP will be followed (most probably in autumn 2012) by a more definitive plan focusing on the analysis of the unique set of observations collected in the course of this call.

The due date of the proposals was October 30th, 2011 but accompanied with the clear statement that institutions may propose and join at any time. Afterwards the proposals were evaluated by the Organizing Committee until end of December. All but one proposals were accepted and the proposing organisations received individual letters covering administrative details, e.g., about the proposed data flow but also stating remaining issues of the individual proposal. As of Jan 2012 MGEX received proposals for

- 3 RINEX Data Centers (CDDIS, IGN, BKG)
- 1 Real Time Data Center (BKG)

- 7 Analyses Proposals (4 proposals from existing IGS AC +3 other institutions)
- about 25 individual sites
- 3 collaborating networks identifying altogether another 15 sites

A good mix of the most recent receiver types including also software receivers was offered. The site distribution on the other hand was not optimal with a clustering in Europe and Asia.

The official begin of MGEX was February 1st, 2012 but only a few stations started providing data exactly that date. Most of the sites started data transmission in March and April 2012. Further proposals also enhanced the global distribution of the sites. All active systems including Galileo–IOV, Compass/Beidou and QZSS as well as various SBAS satellites can be tracked. Even during the first weeks of MGEX a number of issues concerning RINEX and real–time data formats capable of handling multi–GNSS observation data came up. First details about the Analysis of the MGEX data will be presented during the upcoming IGS Workshop in Olsztyn, Poland (July 23rd–27th ,2012). The experiment is scheduled to formally end on August 31st , 2012 but there are several plans and proposals to continue MGEX operations after that date. Eventually the experiment will form a core for a Multi–GNSS IGS network providing data to generate Multi–GNSS products.

In the framework of the MGEX experiment the WG plans to involve in future also receiver manufacturers to set up a test bed for various receiver and antenna types as a prototype receiver validation facility (see also Weber, 2012).

In 2012 the IGS GNSS WG plans to prepare a white paper on the strategy for IGS participation in the mid– and longer term exploitation of the next generation of GNSS

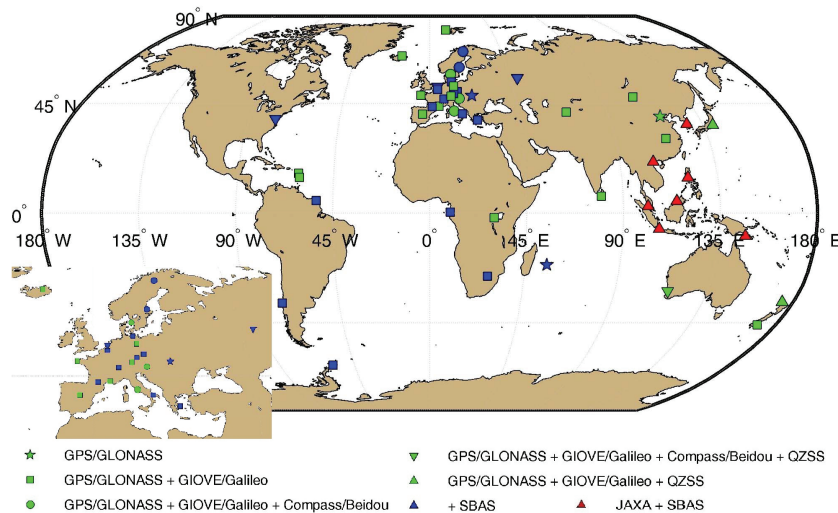

Figure 1: MGEX campaign — map of proposed sites as of March 2012

(facilitate transition of MGEX–network to regular IGS network).

Aside of MGEX, the members of the WG have contributed in 2011 to the preparation of a document listing the required satellite pre–launch calibration information relevant for IGS data processing.

References

Hugentobler, U. and R. Neilan. IGS Multi–GNSS Global Experiment, Call for Participation. [IGSMAIL #6459], 2011.

Hugentobler, U. New Satellite Systems and New Signals. Presentation at *GNSS–R Workshop*, Shanghai Astronomical Observatory, August 2011.

Weber, R., U. Hugentobler, and R. Neilan. IGS MGEX — The IGS Multi–GNSS Global Experiment. Proceedings of the *3rd International Colloquium, Scientific and Fundamental Aspects of the Galileo Program*, 30.8.–2.9.2011, Copenhagen, 2011.

Weber, R. IGS MGEX — The IGS Multi–GNSS Global Experiment Proceedings of the *Workshop on GNSS Biases* 19.01.2012 , Bern, Switzerland, 2012. <http://www.biasws2012.unibe.ch/>.

IGS Ionosphere Working Group Technical Report 2011

A. Krankowski

University of Warmia and Mazury in Olsztyn, Poland

1 General goals

The Ionosphere Working group started the routine generation of the combine Ionosphere Vertical Total Electron Content (TEC) maps in June 1998. This has been the main activity so far performed by the four IGS Ionosphere Associate Analysis Centers (IAACs):

- **CODE:** Center for Orbit Determination in Europe, Astronomical Institute, University of Bern, Switzerland,
- **ESOC:** European Space Operations Center of ESA, Darmstadt, Germany,
- **JPL:** Jet Propulsion Laboratory, Pasadena, California, U.S.A., and
- **UPC:** Technical University of Catalonia, Barcelona, Spain.

Independent computation of rapid and final VTEC maps is used by the each analysis centers: Each IAACs compute the rapid and final TEC maps independently and with different approaches including the additional usage of GLONASS data in the case of CODE.

2 Membership

1.	Dieter Bilitza	GSFC/NASA
2.	Ljiljana R. Cander	RAL
3.	M. Codrescu	SEC
4.	Anthea Coster	MIT
5.	Patricia H. Doherty	BC
6.	John Dow	ESA/ESOC
7.	Joachim Feltens	ESA/ESOC
8.	Mariusz Figurski	MUT
9.	Alberto Garcia-Rigo	UPC
10.	Manuel Hernandez-Pajares	UPC
11.	Pierre Heroux	NRCAN
12.	Norbert Jakowski	DLR
13.	Attila Komjathy	JPL
14.	Andrzej Krankowski	UWM
15.	Richard B. Langley	UNB
16.	Reinhard Leitinger	TU Graz
17.	Maria Lorenzo	ESA/ESOC
18.	A. Moore	JPL
19.	Raul Orus	UPC
20.	Michiel Otten	ESA/ESOC
21.	Ola Ovstedal	UMB
22.	Ignacio Romero	ESA/ESOC
23.	Jaime Fernandez Sanchez	ESA/ESOC
24.	Schaer Stefan	CODE
25.	Javier Tegedor	ESA/ESOC
26.	Rene Warnant	ROB
27.	Robert Weber	TU Wien
28.	Pawel Wielgosz	UWM
29.	Brian Wilson	JPL
30.	Michael Schmidt	DGFI
31.	Mahdiä Alizadeh	TU Vienna

3 Products

1. *final GIM*

(please note that GIMs also include GPS and GLONASS stations' and satellites' DCBs)

- combination of CODE, ESA, JPL and UPC iono products conducted by UWM
- temporal and spatial resolution — at $2 \text{ hours} \times 5^\circ \times 2.5^\circ$ (UTxLon.xLat.),
- availability with a latency of 11 days

2. *rapid GIM*

- combination of CODE, ESA, JPL and UPC iono products conducted by UWM
- temporal and spatial resolution — at 2 hours \times 5° \times 2.5° (UTxLon.xLat.),
- availability with a latency of less than 24 hours

3. *predicted GIM* for 1 and 2 days ahead (pilot product)

- combination of ESA and UPC iono products conducted by ESA
- temporal and spatial resolution — at 2 hours \times 5° \times 2.5° (UTxLon.xLat.),

4 Key accomplishments

- IGS Global ionosphere predicted products for 1 and 2 days ahead (pilot product). This new IGS products are currently based on predicted ionosphere maps prepared by UPC and ESA.
- IGS Global ionosphere maps with 1 hour and 15 min. time resolution (pilot products). This new IGS products are currently based on ionosphere maps prepared by UPC and ESA.
- IGS Global Ionosphere Maps (GIMs) now include differential code biases (DCBs) for GLONASS satellites.

5 Key challenges

The following goals should be achieved in the time period beginning 2011 to end 2012:

- Increase of IGS GIMs temporal resolution from current 2 hours to 1 hour. UPC and ESA conduct test on 15-minute maps, which have been tested successfully in terms of accuracy and reliability.
- Enhance time resolution of predicted GIMs from 2 hours to 1 hour or less.
- Investigate methodology required for near-real-time and real-time TEC maps.
- Investigate TEC fluctuation using ROTI.
- Further development of 3D ionosphere modeling.
- Potential use of improved of electron density retrieval techniques from GNSS LEO data (F3/COSMIC) to be used in future new IGS ionospheric products.

- Development, in cooperation with different involved colleagues of IGS, of a simple open source subroutine to correct higher order ionospheric correction (potential companion of new section of IERS recommendations on higher order ionospheric terms).

References

Hernandez-Pajares M., J. M. Juan, J. Sanz, R. Orus, A. Garcia-Rigo, J. Feltens, A. Komjathy, S. C. Schaer, A. Krankowski. The IGS VTEC maps: A reliable source of ionospheric information since 1998. *Journal of Geodesy*, 83(3-4): 263-275, 2009. doi: 10.1007/s00190-008-0266-1.

IGS Space Vehicle Orbit Dynamics Working Group Report 2011

M. Ziebart

University College London

1 Introduction

The primary aim in initiating the working group was to stimulate and coordinate research activity into orbit determination and orbit prediction of GNSS spacecraft within the IGS. The level of research activity in the area has increased considerably as a direct result of the formation of the group, although coordination between the different activities was not yet fully developed. In this report several areas of activity are described and reported, including:

- The work of several key individuals
- The acquisition of funding to support research
- The convening of conference and workshop sessions on orbit dynamics
- The development and testing of new software routines and models
- Key meetings and visits to institutions
- Publications
- Plans for the review, consolidation and extension of the group's work

All of the topics reported have been stimulated and/or supported (either directly or indirectly) by the working group.

2 People

Mari Seppanen, *Tampere University of Technology, Finland.*

Mari is working on her doctorate, and has spent a number of months at UCL working with Ziebart's group. She has carried out an extensive study of laser ranging validation of IGS GLONASS orbit products (publication in progress), and will carry on working on GLONASS orbit determination and orbit prediction problems for the next two years, with

a strong focus on surface force modelling. She will spend further term working at and with the UCL group in the next two years.

Carlos Rodriguez–Solano, *Technical University of Munich, Germany.*

Carlos is working towards his PhD under the supervision of Urs Hugentobler. He has developed several approaches to modelling earth radiation pressure effects on GPS satellites (Rodriguez–Solano et al., 2012a,b,c) and has made available Fortran code to assist groups in implementation. More recently he has developed a new model for the solar radiation impacting GPS satellites, called adjustable box–wing model (Rodriguez–Solano et al., 2012b). The model is based on the determination of novel empirical parameters, like the optical properties of the satellites surfaces and the rotation lag angle of the solar panels around their rotation axis.

Ant Sibthorpe, *NASA Jet Propulsion Laboratory, Pasadena, USA.*

Ant is working currently on the next generation orbit determination for the GPS operational control segment, and has published on the subject of orbit determination strategies for the IGS orbit products.

Liz Petrie, *University of Newcastle–upon–Tyne, UK.*

Liz is working as a post–doctoral research associate under the direction of Matt King at Newcastle. She has spent time at MIT and UCL working on updating GAMIT to trial various aspects of non–conservative force modelling developed at UCL. These models have been implemented and tested within GAMIT and Liz has spoken at international meetings on the initiative.

Stuart Grey, *University College London, UK.*

Stuart is one of two post–doctoral research associates at UCL working on space vehicle force modelling. Stuart’s background is in aeronautical engineering, with a PhD in astrodynamics. He is working on a three year research grant (commenced October 2011) at UCL concentrating on next generation approaches to earth radiation pressure modelling. He has developed a number of routines to compute solar pressure/thermal re–radiation forces on GNSS–type spacecraft utilising high power computational resources (UCL CONDOR cluster and Amazon virtual machine resources).

Shawn Allgeier, *University College London, UK.*

Shawn is the second of the UCL PDRAs and has just joined UCL after completing PhD and Masters studies in astrodynamics and physics in the USA. He has spent some time working at the US Air Force Research Laboratory.

Florian Dilssner, *European Space Operations Centre, Darmstadt, Germany.*

Florian (working alongside Tim Springer) has made significant progress in studying the attitude behaviours of GPS and GLONASS satellites close to, and within, eclipse periods using a reverse PPP technique that he has pioneered. He is the most recent addition to the working group.

3 Funding and effort

UCL has won a substantive grant (\approx £ 700 k) to work on LEO and MEO space vehicle orbit dynamics over three years employing two post-doctoral research fellows. That project started in October 2011. University of Berne, through Rolf Dach, will start a PhD project that can contribute to the effort starting in late 2012. Tampere University of Technology, Finland has kindly allowed a fully funded PhD student to work on GLONASS orbit prediction in collaboration with UCL. University of Newcastle-upon-Tyne has allocated some of Liz Petrie's PDRA effort to orbit determination work with MIT in collaboration with UCL. Finally TUM has Carlos Rodriguez-Solano's PhD dedicated to several POD force modelling topics, the PhD position is funded through the DFG Project "LEO orbit modelling improvement and application for GNSS and DORIS LEO satellites". Other groups have contributed through existing operational personnel.

4 Conference and Workshop Sessions

Ziebart (with the assistance of Urs Hugentobler and Pascal Willis, respectively) proposed and coordinated conference sessions on space vehicle orbit dynamics at the 2011 EGU and the 2011 AGU, as well as at the IGS workshop in Newcastle in 2010. These sessions were all over-subscribed for oral presentations, and brought together both a stimulating set of presentations and a good audience at each event. This was particularly successful at the Fall AGU meeting where the orbit dynamics session was given the graveyard (final) slot of the conference but still attracted a good turn out.

5 Modelling and software developments

Carlos Rodriguez-Solano has been very active, making a strong contribution. He developed, tested and distributed some routines to model earth radiation pressure forces using a strategy that enables ease of implementation and speed of computation. The routines are available at: <http://www.iapg.bv.tum.de/albedo/>.

Liz Petrie has implemented a sub-set of the UCL space vehicle force modelling routines into GAMIT, and has carried out initial tests.

Stuart Grey has created and tested an updated version of the UCL SRP/TRR modelling code to run on massively parallelised UCL resources and has also trialled it on Amazon virtual machine services. A programme of modelling runs is scheduled for the next few months developing state of the art models for several GPS, GLONASS and DORIS satellites (including Cryosat, Jason-2, SPOT-4 and SPOT-5)

Florian Dilssner has produced several excellent contributions in the understanding and modelling of yaw behaviour of several satellite blocks (Dilssner et al., 2011).

6 Key meetings and visits to other institutions

- Petrie: Research visits to UCL and MIT
- European Geosciences Union conference (2011) session on orbit dynamics
- American Geophysical Union conference (2011) session on orbit dynamics
- Ziebart: US Air Force Space Command, Colorado Springs, USA; US Air Force Research Laboratory, Albuquerque, USA; International DORIS Service meeting, Paris, 2011

7 Future Plans

There will be a plenary session, as well as a splinter group meeting at the IGS workshop in Poland in 2012, where the next steps can be discussed. A review will be held there to assess whether or not the group needs more direction and structure to its activities. Several initiatives (highlighted in this report) are underway, and they need to roll out and be extended as necessary. Several new researchers are involved in the group with substantive funding — it is anticipated that the number of tests, models, publications and general developments in insight, expertise and scientific contribution is set to grow over the next year substantially.

8 Acronyms and Abbreviations

PDRA	Post-Doctoral Research Associate
SRP	Solar Radiation Pressure
TRR	Thermal Re-radiation
UCL	University College London

Publications and References

Dilssner, F., T. Springer, G. Gienger, and J. Dow. The GLONASS-M satellite yaw-attitude model. *Advances in Space Research*, 47(1): 160–171, 2011. doi: 10.1016/j.asr.2011.03.031.

Rodríguez-Solano, C. J., U. Hugentobler, P. Steigenberger, and S. Lutz. Impact of Earth radiation pressure on GPS position estimates. *Journal of Geodesy*, 86(5): 309–317, 2012a. doi: 10.1007/s00190-011-0517-4.

Rodríguez-Solano, C. J., U. Hugentobler, and P. Steigenberger. Adjustable box-wing model for solar radiation pressure impacting GPS satellites. *Advances in Space Research*, 49(7): 1113–1128, 2012b. doi: 10.1016/j.bbr.2011.03.031.

Rodríguez-Solano, C. J., U. Hugentobler, and P. Steigenberger. Impact of Albedo Radiation on GPS Satellites. *Geodesy for Planet Earth*, S. Kenyon, M. C. Pacino and U. Marti (Eds.), Springer Berlin Heidelberg. 136: 113–119, 2012c.

IGS Reference Frame Working Group Coordinator Report 2011

P. Rebischung¹, B. Garayt², X. Collilieux¹, Z. Altamimi¹

¹ IGN, Institut National de l'Information Géographique et Forestière, LAREG and GRGS
6-8 avenue Blaise Pascal, 77455 Marne-la-Vallée Cedex 2, France
E-mail: paul.rebischung@ign.fr

² IGN, Institut National de l'Information Géographique et Forestière, SGN and GRGS

1 Introduction

Since February 2010, the Institut Géographique National (IGN) has replaced Natural Resources Canada (NRCAN) as coordinator of the IGS Reference Frame Working Group. On the operational side, this coordination consists in combining the weekly SINEX solutions provided by the IGS final Analysis Centers (ACs) and updating a long-term cumulative solution each week (Kouba et al., 1998; Ferland and Piraszewski, 2009). The switch from NRCAN to IGN was the opportunity to bring some changes to the SINEX combination strategy (Rebischung and Garayt, 2012). But the formats and contents of all products were kept unchanged so as to ensure a smooth transition.

Besides a continuous monitoring of the SINEX combination results, the main achievement of the Reference Frame Working Group in 2011 was the publication of IGS08 (Rebischung et al., 2011), a new IGS reference frame based on ITRF2008 (Altamimi et al., 2011). Another specific effort was made to obtain a homogeneous set of weekly solutions based on the IGN combination strategy back to 1994 and to form a new, modernized IGS cumulative solution. Finally, a website that promotes the SINEX combination products has started to be developed and should be made publicly available in 2012.

2 Recent SINEX combination results

Since 2000, the IGS Reference Frame Working Group Coordinator combines the weekly SINEX solutions provided by the IGS final ACs, which include station positions and Earth

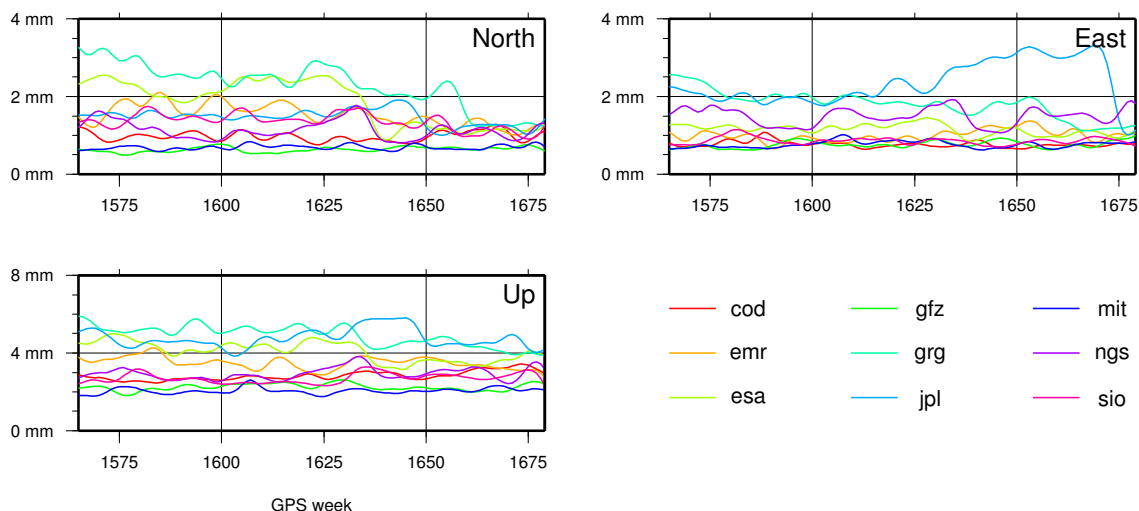

Figure 1: RMS of AC station position residuals from January 2010 to March 2012 (All time series were low-pass filtered with a 5 cpy cut-off frequency.)

orientation parameters (EOPs). The combination residuals reflect the level of agreement of AC solutions with each other and are thus traditionally used as precision indicators for the combined products.

Figure 1 shows the RMS of the station position residuals of each AC from January 2010 to March 2012. While ACs which dominate the SINEX combinations (MIT and GFZ) have rather constant RMS over that period, significant progress can be seen for other ACs, mainly:

- for ESA and GRG, in the North component, thanks to the introduction of horizontal tropospheric gradients on GPS weeks 1637 and 1659, respectively,
- for JPL, in the East component, thanks to the fix of a bug related to ground antenna phase center corrections on GPS week 1674.

AC contributions to the SINEX combination have thus recently become more homogeneous, with RMS of station position residuals now below 2 mm in North, East and 5 mm in Up for all ACs.

Figures 2 and 3 show the AC EOP residuals from January 2010 to March 2012. Over this period, the internal consistency of the AC pole coordinates, pole rates and LODs have been at the 20 – 50 μas , 100 – 200 $\mu\text{as}/\text{day}$ and 10 – 15 μs RMS levels respectively. These consistency levels are in fact stable since 2008 (Ferland and Piraszewski, 2009), confirming that IGS final EOP errors seem to have reached an asymptotic limit probably due to limitations in orbit modeling and subdaily EOP models (Ray and Ferland, 2009).

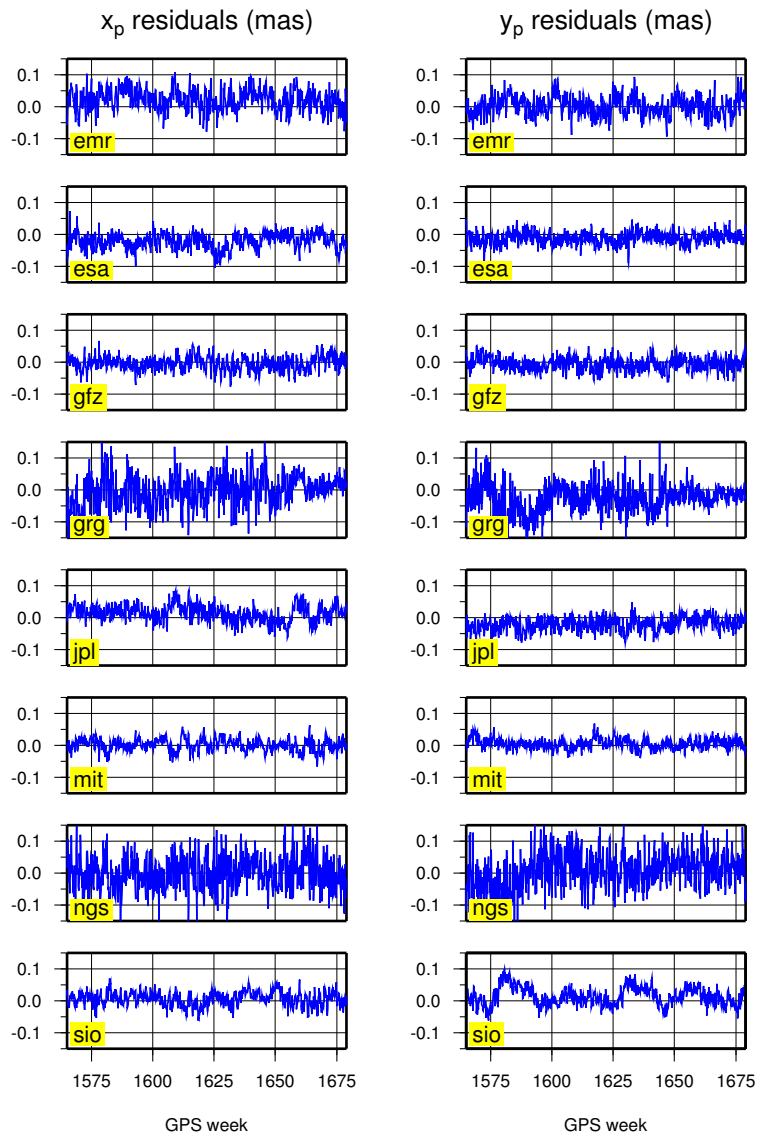

Figure 2: AC pole coordinate residuals from January 2010 to March 2012

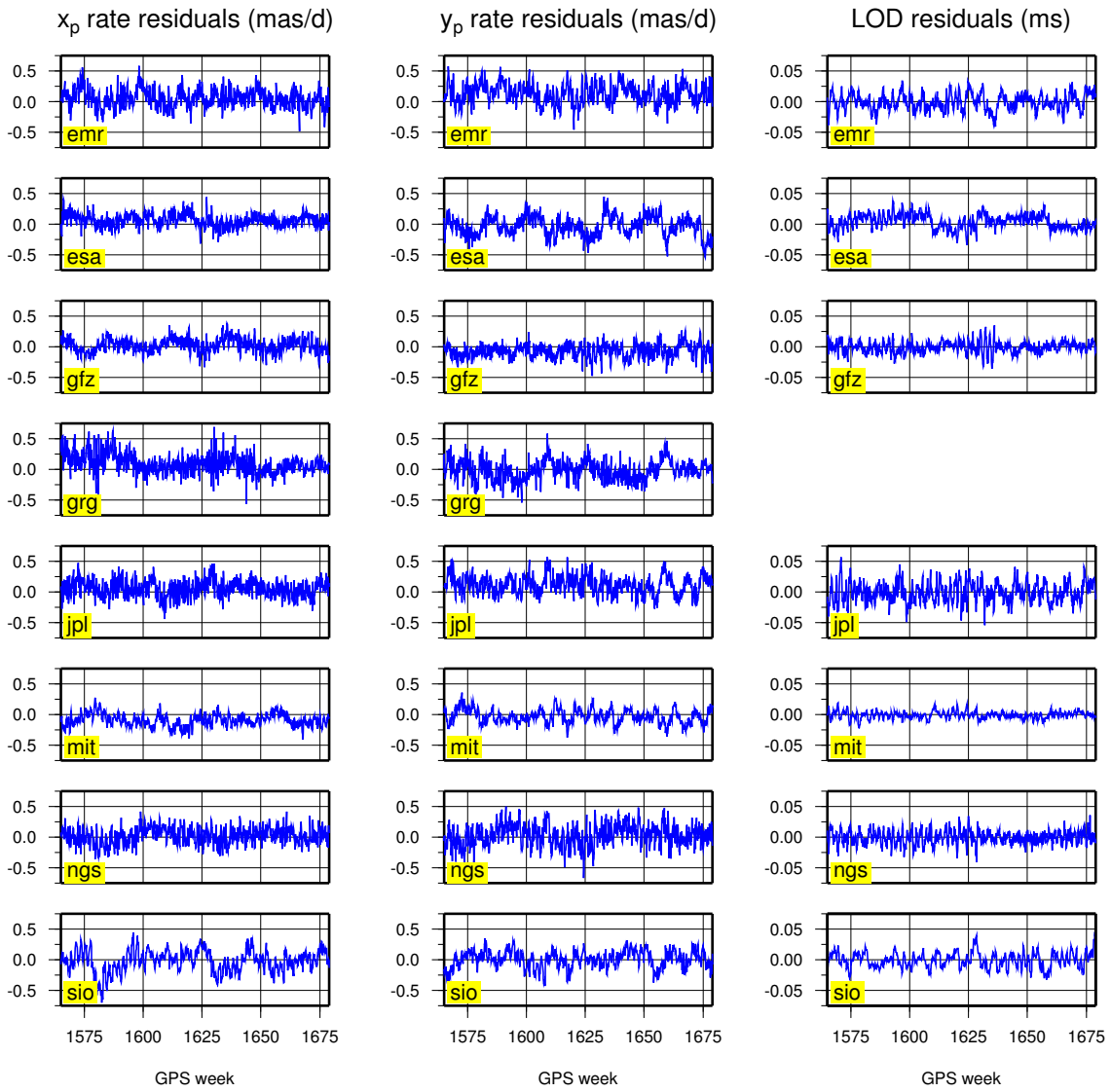

Figure 3: AC pole rate and LOD residuals from January 2010 to March 2012

3 IGS08 and IGB08

On April 17, 2011, a new reference frame called IGS08 (Rebischung et al., 2011) was adopted by the IGS and replaced IGS05 (IGS Mail #5447). IGS08 is based on an extraction of 232 stable GNSS stations from ITRF2008 (Altamimi et al., 2011). But in order to make IGS08 consistent with the new set of antenna calibrations simultaneously adopted by the IGS (*igs08.atx*, IGS Mail #6354), corrections were applied to the ITRF2008 positions of 65 IGS08 stations. A smaller well-distributed network of 91 stations was additionally designed and called IGS08 core network. It is intended to reduce the “network effect” that occurs when aligning quasi-instantaneous frames to a secular reference frame. The IGS08 core network is in particular used to align the IGS weekly combined solutions to IGS08 since its adoption.

However, many IGS08 stations have already been affected by position discontinuities that have made them unusable as reference stations, and the geometry of the IGS08 core network has thus seriously degraded. That is why a first update of IGS08, called IGB08, has been proposed. IGB08 includes new sets of coordinates for 28 IGS08 stations having been affected by position discontinuities and 3 new stations co-located with decommissioned IGS08 stations (Figure 4). The adoption of IGB08, planned before the end of 2012, would increase the number of usable core stations by a dozen (Figure 5).

In parallel to the maintenance of IGS08 and in preparation of the second IGS reprocessing campaign, actions were taken in view of strengthening the IGS network and reference frame in South America, Africa, Asia and Pacific. Concerning South America, discussions with Laura Sanchez (DGFI/SIRGAS) and station operators led to a selection of 38 potential IGS stations whose data have been made available to IGS ACs. ACs were encouraged to process these new stations, especially in the second reprocessing campaign, so that they could become part of the next IGS reference frame.

The African Geodetic Reference Frame (AFREF) and Asia-Pacific Reference Frame (APREF) sub-commissions have similarly been asked to propose candidate stations.

4 The “*igb*” re-combination and the new IGS cumulative solution

In early 2011, new combinations of AC reprocessed SINEX solutions for weeks 0730–1459 and of AC operational solutions for weeks 1460–1631 were performed at IGN. The main goal of this effort was to obtain a homogeneous set of weekly combined solutions, based on the latest IGN combination strategy and covering the whole IGS time period. The *igb* weekly combined solutions, available in the *repro1* directories of the IGS global data centers, show little differences with the official *ig1/igs* solutions, except that they include all stations processed by the ACs (more than 900 in total). A special set of

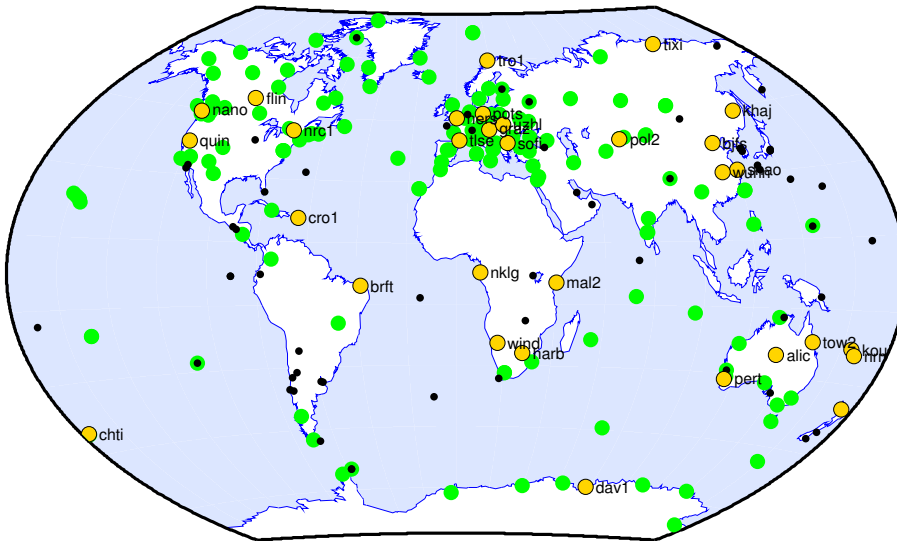

Figure 4: State map of the IGS08 network on GPS week 1674. Green dots are usable IGS08 stations. Orange dots are the 31 IGS08 stations which would be recovered with the adoption of IGb08. Black dots are unrecoverable IGS08 stations.

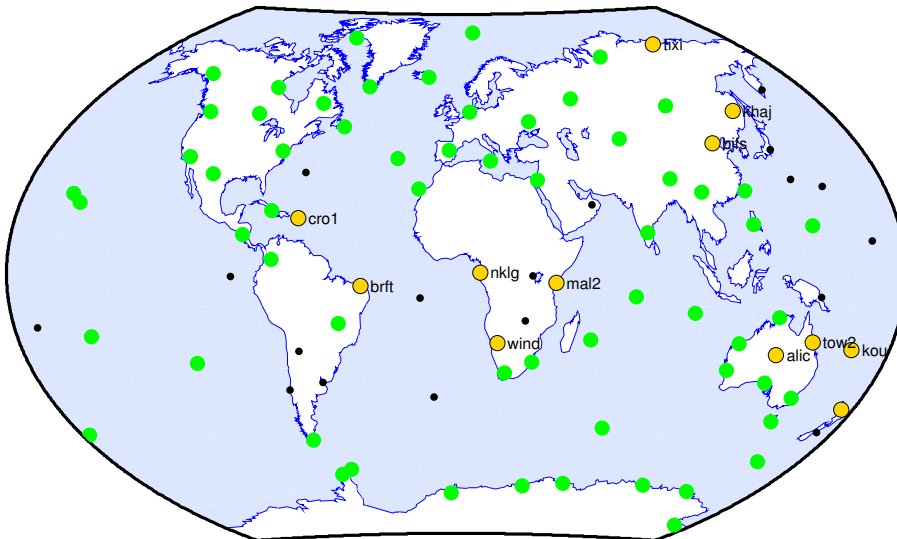

Figure 5: State map of the IGS08 core network on GPS week 1674. Green dots are usable IGS08 core stations. Orange dots are those which would be recovered with the adoption of IGb08. Black dots are unrecoverable IGS08 core stations.

weekly combined solutions aligned in orientation only to ITRF2008 was also derived and is available on request. The absence of network effect due to alignment in origin and scale makes those latter solutions more suited for studying station displacements and for research purposes.

The igb re-combination was also an opportunity to modernize the IGS cumulative solution. Until week 1631, the IGS cumulative solution was indeed obtained by stacking the operational weekly combined solutions. It is now based on the longer, homogeneous igb dataset and on the operational weekly solutions since week 1632. The new IGS cumulative solution also benefits from a revised list of position and velocity discontinuities and from the addition of constraints that impose station velocities to be equal before and after a position-only discontinuity.

5 The SINEX combination website

In order to promote the use of the IGS SINEX combination products and improve their accessibility, the project of developing a “showcase website” was initiated in 2011. Its main features are:

- a map interface providing access to all stations processed by the IGS ACs (Figure 6),
- time series visualization and manipulation tools (Figure 6),
- web services that will provide access to all products of the SINEX combinations.

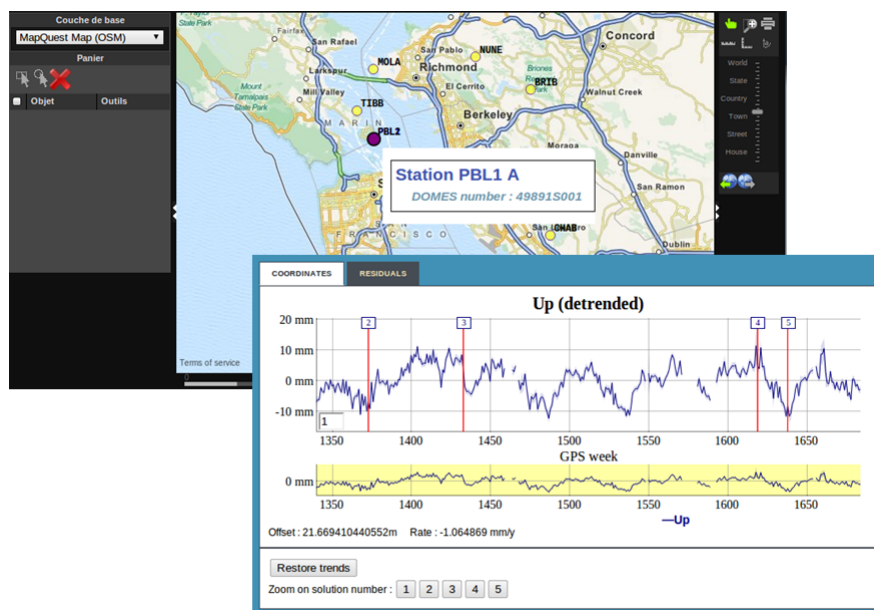

Figure 6: Map interface and time series visualization interface of the SINEX combination website

The website should be made publicly available in 2012 at: <http://webigs.ign.fr>.

References

- Altamimi, Z., X. Collilieux and L. Métivier. ITRF2008: an improved solution of the International Terrestrial Reference Frame. *Journal of Geodesy*, 85(8):457–473, 2011.
- Ferland, R. and M. Piraszewski. The IGS-combined station coordinates, earth rotation parameters and apparent geocenter. *Journal of Geodesy*, 83(3–4):385–392, 2009.
- Kouba, J., J. Ray, and M. M. Watkins. IGS Reference Frame Realization. *IGS Analysis Center Workshop Proceedings*, Darmstadt, Germany, 139–172, 1998.
- Ray, J. and R. Ferland. Status and prospects for IGS polar motion measurements. *IERS Workshop on EOP combination and prediction*, Warsaw, Poland, 2009.
- Rebischung, P., J. Griffiths, J. Ray, R. Schmid, X. Collilieux, and B. Garayt. IGS08: the IGS realization of ITRF2008. *GPS Solutions*, published online, 2011. doi: 10.1007/s10291-011-0248-2
- Rebischung, P. and B. Garayt. Recent results from the IGS terrestrial frame combinations. IAG Symp. 138, Springer, in press, 2012.

Real-Time Working Group and Real-Time Pilot Project

M. Caissy¹ and L. Agrotis²

¹ Natural Resources Canada, Geodetic Survey Division
615 Booth Street, Ottawa, Canada K1A 0E9
Mark.Caissy@nrcan.gc.ca

² European Space Operations Centre

1 Introduction

The IGS Real-Time Working Group (RTWG) was established in 2001 with the goal to design and implement real-time infrastructure and processes for the delivery of real-time data to analysis centres, and the dissemination of real-time products to users. In June 2007, the IGS announced the Call for Participation in the IGS Real-Time Pilot Project (RTPP) with a three-year target to accomplish its goals. In December 2010 a new consolidated charter was adopted for both the RTWG and RTPP with new goals for the period 2011-2012. These goals would demonstrate the IGS's ability to offer real-time GNSS data and real-time GPS orbits and clocks as part of a new IGS Real-Time Service (RTS). Under this joint framework, the pilot project has been demonstrating existing real-time capabilities while the working group has been focused on enhancing and extending these capabilities through the implementation of the recommendations from both the Miami (2008) and Newcastle (2010) workshops. A complete list of these recommendations can be found at: <http://igs.cb.jpl.nasa.gov/overview/pubs.html>. This Technical Report covers the period beginning the 3rd quarter of 2010 and ending December 31st, 2011. During this period, the RTWG and pilot project participants began to implement several key recommendations which came out of discussions at the workshops. These included:

- The decision for the IGS to join the Radio Technical Commission for Maritime Services Special Committee 104 (RTCM-SC104).
- The need to implement a robust data distribution model to real-time analysis centres.
- The need to implement a robust real-time clock combination product.
- The need to provide quality assurance of real-time orbit and clock corrections.

2 The IGS Real-Time Network

The real-time network is fundamentally the source of the real-time GNSS data which is needed to generate real-time GNSS products. Figure 1 illustrates the distribution of real-time tracking stations as of October 2011. This network contains approximately 130 globally-distributed stations maintained by a wide variety of local and regional operators. These stations deliver one-hertz data to the real-time data centres with typical latencies of 3 seconds or less. Global coverage is essential and the presence of redundant stations in geographical regions enhances the reliability of data available from these regions. Station operators are required to adhere to a minimum set of standards and are also encouraged to adopt a number of best practices including:

- Real-time data should be transmitted to a minimum of two separate real-time data centres.
- Stations that contribute to the realisation of the IGS reference frame should be operated in real-time in order to guarantee a reliable alignment of the real-time products to a stable reference frame.

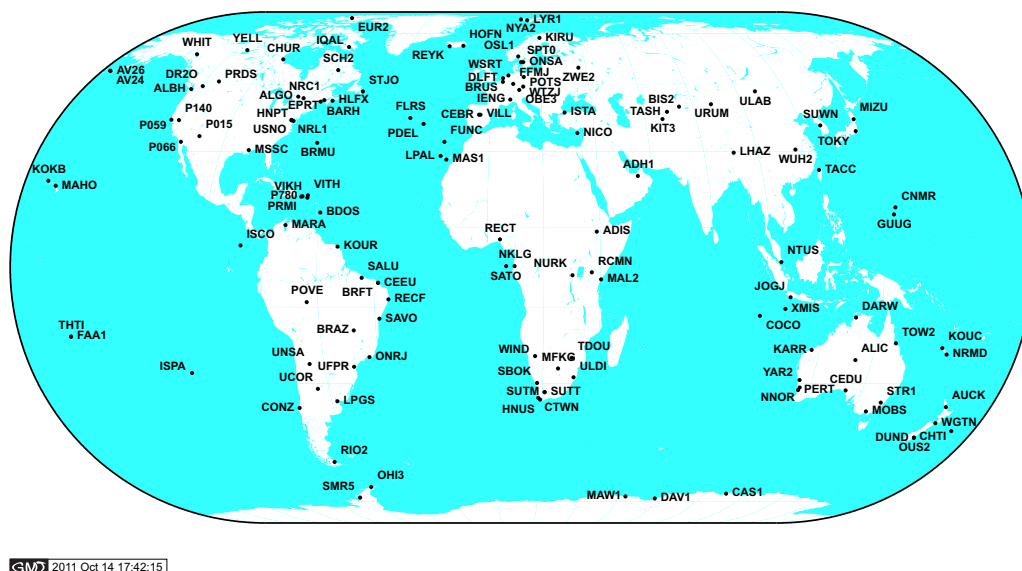

Figure 1: The IGS Real-Time Network.

3 Radio Technical Commission for Maritime Services Special Committee 104

Following a decision made at the Miami workshop, the IGS became a member of the Radio Technical Commission for Maritime Services Special Committee 104 (RTCM-SC104) in 2009. In 2010 and 2011 members of the RTWG represented the IGS at six RTCM meetings. RTWG members have been able to influence RTCM decisions pertaining to the development and adoption of formats for real-time GNSS observation data, and orbit and clock correction information. The working group and pilot project have adopted the RTCM-3 format for GPS and GLONASS observation streams and the RTCM-State Space Representation (RTCM-SSR) format for orbit and clock correction message streams. The working group continues to influence the development of RTCM Multiple Signal Messages (MSM) modelled on the RINEX 3 data format, another Miami recommendation. The new MSM format is expected to become an RTCM standard in 2012.

The RTWG has adopted the Network Transport of RTCM by Internet Protocol (NTRIP) for internal operations and for the delivery of real-time products to users. The adoption of NTRIP supports the Newcastle recommendation to promote the development and use of freely available positioning software and standards. Real-time users can gain access to RTS products through the use of open source software that uses RTCM standards (RTCM-3, SSR, MSM, and NTRIP). Two examples of software that is currently available include BKG's NTRIP Client (BNC) and RTKLIB software, developed by T. Takasu. Both software products support a variety of GNSS positioning applications. It is predicted that in the future GNSS receiver manufacturers will perform real-time precise point positioning (RTPPP) directly in their receivers using an NTRIP client front end and embedded algorithms that use SSR correction information to compute sub-decimetre accurate positions in real time.

4 Robust Data Distribution to Real-Time Analysis Centres

The Newcastle workshop identified a weakness in the manner in which data was being delivered to RTACs. In an effort to address this weakness a network topology has been implemented by several agencies. Figure 2 illustrates the single tracking station and regional network architecture. This arrangement specifies that data streams from the tracking stations should be sent to two separate real-time data centres where they become available to RTACs. In this architecture, analysis centres can source reference station data from more than one data centre. This design reduces the likelihood of single points of failure, making the data network and delivery to RTACs more robust.

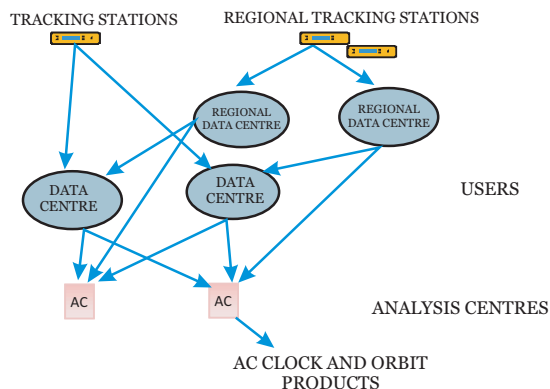

Figure 2: GNSS station to data centre architecture.

5 Robust Real-Time Clock Combination Product

The Newcastle workshop also identified a weakness due to a lack of redundancy in the combination process. To address this weakness, a second combination server was installed at an independent location. Figure 3 illustrates the analysis-centre to combination-centre to user-network architecture. As with the classical orbit and clock products, the reliability of real-time products is assured through the creation of a combined product that is based on submissions from a minimum of three real-time analysis centres. Analysis centres are encouraged to adopt the best practice of sending generated product streams to the two independent combination centres. To ensure the availability of products, users have redundant data centres from which to choose real-time products.

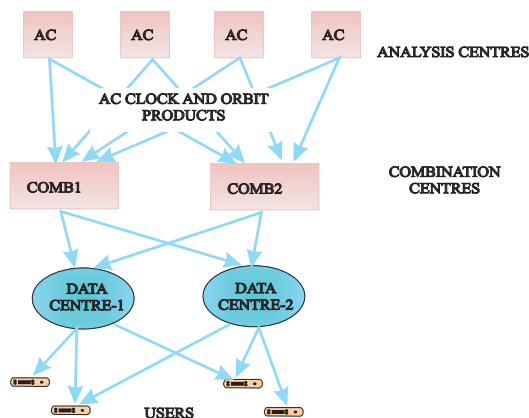

Figure 3: RTS GNSS product distribution architecture.

6 Quality Assurance of Real-Time Orbit and Clock Corrections

Quality assurance of real-time clocks and orbits was identified at the Newcastle workshop to be an area needing improvement. Since 2009 the quality of the individual RTAC clock solutions has been derived using comparisons with IGS rapid clock products. Table 1 shows snapshots of the performance of RTAC and combined products in the RTPP since 2009. The quality of the individual RTACs and the combined products is assessed through the root-mean-square (RMS) and standard deviation (sigma) of the difference between the individual products and the IGS rapid clock product. The target for the pilot project was to produce a combined clock product accurate to within 0.3 nanoseconds when compared to IGS rapid products. This was achieved early on in the project.

The real-time analysis centre coordinator (RTACC) combination method detects and removes outliers that may be present in individual solutions. The combination is generated by first aligning all the solutions to a reference solution by removing a common solution-specific offset from all the satellite clocks. After alignment, clock differences between pairs of solutions are processed for outlier detection and for generation of a combination product. Satellite orbits are combined using solution averages after outlier detection. Figure 4 shows the history of the clock RMS performance of the single-epoch combination solution against the IGS “rapids”. This was the first combination product generated by the RTPP. It started as a batch combination from daily orbit and clock file submissions by the RTACs. Early in 2010, ESOC started providing the first real-time combination product, generated directly by processing the real-time correction streams. The batch combination is in blue, while the real-time combination, starting in 2010, is in red. After an initial improvement phase, the results are stable except for occasional outliers. The outliers are

Table 1: Real-time pilot project clock product comparisons.

Analysis Centre	Feb 6 2009		June 8 2010		June 15 2011	
	Clock RMS (ns)	Clock Sigma (ns)	Clock RMS (ns)	Clock Sigma (ns)	Clock RMS (ns)	Clock Sigma (ns)
Comb	0.22	0.22	0.16	0.10	0.14	0.07
RTComb	—	—	0.15	0.11	0.18	0.08
BKG / CTU	6.72	2.97	0.20	0.12	0.30	0.07
CNES	—	—	—	—	0.30	0.03
DLR	0.38	0.10	0.20	0.12	0.25	0.12
ESOC	0.42	0.38	0.21	0.12	0.17	0.12
GFZ	—	—	—	—	0.33	0.06
NRC	0.67	0.62	0.24	0.10	0.23	0.07
GMV	1.67	1.66	0.28	0.14	0.34	0.10
TUW	—	—	0.70	0.53	0.73	0.53
WUH	—	—	—	—	0.57	0.07

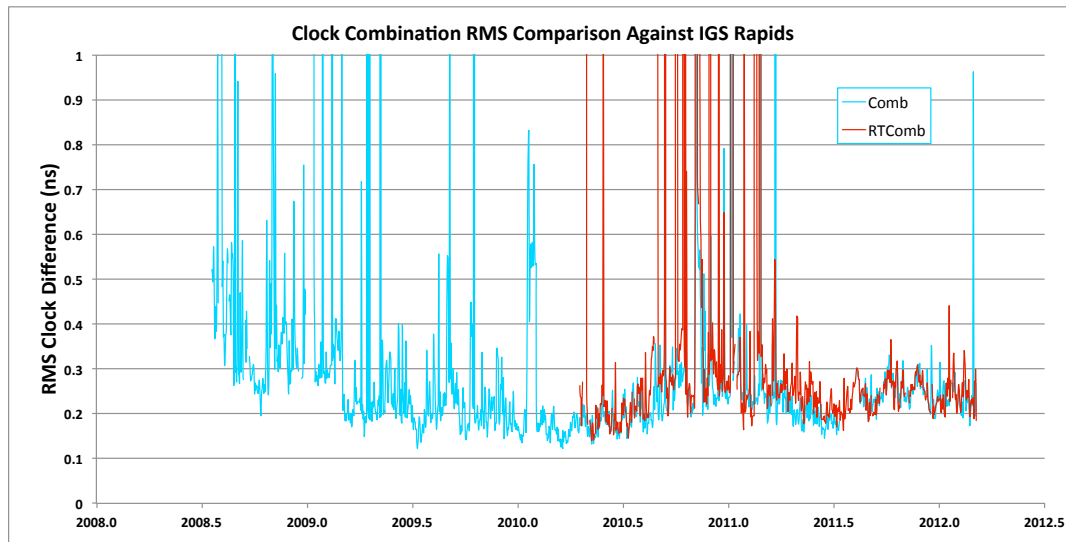

Figure 4: Combination solution clock performance.

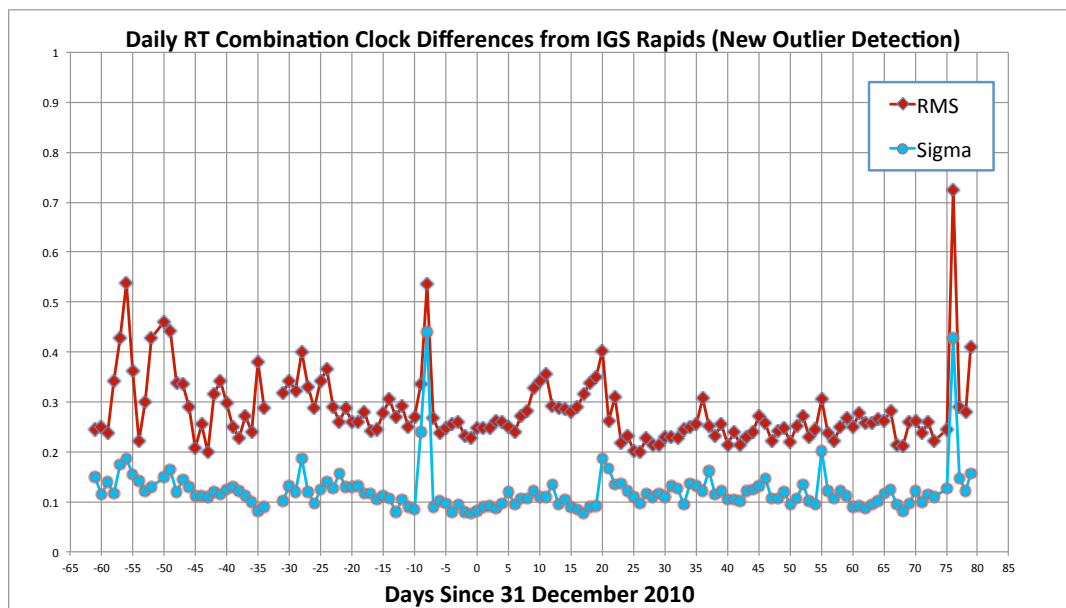

Figure 5: RT Combination solution performance with improved outlier detection.

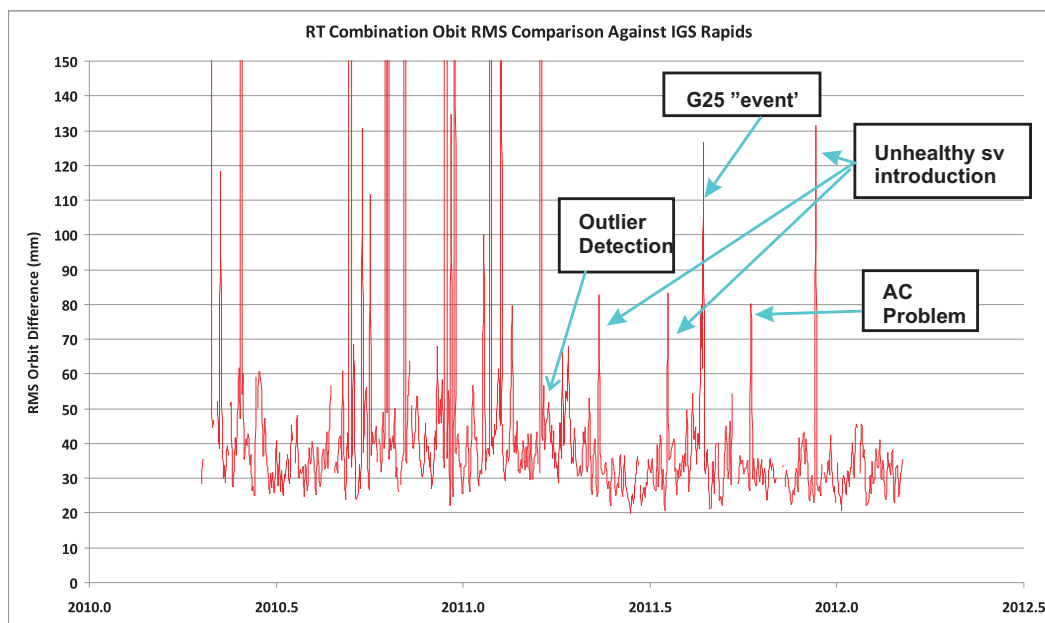

Figure 6: Combination solution orbit performance.

due to problems in the individual solutions, and these should be removed by a properly executed combination methodology. Outliers in the combination towards the end of 2010 and beginning of 2011 were caused by RTCM encoding errors in some RTAC streams. Improvements to the outlier detection algorithm were introduced in early 2011 and it can be seen that the incidence of results with high RMS have been drastically reduced. Most outliers are now caused by poor orbit results after satellite manoeuvres. Figure 5 illustrates the effectiveness of the outlier-detection algorithm.

7 Further Reading

- <http://www.rtigs.net/docs/IGS-Report-2010-RTWG-RTPP.pdf>
- <http://www.rtigs.net/docs/IGS-Report-2011-RTWG-RTPP.pdf>

References

Agrotis, L., P. Alfaro Sanz, J. Dow, R. Zandbergen, D. Svehla, and A. Ballereau. ESOC's RETINA System and the Generation of the IGS RT Combination. *IGS Workshop*, Newcastle, June 2010.

- Caissy, M., L. Agrotis, G. Weber, M. Hernandez-Pajares, and U. Hugentobler. The International GNSS Real-Time Service. *GPS World Innovation*, 1 June 2012. <http://www.gpsworld.com/gnss-system/augmentation-assistance/innovation-coming-soon-13044>
- Caissy, M., G. Weber, L. Agrotis, G. Wübbena, and M. Hernandez-Pajares. The IGS Real-time Pilot Project — The Development of Real-time IGS Correction Products for Precise Point Positioning. Presented at EGU, Vienna, April 2011.
- Weber, G., L. Mervart, L. Agrotis, and A. Stürze. Real-time Combination of GNSS Orbit and Clock Correctors for Precise Point Positioning. presented at *IUGG/IAG General Assembly*, Melbourne, July 2011.
- Weber, G. and L. Mervart. Real-time Combination of GNSS Orbit and Clock Correction Streams Using a Kalman Filter Approach. ION GNSS, 2010.
- Weber, G., D. Dettmering, H. Gebhard, and R. Kalafus. Networked Transport of RTCM via Internet Protocol (Ntrip), IP-Streaming for Real-Time GNSS Applications. ION GNSS, 2005.

IGS RINEX Working Group Report 2011

K. MacLeod¹ and L. Agrotis²

¹ Natural Resources Canada
E-mail: ken.macleod@nrcan.gc.ca

² European Space Agency
E-mail: loukis.agrotis@esa.int

Membership:

Name	Institution	Country	E-mail
A. Boriskin	Ashtech	Russia	aboriskin@ashtech.com
A. Hauschild	DLR	Germany	andre.hauschild@dlr.de
A. Zinoviev	Topcon	Russia	azinoviev@topcon.com
B. Lemoine	Hemisphere	Canada	blemoine@hemispheregps.com
D. Stoecker	Alberding University	Germany	dirk.stoecker@alberding.eu
D. Kolosov	Topcon	Russia	dkolosov@topcon.com
D. Kozlov	Ashtech	Russia	dkozlov@ashtech.com
F. Pache	Leica Geo.	Switzerland	franck.pache@leica-geosystems.com
F. Takac	Leica Geo.	Switzerland	frank.takac@leica-geosystems.com
G. Lu	Trimble	USA	gang_lu@trimble.com
G. Weber	BKG	Germany	georg.weber@bkg.bund.de
G. Wübbena	Geo++	Germany	gerhard.wuebbena@geopp.de
G. Roesler	Novatel	Canada	greg.roesler@novatel.com
H. J. Euler	Inposition	Switzerland	h-j.euler@inposition.ch
Y. Hatanaka	GSI	Japan	hata@gsi.go.jp
H. Habrich	BKG	Germany	heinz.habrich@bkg.bund.de
J. M. Sleewaegen	Septentrio	Belgium	jm.sleewaegen@septentrio.com
J. Sass	Ashtech	USA	jsass@ashtech.com
K. Kaori	JAXA	Japan	kawate.kaori@jaxa.com
K. Ferguson	Trimble	USA	kendall_ferguson@trimble.com
L. Estey	UNAVCO	USA	lou@unavco.org
M. Schmitz	Geo++	Germany	martin.schmitz@geopp.de
M. Kirchner	Astrium	Germany	michael.kirchner@astrium.eads.net
M. Miyoshi	JAXA	Japan	miyoshi.motoyuki@jaxa.jp
M. Schmidt	NRCAN	Canada	mschmidt@nrcan.gc.ca

Name	Institution	Country	E-mail
I. Romero	ESA	EU	nacho@canaryadvancedsolutions.com
O. Colombo	NASA	USA	oscar.l.colombo@NASA.GOV
P. Alves	Novatel	Canada	paul.alves@novatel.com
P. Kopcha	NGA	USA	peter.d.kopcha@nga.mil
B. Renfro	U of Texas	ESA	renfrob@arlut.utexas.edu
R. Dach	U of Bern	Switzerland	rolf.dach@aiub.unibe.ch
S. Hilla	NGS	USA	steve.hilla@noaa.gov
T. Stansell	Stansell C	USA	tom@stansell.com
U. Rossbach	IFEN	Germany	u.rossbach@ifen.com
T. Willems	Septentrio	Belgium	t.willems@septentrio.com
T. Noack	DLR	Germany	thoralf.noack@dlr.de
T. Springer	ESA	Germany	tim.springer@esa.int
T. Petersen	Trimble	USA	tim_petersen@trimble.com
L. Agrotis	ESA	GB	loukis.agrotis@esa.int
K. MacLeod	NRCan	Canada	ken.macleod@nrcan.gc.ca

Charter

last updated: 2011

1 Overview:

RINEX 2.1X is currently the primary archival format used within the IGS and the GNSS industry. However, since RINEX 2.1X was designed in the mid 1990s, primarily to support GPS, it has proved difficult to extend RINEX 2.1X to support new GNSS constellations and signals. As a result of the shortcomings of RINEX 2.1X, RINEX 3.0X was designed to provide generic and systematic support for: GNSS constellations, signals and observations. Given the needs of the IGS community and the strengths of RINEX 3.0X, the IGS plans to support RINEX 3.0X.

It is understood by the IGS that the transition from RINEX 2.1X to 3.0x, has to be done in partnership with the GNSS community. One of the first steps in this transition occurred in 2009 when the IGS joined the Radio Technical Commission for Maritime services–Special Committee 104 (RTCM–SC104). The primary objective of joining RTCM–SC104 was to more effectively communicate the needs of the IGS community to the GNSS industry and receiver manufacturers in particular. Since joining RTCM–SC104 the IGS has contributed to the development of an open, generic, high precision and multi–GNSS binary observation format called RTCM–Multiple Signal Messages (RTCM–MSM). The RTCM–MSM format supports the creation of fully defined, phase aligned RINEX 3.0x observations files. In 2011 the IGS and RTCM–SC104 further agreed to jointly manage development and documentation of the RINEX 3.0X format. It is believed that the synergy derived by having RINEX within the RTCM–SC104 will help both the IGS and the GNSS industry achieve

an orderly and efficient transition to RINEX 3.0X. Furthermore, to facilitate the transition to RINEX 3.0X the IGS/RTCM–SC104 RINEX Working Group is encouraging and supporting the development of several open source software tools that will both convert RTCM to RINEX 2.1X and 3.0X formats and provide data quality control measures.

2 Activities in 2011:

- Loukis Agrotis attended January RTCM meeting in Germany.
- Ken MacLeod attended RTCM meetings in May (St. Pete’s Beach, Florida) and September (Portland, Oregon). RTCM–SSR message format approved.
- Contributed to the RTCM–Multiple Signal Message definition.
- Proposed additional RTCM messages to support the creation of a RINEX file from a binary station stream. Also included a change control parameter to enable/disable real–time stream processing and trigger the automatic updating of IGS station logs.
- RINEX Working Group established. Consists of both IGS and RTCM–SC104 participants.
- Updated RINEX 3.0X to version 3.02 and added support for the QZSS Constellation
- Distributed draft RINEX 3.02 document to Working Group

3 Key challenges:

- Communicating the need to transition from RINEX 2.1X to 3.02
- Getting support from IGS members
- Getting software developers to support RINEX 3.02
- Implementing the transition plan from RINEX 2.1x to 3.0X

4 Products:

- RINEX 3.02 Documentation
- Contributed to the definition of high precision RTCM–SC104: Multiple Signal Messages

5 Publications/Presentations:

- Prepared RINEX 3.02 Draft
- Prepared RTCM presentation, concerning proposed new messages for: station, receiver, antenna, met. sensor and met data.
- IGS Governing Board presentation (December 2011)

6 2012–2013 Activities:

- Continue to update RINEX 3.02 to meet the needs of both industry and the IGS.
- Develop a RINEX version to support experimental (QZSS: SAIF, LEX) and poorly documented constellations and signals (Compass).
- Develop and recommend an IGS transition plan from RINEX 2.1X to 3.0X to IGS GB.
- Develop and communicate a RINEX 3.02 implementation plan to IGS and industry partners at the 2012 Workshop.
- Work with IGS and industry partners to encourage RINEX 3.02 support
- Attend RTCM–SC104 and IGS meetings
- Contribute to the definition the RTCM–Multiple Signal Message Format and other RTCM messages that meet the needs of the IGS
- Encourage the development of Open Source software that supports the RINEX 3.0X format

7 IGS Multi–GNSS Experiment Support:

- The RINEX 3.02 draft supports all the current GNSS constellations and signals that are available to be tracked by the IGS Multi–GNSS Experiment.

8 IGS Strategic Plan Support:

- The IGS/RTCM RINEX Working Group develops GNSS observation formats to support all GNSS constellations and signals.

9 References/Links

1. RTCM–Multiple Signal Message Document: 034-2012-SC104-693.doc
2. GPS Interface Control Documents: <http://www.gps.gov/technical/icwg/>
3. GLONASS Interface Control Documents:
http://www.spacecorp.ru/en/directions/glonass/control_document/
4. Galileo ICD: http://ec.europa.eu/enterprise/policies/satnav/galileo/open-service/index_en.htm
5. QZSS ICD: http://qz-vision.jaxa.jp/USE/is-qzss/index_e.html
6. Compass ICD: <http://www.beidou.gov.cn/attach/2011/12/27/201112273f3be6124f7d4c7bac428a36cc1d1363.pdf>

The Tide Gauge Benchmark Monitoring Project

*T. Schöne, R. Bingley, Z. Deng, J. Griffiths, H. Habrich, M. Jia,
M. King, M. Merrifield, G. Mitchum, R. Neilan, C. Noll,
L. Sánchez, N. Teferle, D. Thaller, P. Tregoning,
P. Woodworth, G. Wöppelmann*

1 Introduction

Present-day sea level rise with its potential impact on people living close to the oceans is an important societal issue. For decades to centuries the sea level with its tides has been measured using coastal tide gauges. However, these measurements only constitute a local datum, affected not only by climate related changes but also by local land changes. Many studies have estimated global sea level rise using selected sets of tide gauge records (most prominent, Douglas, 1991). Throughout time the geodetic fixing of the tide gauge zero has been improved allowing to relate the readings from different occupations to a common local datum. However, even with a large number of well-established benchmarks the tidal readings and derived sea level quantities remain in a local reference frame. Thus, today's challenges are still the establishment of a height reference for tide gauges connected to a global long-term stable reference system (e.g., Carter et al., 1989; Carter, 1994; Blewitt et al., 2010), establishing a global vertical height datum (e.g., Ihde et al., 2007; Sánchez and Bosch, 2009) and to provide correction to facilitate the distinction between the relative and geocentric sea level changes by accounting for the vertical uplift of the station (e.g., Wöppelmann et al., 2007).

Space geodetic techniques are the most viable technique to establish this necessary reference for large numbers of globally distributed sites. With the advent of GPS in the late 1980s the establishment of an easily to access and global stable reference system became feasible. In 1994 the first continuous GPS stations started operation near tide gauges. Over the years the number of co-located GPS/tide gauge has increased constantly and studies demonstrated the potential for tide gauge fixing. A workshop held in Pasadena in 1997 (Neilan et al., 1997) brought together the oceanographic and geodetic community and started with the implementation of a long-term plan for the establishment of a global

network of GPS–equipped tide gauges. A technical committee jointly setup by the International GNSS Service (IGS, formerly International GPS Service), the Permanent Service for Mean Sea Level (PSMSL) and GLOSS defined the technical standards for stations (Bevis et al., 2002). A GLOSS workshop (Group of Experts Meeting) in Hawaii (IOC 2001) concluded the findings, and a Charter and Terms of References for a dedicated IGS Pilot Project were drafted. The IGS formally established the Tide Gauge Benchmark Monitoring Pilot Project (TIGA) in 2001 (adsc.gfz-potsdam.de/tiga, Schöne et al., 2009). The aim of the service was to derive geocentric coordinates and time series of vertical motion for a large set of globally distributed tide gauges co-located with GNSS stations in support of scientific studies.

This pilot project was successfully operated for more than nine years. Over this period many achievements have been made; single products are now widely used in many different applications. To reflect the successful initial period, at its 37th meeting the IGS Governing Board accepted the proposal for a transition of the TIGA Pilot Project to an IGS Working Group. The generation of the primary product — geocentric coordinates, velocities and time series of coordinates of the TIGA network — will become more regular. In addition, the TIGA Working Group will analyze the results of TIGA to identify station discontinuities and to further improve the way the height component is modeled and computed in GNSS processing.

The IGS has the experience, the infrastructure as well as a stated interest to perform a monitoring of tide gauge benchmarks with GNSS. With its global distribution, the IGS network of stations provides a work framework for the TIGA activities. For the specific goals of TIGA this network is further densified by inclusion of non-IGS stations collocated with tide gauges, which, except for the latency criteria, follow the IGS station guidelines. The oversight of the coverage and utility to sea level studies of the network of GNSS stations at tide gauges is provided by the GLOSS Group of Experts.

The aims of the TIGA Working Group are:

1. Compute precise station coordinates and velocities for the GNSS TG stations on a regular, but not necessarily continuous, basis. Newly available stations or published station data of already existing stations will be included into the repeated reprocessing in order to process the largest possible number of stations. The combined solution will have a maximum latency of one year after the reprocessing.
2. Global network of GNSS stations at tide gauges (Fig. 1)
 - Maintain and expand the global GNSS TG network
 - Accept varying latency in GNSS data delivery
 - Promote the establishment of more continuously operating GNSS stations in particular in the southern hemisphere
 - Promote the establishment of links to other sites which may contribute to vertical motion determination, e.g., DORIS, SLR, VLBI, and/or absolute gravity stations.

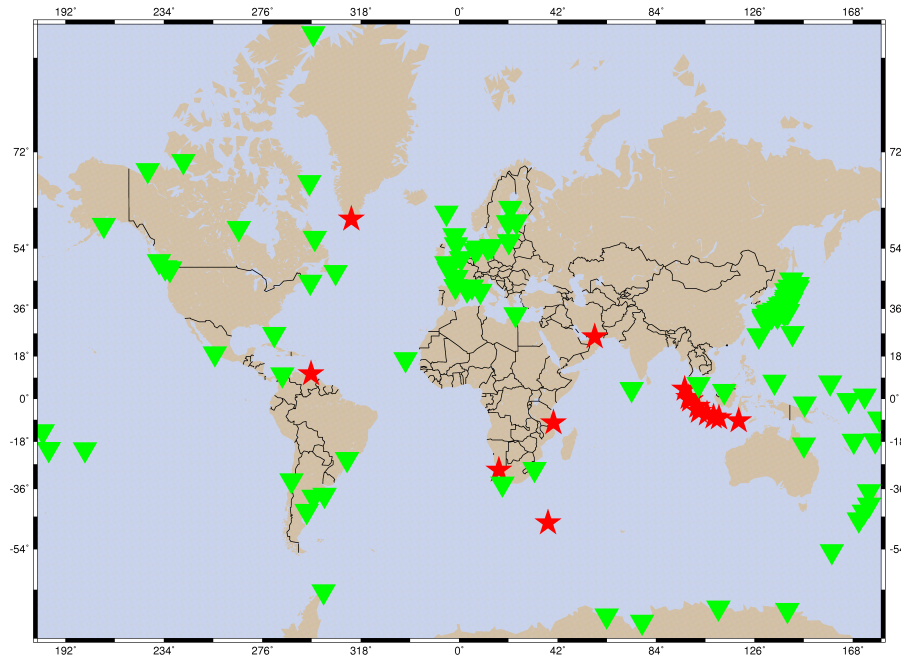

Figure 1: Current TIGA Network. Only stations are accepted as TIGA where, tide gauge, GNSS and leveling data is made public. (green triangles: TIGA Observing Stations, red stars: pending station approval)

3. Contribute to the procedures in which IGS realizes a global reference frame in order to improve its utility for global vertical geodesy. This may involve reprocessing a significant subset of the (past and present) IGS global tracking data set.

GNSS and the other space geodetic techniques are only one tool for the determination of vertical rates. Establishing ties to absolute gravity sites near tide gauges is strongly promoted and results will be evaluated as part of the Working Group activities.

2 TIGA Data Centers

Since 2001 SONEL (www.sone1.org) acts as the primary TIGA data center (TDC); the CDDIS acting as secondary or back-up. SONEL assembles archives and distributes GNSS observations and metadata that can be accessed through the web-based facility, as well as anonymous FTP server. It focuses on GNSS observations from stations at or near tide gauges, but also from the IGS core stations to support each TIGA Analysis Center (TAC) in its processing and reference frame alignment. Nearly 700 station records, representing about 2,100,000 daily RINEX files, are currently archived, out of which 503 station records are (or were, if decommissioned) located at or near a tide gauge. Indeed, only 112 out of

the above 503 stations are formally committed to TIGA. The SONEL database is being expanded and automatic procedures are developed based on mapping and web-based tools to fulfill the above needs. Some of these tools still necessitate refinement or tuning, for instance to cope with the providers specific data latency in order to set accurate alerts.

Last but not least, it is worth noting the formal acknowledgement of SONEL as the GLOSS data assembly center for GNSS stations at or near tide gauges, focusing on GLOSS needs in addition to TIGA requirements. SONEL is encouraged to develop user-friendly web-based tools to support newcomers who are not familiar with the IGS or GNSS practices in order to enable them to commit to TIGA more easily (e.g., DOMES numbers request, submission of a compliant station site-log). Technical support in RINEX conversion and quality control is also important for sea level agencies that are not processing GNSS data for their own purposes and thus may not notice when their observation files are corrupted. In this latter respect collaboration has been established between the GNSS research group at the Royal Observatory of Belgium and the University of La Rochelle.

The role of TIGA network coordinator (TNC) was missing during the TIGA pilot project era (2001–2010) and only filled in 2011. It is related to the TDC activities and has been provided by the same institution running the SONEL data center at the University of La Rochelle. It requires monitoring and reporting on the status of the observation actually made available in the form of daily RINEX files. The role also requires checking the availability and consistency of the associated metadata, which are mostly condensed in the station site-logs.

3 TIGA Analysis Groups

TIGA Analysis Center at the IAG Reference Frame Sub-Commission for Europe (EUREF)

The EUREF solution for TIGA is a combination of up to 18 so-called Local Analysis Center (LAC) contributions. In the first re-processing of the EUREF Permanent Network (EPN) archived observations for the period from GPS week 834 to 1408 have been analyzed. The computation of weekly station coordinate solutions was completed in 2011 and now also the cumulative solution is finalized and is considered a regional densification of ITRF in Europe.

The second EUREF re-processing for TIGA is in the preparation phase. According to the specifications for TIGA Analysis Centers EUREF will apply the IGS-Repro2 analysis options. An important difference to the first EPN re-processing is given by the extension of the analysis of tracking stations from European to global stations. There is no intention by EUREF to calculate satellite orbits, clocks and EOPs. It has been agreed to accept the newest CODE orbits/clocks due to the lack of IGS products of the IGS-Repro2 solution.

The majority of EUREF LACs use the Bernese GNSS Software for data analysis and for the next TIGA re-processing campaign a new version is needed to fulfill the requirements for TIGA analysis centers. This new version has not yet been released and also the mentioned re-processed CODE orbits and clocks that shall be used for the re-processing are not yet available. To date seven LACs confirmed their willingness to participate in the next TIGA re-processing. Some of them will add global tracking stations, where others will re-process a European network only. A preliminary solution of EPN and global stations has been calculated by one LAC and will be presented at the IGS 2012 workshop.

TIGA Analysis Center ULR Consortium (ULR)

The ULR Consortium (ULR) is composed by the University of La Rochelle, and the national mapping agencies of Spain and France. The ULR has carried out several GPS data reanalysis campaigns with an increasing tracking network, an improving processing strategy and the best available models (Wöppelmann et al., 2007, 2009; Santamaría-Gómez et al., 2012). The software used for the GPS data processing is the GAMIT/GLOBK package. Currently, the ULR is processing a global network of 446 stations from which 300 are co-located with a tide gauge (see black dots in Fig. 2). The data included in the reprocessing has been extended from the beginning of precise orbits (1994) to present. To cope with the increased available data, the ULR computing facilities have also been upgraded into a cluster composed by 512 processors and 1.2 TB of memory. ULR is also involved with the reprocessing campaigns of the IGS.

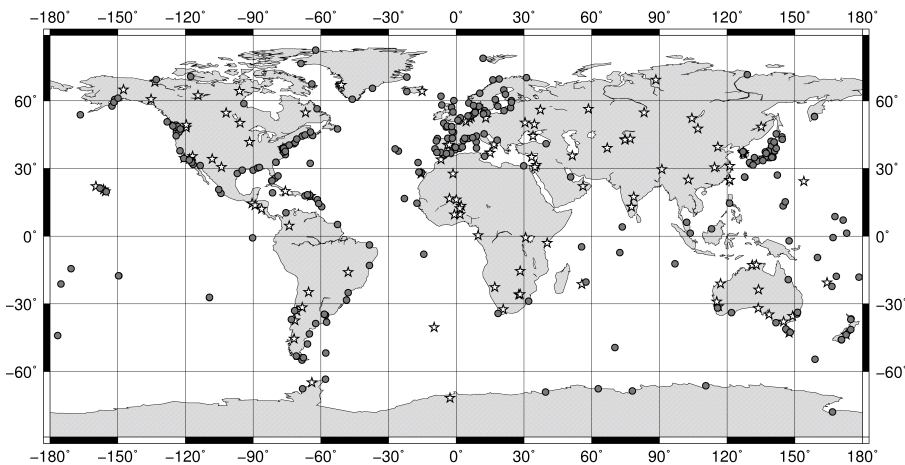

Figure 2: Global GNSS network processed by ULR as a TIGA Analysis Centre

TIGA Analysis Centre at the Deutsches Geodätisches Forschungsinstitut (DGFI)

DGFI participated in the IGS TIGA Pilot Project (2001–2010) by (i) operating continuously observing GPS stations at six tide gauges, and (ii) processing a network of about sixty GNSS sites as a TIGA Analysis Centre (Fig. 3). The processing strategy was based on the double difference approach and included the main standards outlined by the IERS and the IGS. The computed daily free normal equations were combined to get a loosely constrained weekly solution for station positions, in which satellite orbits, satellite clock offsets, and EOPs were fixed to the final weekly IGS products, while a priori positions for all sites were constrained with ± 1 m. These solutions were provided in SINEX format to the TIGA Associated Analysis Centres and to other users through the web site adsc.gfz-potsdam.de/tiga. To guarantee homogeneously computed weekly solutions for the generation of time series of station positions, weekly solutions from January 2000 (GPS week 1043) to October 2006 (GPS week 1399) formerly computed with relative antenna phase centre corrections for the GPS antennae and referring to previous ITRF solutions were reprocessed including absolute phase centre corrections and the IGS05 as reference frame.

The loosely constrained weekly solutions generated by DGFI were further combined in multi-year solutions including those stations operating more than two years. The latest solution of this type (DGF09P01–TIGA) refers to the IGS05, epoch 2000.0 and provides station positions and linear velocities for 57 GNSS sites (Fig. 3). Determination, combination, and solution of the normal equations were carried out with the Bernese GPS Software, V. 5.0 (Dach et al., 2007). Results obtained by DGFI in the frame of TIGA processing are used to determine tide gauge motions with respect to the geocentric reference frame (ITRS/ITRF). These motions are reduced from the tide gauge registrations and the results are compared with the time series derived from satellite altimetry analysis. This procedure is fundamental for the development of further studies related to the vertical datum standardisation at regional and global levels.

Considering the new role of TIGA as an IGS Working Group and with the objective to support the determination of a global vertical reference frame, DGFI decided to extend its computations to a global network including:

- GNSS stations (close or) at tide gauges used for vertical datum definition;
- GNSS stations on insular areas;
- GNSS stations (close or) at those tide gauges with long-time registrations available at the PSMSL (Permanent Service for Mean Sea level) or GLOSS (Global Sea Level Observing System);
- Additional GNSS stations (close or) at tide gauges to make the geographical distribution as homogeneous as possible;
- IGS reference stations for datum definition purposes. In this case, the so-called IGS08 core stations were included.

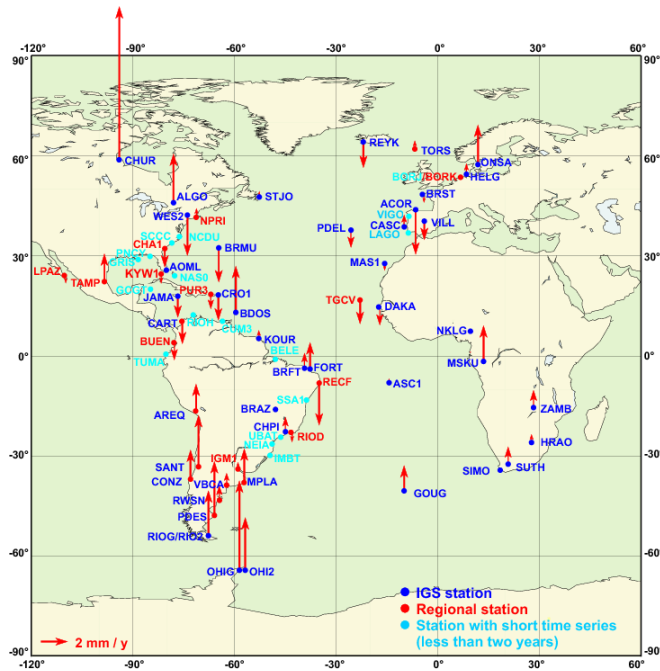

Figure 3: Vertical velocities of the GPS network processed at DGFI within the IGS TIGA Pilot Project between 2000 and 2010.

The processing strategy of this global network is further based on the double difference approach using the Bernese Software V. 5.0 (Dach et al., 2007) and follows the IGS conventions and standards. The main difference with respect to the previously delivered solutions is that daily and weekly SINEX files will include estimates for satellite orbits.

The present activities are concentrated on aligning the processing strategy to the agreements outlined during the TIGA Working Group Meeting held at GLOSS GE XII, on November 11, 2011, in Paris, France. The reprocessing of the proposed global network for the period covered between the GPS weeks 886 (January 1997) and 1668 (December 2011) shall be ready by the end 2012.

4 TIGA Combination

TIGA Combination by Astronomical Institute of the University of Bern (AIUB)

The AIUB is one of the two TIGA Combination Centers. The Bernese GPS Software (Dach et al., 2007) in an extended version is used for the import of the SINEX files generated by

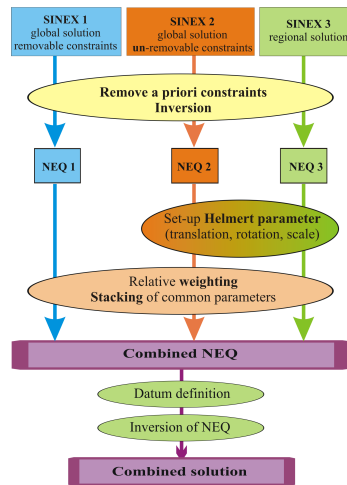

Figure 4: Flowchart of the TIGA combination implemented at AIUB.

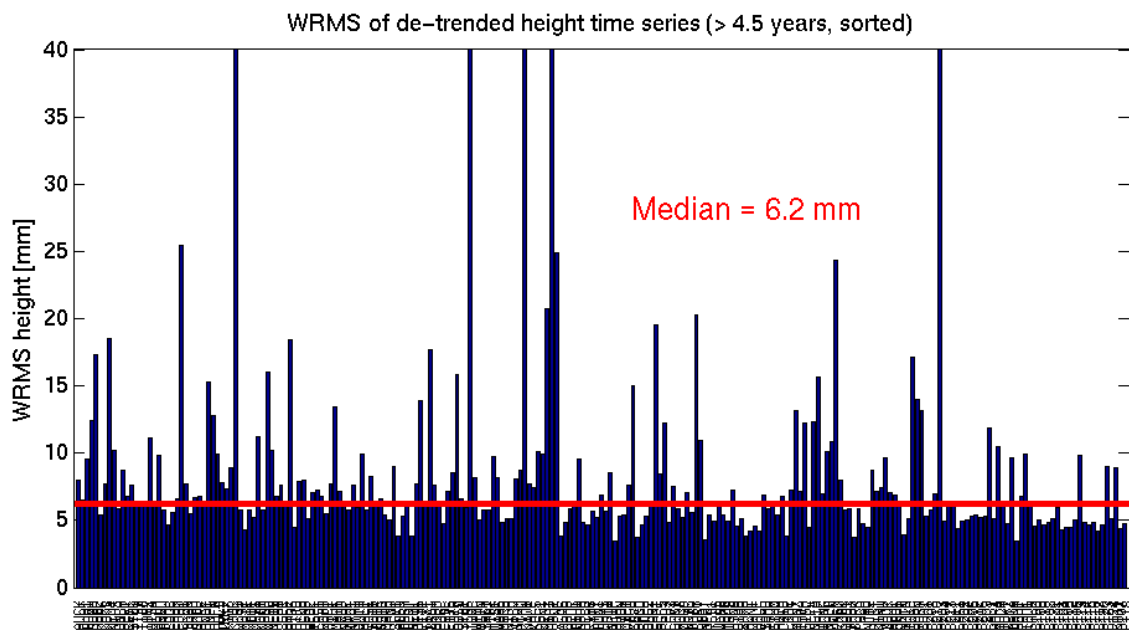

Figure 5: Weighted RMS of weekly station heights after removing the vertical trend. The stations are sorted according to the length of their time series (left side: 11 years; right side: 4.5 years).

the individual TIGA Analysis Centers, as well as for the combination on normal equation level. The flowchart of the TIGA combination is already set up and is shown in Fig. 4.

The SINEX files available from the TIGA Pilot Project have been analyzed so far. Combined weekly solutions have been generated for the time span 1998.0 – 2009.0, i.e., altogether eleven years or 574 weeks. The most important result from the TIGA analysis is the vertical trend of each station. As a quality measure of the vertical trends we computed the weighted RMS of the weekly time series of station heights after removing the trend computed from an 11-year solution. The weighted RMS of the de-trended station height time series is shown in Fig. 5. Only those stations with a time series longer than 4.5 years are considered as the estimation of a reliable trend is not possible with shorter time series. We see that most of the stations are better than a few millimeters only.

TIGA Combination Center University of Luxembourg (UOL)

During 2011 the Geophysics Laboratory of the University of Luxembourg (UOL), was established as one of two IGS TIGA Combination Centers (TCC) within the TIGA Working Group. In its proposal the UOL TCC proposed to use the Tanya combination software developed and used by the IGS GNAAC at Newcastle University (NCL) since the late 1990s (e.g., Davies, 1997; Davies and Blewitt, 2000; Lavallée and Blewitt, 2002; Nurutdinov et al., 2004). The NCL GNAAC produces their weekly combination from the IGS global AC contributions using a free-network approach with outlier detection and an evolving variance co-variance component procedure (Nurutdinov, 2008). Although Tanya serves mainly as the production software at the NCL GNAAC, it has also enabled a number of fundamental science results (e.g., Lavallée and Blewitt, 2002; Blewitt and Clarke, 2003; Lavallée et al., 2010). The latter is of particular relevance for the development and improvement of global geophysical models required in high-precision GNSS processing.

The stochastic properties of coordinate time series have been shown to affect the uncertainties associated with the estimated parameters, most importantly the velocity estimate. The standard method for this is based on maximum likelihood estimation (MLE), and the CATS software (Williams, 2008) is widely used for this purpose within the IGS community. An alternative method can be based on the use of Monte Carlo Markov Chains (MCMC), which also simultaneously provides an uncertainty for the estimated spectral index and the correlations between the parameters. Using MLE, these can only be obtained after the MLE found a solution and the likelihood function was obtained. A comparison of the results from CATS and the MCMC method will be presented at the IGS Workshop 2012.

5 Scientific applications

The GLOSS Implementation Plan (Update 2012) gives a comprehensive overview about the application of TIGA products, primarily estimates of vertical velocities, for different applications. Most prominent are climate applications. To name a few, TIGA provides important input for global sea level rise estimates (Santamaría-Gómez et al., 2012) or radar altimetry calibration (Mitchum et al., 2010). In addition, the TIGA products are worth for the establishment or maintenance of local height or depth datums (Ihde et al., 2007; Sánchez and Bosch, 2009; Wöppelmann et al., 2007), but also e.g., in the estimation of trough flow at straits or in the study of geophysical processes such as the Glacial Isostatic Adjustment (Bouin and Wöppelmann, 2010).

Sea level is estimated to have risen globally at a rate of around 1.7 mm/year over the past century (see Meyssignac and Cazenave, 2012, for an update). To be useful for long-term sea level trend studies, vertical land movements should be estimated with standard errors of one order of magnitude less. In this context, the quality of the estimated vertical GPS velocities at tide gauges has been given considerable attention within the TIGA analysis groups. This quality has clearly increased by applying the latest state-of-the-art models and corrections all over the entire observation span, henceforth supporting the TIGA rationale of regular reanalysis campaigns. For instance, Santamaría-Gómez et al. (2011) show a significant reduced noise content in the GPS position time series compared to the previous solution obtained by Wöppelmann et al. (2009). The nature of the noise remains, however, mostly dominated by a flicker noise-like process. Its source appears elusive and requires further investigation.

Despite the remarkable advances made recently in the reanalysis of GPS data, we are aiming at a level of performance where serious consideration of the terrestrial reference frame and its long-term stability need to be addressed. The stability of the origin and scale of the frame has repeatedly been spotted as one of the main factors limiting the determination of accurate vertical velocities today (Blewitt et al., 2010). A terrestrial reference frame accurate and stable at the sub-millimeter per year level is required. In this respect, Legrand et al. (2010) have underscored the importance of global versus regional GPS data processing. Differences up to 3 mm/year in the vertical velocities were found that strongly affect the geophysical inferences. In addition, Collilieux and Wöppelmann (2011) have investigated how the errors in the rates of the reference frame scale and origin propagate into the sea level change estimates. They conclude with an uncertainty of 0.7 mm/year in the estimates of global sea level change using tide gauges and GPS data in the ITRF2005, likely reduced to 0.5 mm/year with the ITRF2008 (updated study).

Contribution of the BLT AC

F. N. Teferle¹, R. M. Bingley², A. Sowter³, D. Hansen², L. Adamska³, S. D. P. Williams⁴

- ¹ Geophysics Laboratory, University of Luxembourg,
- ² British Isles continuous GNSS Facility (BIGF), University of Nottingham,
- ³ Nottingham Geospatial Institute (formerly Institute of Engineering Surveying and Space Geodesy), University of Nottingham,
- ⁴ National Oceanography Centre, Liverpool

During 2011 the consortium consisting of the NERC British Isles continuous GNSS Facility (BIGF), hosted by the Nottingham Geospatial Institute (NGI) (formerly Institute of Engineering Surveying and Space Geodesy), University of Nottingham and the Geophysics Laboratory (GL), University of Luxembourg, proposed to become the BIGF–University of Luxembourg TIGA (BLT) Analysis Center. Together both institutions have a history of working in the field of monitoring vertical land motions at tide gauge sites in the United Kingdom using a combination of GPS, absolute gravity and persistent scatterer interferometry.

Persistent scatterer interferometry @ TG in the United Kingdom As part of a Natural Environment Research Council SOFI funded project the use of Persistent Scatterer Interferometry (PSI) using ERS1/2 and ENVISAT data was investigated at four TG sites (North Shields, Liverpool, Sheerness and Newlyn) in the United Kingdom. PSI is a powerful technique for measurement and monitoring of vertical land movements (VLM) by the analysis of the time series of especially selected pixels in satellite imaging radar data. Contrary to other geodetic techniques, such as precise leveling and/or continuous GPS, which are used at tide gauge (TG) sites to monitor their stability, PSI is capable of providing estimates over a wide spatial extent. Over the past years, PSI has been successfully applied to the monitoring of urban and rural areas, as well as volcanoes and land slides, providing millimeter–level accuracy.

The application of PSI to coastal areas and to monitoring TG sites has not been well investigated. Furthermore, this application seems not as straightforward as it maybe is suggested from the technique’s other successes. For example, the levels of urbanization and/or vegetation at TG sites, affects the ability of different algorithms to identify the scatterers from the stack of radar images. Ocean tide loading (OTL), a fairly well–known process and modeled effect in GPS analyses, has so far largely been ignored in PSI, but has been reported to introduce significant displacement gradients of more than 3 cm per 100 km. Fig. 6 and Fig. 7 show the regional and local results for North Shields using ENVISAT ASAR data over the period from 2003 to 2008.

We conclude that PSI for sea level studies has two main applications: regional and local. For regional applications, PSI can provide maps of relative changes in land level over a large coastal area. This application is clearly achievable using past satellite missions (ERS

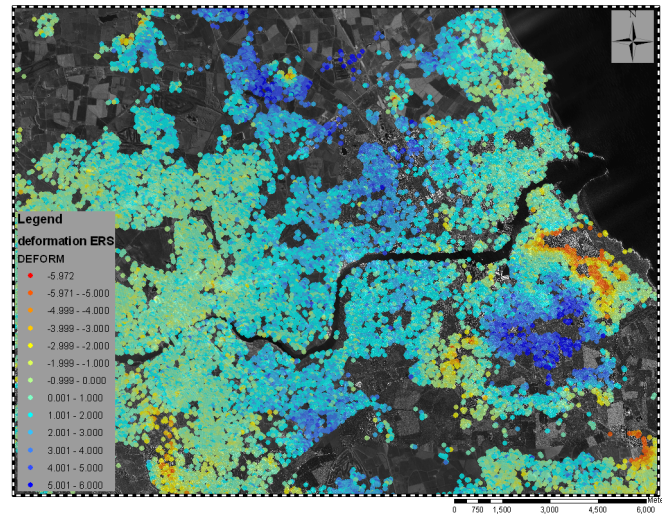

Figure 6: ENVISAT ASAR result for North Shields (2003–2008). TG site with GPS station are depicted as pink dot. Clearly visible are the various areas of relative land uplift and subsidence with respect to the reference scatterer (not shown). The VLM in the region around the TG are shown to be consistently between -2 and $+2$ mm/year (yellow to turquoise).



Figure 7: Persistent scatterer points in the areas around the TG (left) and the nearby Lighthouse (right) where the TG benchmarks are located. The PS points indicate that both areas are stable with respect to each other.

and ENVISAT) and future satellite missions (Sentinel-1), but is reliant on having archived and new data available for a particular site. For local applications, PSI can complement the leveling of benchmark networks. This application is more difficult when using past satellite missions (e.g., ERS and ENVISAT) and future satellite missions (e.g., Sentinel-1), as it is both reliant on having archived and new data available for a particular site but also reliant on obtaining PS points on the structure that supports the tide gauge, e.g. we have had success at the ‘quays’ in Liverpool and North Shields but not on the ‘pier’ at Newlyn or the ‘jetty’ at Sheerness. This application should be more achievable with high-resolution SAR satellites, but this raises the question of data availability for such scientific applications.

References

- Bevis, M., W. Scherer, and M. Merrifield. Technical Issues and Recommendations Related to the Installation of Continuous GPS Stations at Tide Gauges. *Marine Geodesy*, 25 (1):87–99, 2002.
- Blewitt, G., Z. Altamimi, J. Davis, R. Gross, C. Kuo, F. Lemoine, R. Neilan, H. P. Plag, M. Rothacher, C. K. Shum, M. G. Sideris, T. Schöne, P. Tregoning, and S. Zerbini. Geodetic Observations and Global Reference Frame Contributions to Understanding Sea Level Rise and Variability. In: Churchm J., P. L. Woodworth, T. Aarup, S. Wilson (eds.), *Understanding sea level Rise and variability* Wiley–Blackwell, London, pp 256–284, 2010.
- Blewitt, G. and P. J. Clarke. Inversion of Earth’s changing shape to weigh sea level in static equilibrium with surface mass redistribution. *Journal of Geophysical Research*, 2003. doi: 10.1029/2002JB002290.
- Blewitt, G., D. Lavallée, P. J. Clarke, and K. Nurutdinov. A New Global Mode of Earth Deformation: Seasonal Cycle Detected. *Science*, 294:2342–2345, 2001.
- Bouin, M.–N. and G. Wöppelmann. Land motion estimates from GPS at tide gauges: a geophysical evaluation. *Geophys. J. Int.*, 180:193–209, 2010.
- Carter, W. E. (ed.). Report of the Surrey Workshop of the IAPSO Tide Gauge Bench Mark Fixing Committee. Report of a meeting held 13–15 December 1993 at the Institute of Oceanographic Sciences Deacon Laboratory. NOAA Technical Report NOSOES0006, 1994.
- Carter, W. E., D. G. Aubrey, T. F. Baker, C. Boucher, C. LeProvost, D. T. Pugh, W. R. Peltier, M. Zumberge, R. H. Rapp, R. E. Shutz, K. O. Emery, and D. B. Enfield. Geodetic fixing of tide gauge benchmarks. Woods Hole Oceanographic Institution Technical Report, WHOI–89–31, 1989.

- Collilieux, X. and G. Wöppelmann. Global sea level rise and its relation to the terrestrial reference frame definition. *J. Geod.* 85:9–22, 2011.
- Dach, R., U. Hugentobler, P. Fridez, and M. Meindl. *Bernese GPS Software Version 5.0*, 2007.
- Davies, P. *Assembling the IGS Polyhedron; A densified weekly GPS terrestrial reference frame*. Ph.D. Thesis, Newcastle University, 1997.
- Davies, P. and G. Blewitt. Methodology for global geodetic time series estimation: A new tool for geodynamics. *J. Geophys. Res.–Solid Earth*, 105:11083–11100, 2000.
- Douglas, B. C. Global Sea Level Rise. *J. Geophys. Res.*, 96(C4):6981–6992, 1991. doi: 10.1029/91JC00064
- Ihde et al. Conventions for the Definition and Realization of a Conventional Vertical Reference System (CVRS). IAG Inter-Commission Project, ICP1.2 Vertical Reference Frames, 2007.
- Lavallée, D. A. *The Tanya Software*, User Manual. Newcastle University, 2006.
- Lavallée, D. A. and G. Blewitt. Degree-1 Earth deformation from very long baseline interferometry measurements. *Geophysical Research Letters*, 29(20):28/21–24, 2002.
- Lavallée, D. A., P. Moore, P. J. Clarke, E. J. Petrie, T. van Dam, and M. A. King. J2: An evaluation of new estimates from GPS, GRACE, and load models compared to SLR. *Geophys. Res. Lett.*, 37(22), L22403, 2010.
- Legrand, J., N. Bergeot, C. Bruyninx, G. Wöppelmann, M.-N. Bouin, and Z. Altamimi. Impact of regional reference frame definition on geodynamic interpretations. *J. Geodyn.*, 49:116–122, 2010.
- Meyssignac, B., and A. Cazenave. Sea level: a review of present-day and recent-past changes and variability. *J. of Geodyn.*, 58:96–109, 2012.
- Mitchum, G. T., R. S. Nerem, M. A. Merrifield, and R. Gehrels. 20th Century Sea Level Change Estimates From Tide Gauges and Altimeters. In: *Understanding Sea-level Rise and Variability*, Eds. J. A. Church, P. L. Woodworth, T. Aarup and W. S. Wilson. Blackwells Publishing, London, 2010.
- Neilan, R. E., P. A. van Scoy, and P. L. Woodworth (eds.). Workshop on *Methods for Monitoring Sea Level*, IGS Workshop Proceedings, Pasadena, CA, Jet Propulsion Laboratory, 1997.
- Nurutdinov, K. The Newcastle GNAAC Annual Report for 2003–2004. IGS Central Bureau, NASA Jet Propulsion Laboratory Publication, International GPS Service 2003–2004 Technical Reports, 112–115, 2008.

- Nurutdinov, K. et al. The Newcastle GNAAC Annual Report for 2001–2002. IGS Central Bureau, NASA Jet Propulsion Laboratory Publication, International GPS Service 2001–02 Technical Reports, 103–110, 2004.
- Sánchez, L. and W. Bosch. The Role of the TIGA Project in the Unification of Classical Height Systems. In: Drewes H. (Ed.): *Geodetic Reference Systems*, Springer, IAG Symposia, 134:285–290, 2009.
- Santamaría-Gómez, A., M.-N. Bouin, X. Collilieux, and G. Wöppelmann. Correlated errors in GPS position time series: implications for velocity estimates. *J. Geophys. Res.*, 116, B01405, 2011. doi: 10.1029/2010JB007701
- Santamaría-Gómez, A., M.-N. Bouin, and G. Wöppelmann. Improved GPS data analysis strategy for tide gauge benchmark monitoring. In: S. Kenyon et al. (Eds.), *Geodesy for Planet Earth*, International Association of Geodesy Symposia, 136, 2012. doi: 10.1007/978-3-642-20338-1_2
- Schöne, T., N. Schön, and D. Thaller. IGS Tide Gauge Benchmark Monitoring Pilot Project (TIGA): scientific benefits. *J. Geod.* 83:249–261, 2009. doi: 10.1007/s00190-008-0269-y.
- Williams, S. D. P. CATS: GPS coordinate time series analysis software. *GPS Solutions*, 12(2):147–153, 2008.
- Wöppelmann, G., B. Martín Míguez, M.-N. Bouin, and Z. Altamimi. Geocentric sea-level trend estimates from GPS analyses at relevant tide gauges world-wide. *Glob. Plan. Change* 57:396–406, 2007. doi: 10.1016/j.gloplacha.2007.02.002.
- Wöppelmann, G., C. Letretel A. Santamaría, M.-N. Bouin, X. Collilieux, Z. Altamimi, S. D. P. Williams, and B. Martín Míguez. Rates of sea level change over the past century in a geocentric reference frame. *Geophys. Res. Lett.*, 36, L12607, 2009. doi: 10.1029/2009GL038720.

TIGA Working Group Members

- Tilo Schöne (Deutsches GeoForschungsZentrum (GFZ), Germany) (Chair of TIGA-PP)
- Ruth Neilan, IGS Central Bureau, Director (ex officio)
- Philip Woodworth (PSMSL, UK)
- Gary Mitchum (University of South Florida, USA)
- Mark Merrifield (UHSLC, GLOSS, USA)
- Paul Tregoning (Australian National University, Australia)
- Heinz Habrich (Bundesamt für Kartographie und Geodäsie, Germany (Analysis Coordinator of EUREF Permanent Network)), [TAC]

- Laura Sánchez (Deutsches Geodätisches Forschungsinstitut, Germany) [TAC]
- Guy Wöppelmann (University La Rochelle, France) [TAC, TNC, TDC]
- Zhiguo Deng (Deutsches GeoForschungsZentrum (GFZ), Germany) [TAC]
- Minghai Jia (GEOSCIENCE Australia, Australia)
- Matt King (University of Newcastle, UK)
- Daniela Thaller (University of Bern, Switzerland), [TCC]
- F. Norman Teferle (Geophysics Laboratory, University of Luxembourg) [TCC, TAC]
- Richard M. Bingley (British Isles continuous GNSS Facility (BIGF), University of Nottingham) [TAC]
- Carey Noll (CDDIS, Goddard Space Flight Center, NASA) [TDC]
- Jake Griffiths, IGS Analysis Center Coordinator (ex officio)

Former members (till end of 2011):

- Sergei Rudenko (Deutsches GeoForschungsZentrum (GFZ), Germany)
- Jim Ray, past IGS Analysis Center Coordinator

The TIGA Technical Report was compiled by the TIGA Working Group members. Specific individual contributions are marked.

IGS Troposphere Working Group 2011

C. Hackman and S. Byram

United States Naval Observatory
3450 Massachusetts Avenue Northwest
Washington DC 20392 USA
e-mail: christine.hackman@usno.navy.mil
phone: 202 762 1428

1 Introduction

The IGS Troposphere Working Group (IGSTWG) was founded in 1998. In 2011, chairmanship of the WG as well as responsibility for producing IGS Final Troposphere Estimates (IGSFTE) was transferred from the Jet Propulsion Laboratory (JPL, where Dr. Yoaz Bar-Sever had chaired the IGSTWG) to the United States Naval Observatory (USNO).

Dr. Christine Hackman now chairs the IGSTWG. Dr. Sharyl Byram oversees production of the IGSFTEs. Both are part of the GPS Analysis Division (GPSAD) in the Earth Orientation Department at USNO. GPSAD also hosts the USNO IGS Analysis Center.

The IGSTWG comprises approximately 40 actively-confirmed members (cf. Appendix A). A revised charter approved by the IGS Governing Board (GB) at the close of 2011 is shown in Appendix B.

Products : At present, the IGS (via USNO) produces final troposphere estimates only, consisting of total zenith delay (ZPD), N gradient and E gradient spaced at five minute intervals. These are generated for the 300+ stations of the IGS network with three weeks latency and can be downloaded from <ftp://cddis.gsfc.nasa.gov/gps/products/troposphere/zpd>.

2 Activities/Milestones 2011

The first major 2011 task was to transfer generation of IGSFTEs from JPL to USNO. USNO did not have confirmation from IGS that it would be assuming its IGS troposphere roles until early Spring 2011; however, USNO promised the IGS Governing Board at the

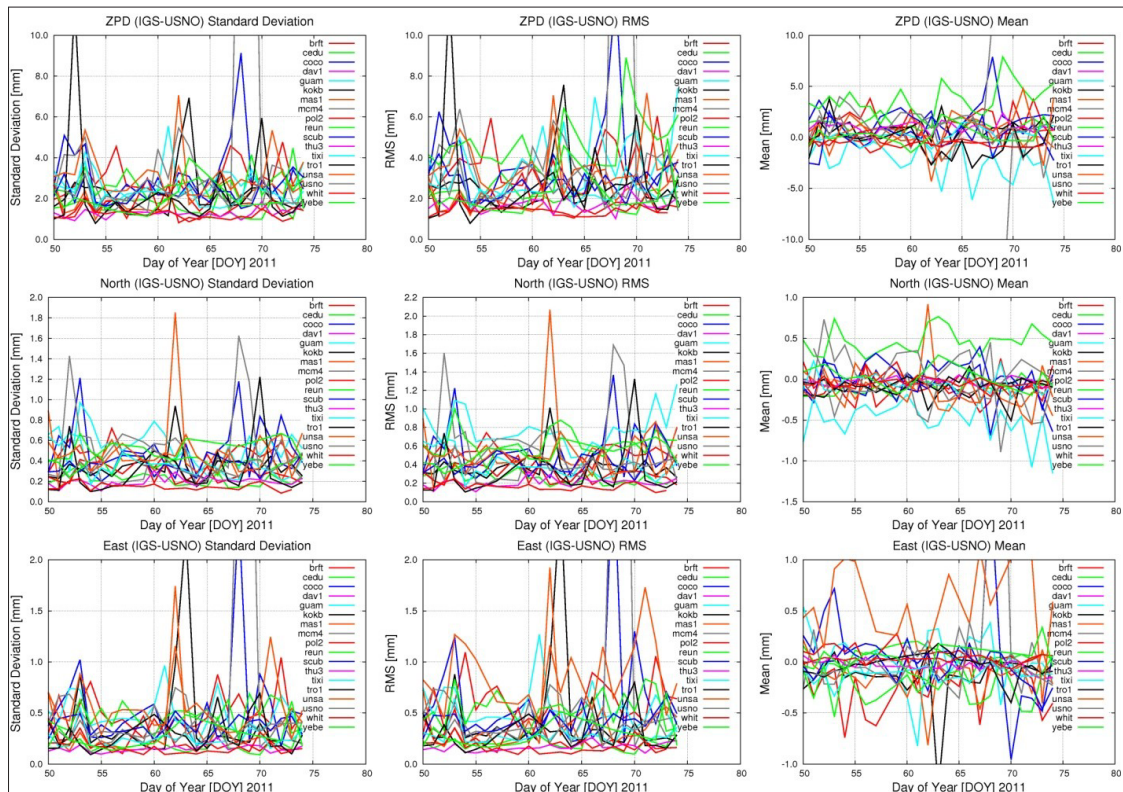

Figure 1: Comparison of USNO test troposphere solutions to existing IGS Final Troposphere estimates, in preparation for operational transition to USNO. ZPD = total zenith troposphere delay. Days of year 50–74 (28 Feb–14 Mar) 2011. From Byram et al. (2011).

Spring 2011 Meeting that it could assume computation duties in July 2011. This, in fact, came to pass, due primarily to the efforts of Dr. Byram (with IT assistance from USNO GPSAD UTGPS manager Mr. Jeffrey Tracey).

Having set up the troposphere estimation routines but prior to the JPL–USNO transfer, Dr. Byram compared several weeks of USNO troposphere estimates for 18 IGS stations to IGSFTEs computed by then–chair JPL. The USNO estimates agreed with existing IGSFTEs with RMSs of 2.95 mm (total vertical zenith delay) and 0.42 mm (both north and east components). Drs. Yoaz Bar–Sever and Urs Hugentobler (IGS GB chair) reviewed the results and agreed that the processing transfer could go forward.

Dr. Byram presented details of her comparison at the ION GNSS 2011 meeting (Section 3/Fig. 1).

The second major 2011 task, performed by Dr. Hackman, was to re–organize the IGSTWG. Dr. Hackman confirmed the continued interest of existing members and recruited new ones,

re-drafted the charter and created initial action plans. She presented progress reports to the IGS GB at the Spring and Fall 2011 meetings. Mr. Robert Kachikyan, JPL, assisted by setting up an email server for the group.

3 Publications

Byram, S., C. Hackman, and J. Tracey. Computation of a High-Precision GPS-Based Troposphere Product by the USNO. *Proc. ION GNSS 2011*, 572–578, 2011.

4 Products, 2011

USNO uses *Bernese GPS Software* (Dach et al., 2007) for producing troposphere estimates whereas the previous producers, JPL, used *GPS Inferred Positioning System* (GIPSY; Webb and Zumbege, 1997). USNO's first priority in assuming troposphere-production duties was to reproduce existing estimates created by JPL, optimizing continuity in the troposphere-delay series over time. As mentioned previously and shown in Fig. 1, this was achieved at millimeter level.

In 2011, JPL produced the IGSFTEs for dates 1 Jan–16 Apr. USNO produced estimates from 17 Apr–31 Dec, contributing 82,000+ 24 h files to the IGS.

5 Plans for 2012

Working group: Dr. Hackman circulated a survey to IGSTWG members in Jan 2012 designed to ascertain what direction they thought the IGSTWG ought to take in terms of research, product quality and new products. The results of this will be discussed and an action plan drafted at the IGSTWG splinter meeting at the IGS 2012 Workshop (Olszytn, Poland).

The IGSTWG will be quite active at the IGS 2012 Workshop, hosting an oral plenary troposphere session, a troposphere poster session, an IGSTWG splinter meeting, and with Dr. Byram presenting a poster on IGSFTE generation. A splinter meeting is planned for the 2012 Fall AGU meeting as well.

Dr. Byram and the IGSTWG plan to participate in IGS Reprocessing Campaign 2 (“Repro 2”). The a priori vision is to produce Repro 2 troposphere estimates with a PPP (Zumbege et al., 1997) technique, as is done now, using Repro 2 orbits, clocks and earth-rotation-parameter estimates.

An on-going comparison between IGSFTEs and troposphere estimates produced by (a) other IGS ACs or (b) other techniques might provide useful information. However, USNO may not have resources to support this, and it is only worth doing if someone is committed to reviewing comparison data. This matter will remain under consideration pending input from interested parties.

Finally: the IGSTWG wishes to update its portions of the IGS website (<http://www.igs.org>), and will cooperate with the website owners as needed to accomplish this.

References

- Dach, R., U. Hugentobler, P. Fridez, M. Meindl (eds). *Bernese GPS Software Version 5.0* (user manual). Astronomical Institute of University of Bern, Bern, Switzerland, 2007.
- Zumberge, J. F., M. B. Heflin, D. C. Jefferson, M. M. Watkins, and F. H. Webb. Precise Point Positioning for the Efficient and Robust Analysis of GPS Data from Large Networks. *J. Geophys. Res.*, 102(B3):5005–17, 1997.
- Webb, F. H. and J. F. Zumberge (eds.). An Introduction to GIPSY/OASIS-II: Precision Software for the Analysis of Data from the Global Positioning System. JPL internal publication D-11088, Jet Propulsion Laboratory, Pasadena, California, 1997.

A IGS Troposphere Working Group Members

Name	Institution	Country	email
Amirkhani, Mohammad	Islamic Azad Univ. Tehran	Iran	m.amirkhani2008@gmail.com
Bar-Sever, Yoaz	JPL	USA	yoaz.bar-sever@jpl.nasa.gov
Bevis, Mike	OSU	USA	mbevis@osu.edu
Bosser, Pierre	ENSG/DPTS	France	pierre.bosser@ensg.eu
Braun, John	UCAR	USA	braunj@ucar.edu
Byram, Sharyl	USNO	USA	sharyl.byram@usno.navy.mil
Byun, Sung	JPL	USA	sung.h.byun@jpl.nasa.gov
Calori, Andrea	Univ. Roma "La Sapienza"	Italy	calori@mendoza-conicet.gob.ar
Chen, Junping	Shanghai Astronomical Observatory	China	junping.chen@shao.ac.cn
Colosimo, Gabriele	Univ. Roma "La Sapienza"	Italy	gabriele.colosimo@uniroma1.it
Crespi, Mattia	Univ. Roma "La Sapienza"	Italy	mattia.crespi@uniroma1.it
Dick, Galina	GFZ	Germany	dick@gfz-potsdam.de
Dousa, Jan	GOP	Czech	jan.dousa@pecny.cz
Drummond, Paul	Trimble	New Zealand	paul_drummond@trimble.com
Ghoddousi-Fard, Reza	Natural Resources Canada	Canada	rghoddou@nrcan.gc.ca
Guerova, Guergana	Univ. Sofia	Bulgaria	guerova@phys.uni-sofia.bg
Gutman, Seth	NOAA	USA	seth.i.gutman@noaa.gov
Hackman, Christine	USNO	USA	christine.hackman@usno.navy.mil
Heinkelmann, Robert	Deutsches Geodätisches Forschungsinstitut	Germany	heinkelmann@dgfi.badw.de
Herring, Tom	MIT	USA	tah@mit.edu
Hilla, Steve	NGS/NOAA	USA	steve.hilla@noaa.gov
Langley, Richard	Univ. New Brunswick	Canada	lang@unb.ca
Leighton, Jon	3vGeomatics	Canada/UK	jonny2vests@gmail.com
Moeller, Gregor	TU Wien	Austria	gregor.moeller@tuwien.ac.at
Moore, Angelyn	JPL	USA	angelyn.w.moore@jpl.nasa.gov
Negusini, Monia	Inst. Radioastronomy (IRA); National Inst. Astrophysics (INAF)	Italy	negusini@ira.inaf.it
Nordman, Maaria	Finnish Geodetic Inst.	Finland	maaria.nordman@fgi.fi
Pacione, Rosa	ASI/CGS	Italy	rosa.pacione@e-geos.it
Penna, Nigel	Univ. Newcastle	UK	nigel.penna@newcastle.ac.uk
Perosanz, Felix	CNES	France	felix.perosanz@cnes.fr
Pottiaux, Eric	Royal Obs Belgium	Belgium	eric.pottiaux@observatoire.be
Prikryl, Paul	Communications Research Centre, Canada	Canada	paul.prikryl@crc.gc.ca
Rocken, Chris	GPS Solutions	USA	rocken@gps-solutions.com
Santos, Marcelo	Univ. New Brunswick	Canada	msantos@unb.ca
Schaer, Stefan	swisstopo	Switzerland	stefan.schaer@aiub.unibe.ch
Schön, Steffen	Inst. Erdmessung, Leibniz Uni Hannover	Germany	schoen@mbox.ife.uni-hannover.de
Sguerso, Domenico	Lab. Geodesy, Geomatics, GIS; Univ. Genoa	Italy	domenico.sguerso@unige.it
Tracey, Jeffrey	USNO	USA	jeffrey.tracey@usno.navy.mil
van der Marel, Hans	TU Delft	Netherlands	H.vanderMarel@tudelft.nl
Wang, Junhong	UCAR/NCAR	USA	junhong@ucar.edu
XuZong-qiu, Liaoning	TU	China	zongqiuxu@gmail.com
Zhang, Shoujian	Wuhan Univ.	China	shjzhangwhu@gmail.com

B IGS Troposphere Working Group Charter

IGS TROPOSPHERE WORKING GROUP CHARTER

GNSS can make important contributions to meteorology, climatology and other environmental disciplines through its ability to estimate troposphere parameters. Along with the continued contributions made by the collection and analysis of ground-based receiver measurements, the past decade has also seen new contributions made by space-based GNSS receivers, e.g., those on the COSMIC/FORMOSAT mission [1]. The IGS therefore continues to sanction the existence of a Troposphere Working Group (TWG).

The primary goals of the IGS TWG are to:

- Assess/improve the accuracy/precision of IGS GNSS-based troposphere estimates.
- Improve the usability of IGS troposphere estimates.
 - Confer with outside agencies interested in the use of IGS products.
 - Assess which new estimates should be added as "official" IGS products, and which, if any, official troposphere product sets should be discontinued.
- Provide and maintain expertise in troposphere-estimate techniques, issues and applications.

Science background

The primary troposphere products generated from ground-based GNSS data are estimates of total zenith path delay and north/east troposphere gradient. Ancillary measurements of surface pressure and temperature allow the extraction of precipitable water vapor from the total zenith path delay.

Water vapor, a key element in the hydrological cycle, is an important atmosphere greenhouse gas. Monitoring long-term changes in its content and distribution is essential for studying climate change. The inhomogeneous and highly variable distribution of the atmospheric water vapor also makes it a key input to weather forecasting.

Water vapor distribution is incompletely observed by conventional systems such as radiosondes and remote sensing. However, ground- and space-based GNSS techniques provide complementary coverage of this quantity. Ground-based GNSS observations produce continuous estimates of vertically integrated water vapor content with high temporal resolution over a global distribution of land-based locations; coverage is limited over the oceans (where there is no land). Conversely, water vapor can be estimated from space-borne GNSS receivers using ray tracing techniques, in which case solutions with high vertical resolution (laterally integrated over few hundred kilometers) and good oceanic/land coverage are obtained; these solutions however are discontinuous in geographic location and time.

Be it resolved that the IGS troposphere WG will:

- Support those IGS analysis centers providing official IGS troposphere products.
- Increase awareness/usage of IGS troposphere products by members of the atmospheric, meteorology and climate-change communities. Solicit the input and involvement of such agencies.
- Create new IGS troposphere products as needed (as determined by consultation with the potential user community).
- Determine the uncertainty of IGS troposphere estimates through comparison of solutions with those obtained from independent techniques, or through other means as appropriate.
- Promote synergy between space-based and ground-based GNSS techniques through interaction with researchers in both fields.

References:

- [1] Schreiner, W., C. Rocken, S. Sokolovskiy, S. Syndergaard and D. Hunt, Estimates of the precision of GPS radio occultations from the COSMIC/FORMOSAT-3 mission, *GRL*, 34, L04808, doi:10.1029/2006GL027557, 2007.
- [2] Teke, K., J. Böhm, T. Nilsson, H. Schuh, P. Steigenberger, R. Dach, R. Heinkelmann, P. Willis, R. Haas, S. García-Espada, T. Hobiger, R. Ichikawa and S. Shimizu, Multi-technique comparison of troposphere zenith delays and gradients during CONT08, *J Geod*, 85:395–413, doi: 10.1007/s00190-010-0434-y, 2011.

Clock Products Working Group

K. Senior

U.S. Naval Research Laboratory
4555 Overlook Ave SW; Washington DC 20375
ken.senior@nrl.navy.mil; Phone: +1 202 767 2043

In 2011 the IGS Clock Products Working Group (CPWG) migrated the IGS Rapid and Final clock products to new reference timescales based on a new version 2.0 algorithm developed at the U.S. Naval Research Lab (NRL). The new algorithm was implemented primarily to improve upon the longer term stability of the legacy v1.0 timescale. The improvements include changes to clock modeling, the UTC alignment (steering), as well as to changes to the clock weighting approach used. Additional states were also added to the Kalman filter to model up to two fixed period harmonics in order to better compensate contributions from the GPS satellite clocks. The algorithm is fully automated requiring no regular user intervention. A brief description of the algorithm improvements is given below along with its current performance status.

1 Basic Model for all Clocks

The basic clock model used for each clock in the new version 2.0 IGS timescale (both ground and GPS satellite clocks) includes the clock's time (or phase), its first derivative

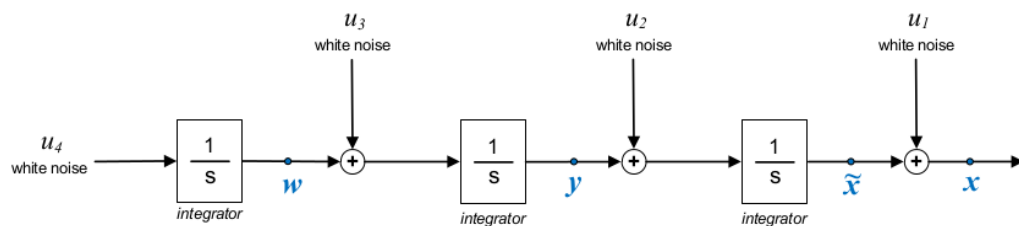

Figure 1: The basic clock model used in the IGS v2.0 timescale includes the clock's phase x , frequency y , and drift w , each driven by integrated white noises (random walks) as well as an additional phase state \tilde{x} , necessary to model also a pure white phase noise. Up to two pure harmonics may also be included. Each of the phase, frequency, and drift states are modelled stochastically by an independent random walk, random walk phase (RWPH), random walk frequency (RWFR), and random walk drift (RWDR).

(frequency), and its second derivative (drift), each modeled stochastically with an independent random walk as shown in Figure 1. An additional phase state \tilde{x} is included to model a pure white phase noise and to couple to optionally specified pure fixed period harmonics as described below.

The perfect integrator model of Figure 1 (or subcomponents of it) has been used to model well the behavior of most clocks dating back to the 80s (Jones and Tryon, 1983). Although the legacy version of the IGS timescale employed only a two state model of a clock's behavior the new version has employed the new full version.

2 Additional Pure Harmonic States

It has been well investigated that significant harmonics are present throughout the GPS constellation clocks nominally at periods of 12-h, 6-h, 4-h and 3-h with amplitudes up to 2 ns (c.f., Senior et al., 2008; Montenbruck et al., 2011). Figure 2 shows the amplitude spectra of the GPS constellation clocks where all spectra were calculated individually for each clock and then averaged over the constellation in the Fourier domain. As the figure shows the pervasiveness and prominence of particularly the 12-h and 6-h harmonics in most GPS satellite clocks dictates the need to compensate or model these variations explicitly in the timescale filter. For this reason four additional states have been included in the v2.0 IGS timescale filter to compensate up to two fixed period harmonics which can be specified per clock. Two states are required for each harmonic, one in-phase and one quadrature, and are coupled only to a single phase state as shown in Figure 1 above.

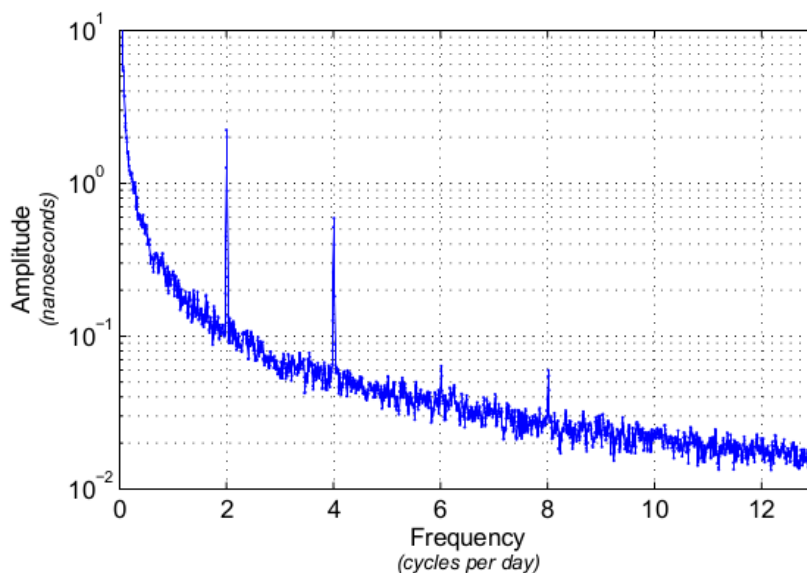

Figure 2: Amplitude spectrum for the GPS constellation clocks. Spectra were calculated individually for each satellite and averaged over the entire constellation of clocks.

3 Timescale Constraints

The geodetic estimation technique necessarily produces phase offset observations of each clock that are rank deficient in the sense that each clock's phase must be estimated with respect to the phase of some other reference clock, or timescale. The goal of a timescale algorithm is to generate a reference (paper) clock that is both stable but also independent of any single clock, or equivalently to produce better estimates of each individual clock's behavior; these are equivalent since for example estimating perfectly an individual clock is equivalent to generating a perfect reference. The rank deficiency of the phase observations represents an observability problem in estimating the individual clocks and is typically addressed by introducing additional constraints into the estimation process, typically an additional assumption(s) about how the ensemble behaves on average.

Since each type of random input-random walk phase (RWPH), random walk frequency (RWFR), and random walk drift (RWDR) represents from an ensemble of clocks a separate ensemble of noises, three separate recursive weighted conditions are imposed to constrain the ensemble timescale solution (Stein, 1993):

$$\begin{aligned}
 \sum_{i=1}^N a_i(t) \cdot (x_i(t) - x_i(t|t - \delta)) &= 0 \\
 \sum_{i=1}^N b_i(t) \cdot (y_i(t) - y_i(t|t - \delta)) &= 0 \\
 \sum_{i=1}^N c_i(t) \cdot (w_i(t) - w_i(t|t - \delta)) &= 0
 \end{aligned} \tag{1}$$

where the notation, $(t|t + \delta)$, denotes a prediction of the given quantity to epoch t from some previous epoch $t + \delta$. These constraints impose that the weighted sum of the differences between the clock's true states and their predictions be zero on weighted (ensemble) average. Provided the correctness of the model each clock's state differs from its prediction exactly by its random noise inputs. Thus, the optimal weights a_i , b_i , and c_i are chosen inversely to the variances of the noises contributing to each state, that is, inversely to the level of each random walk noise input. This selection of weighting has the effect of normalizing each clock's contribution to the noise of the ensemble and will typically result in a reference ensemble timescale more stable than its constituents. The additional weights also have the benefit of effectively optimizing separately the different random walk type noise contributions—RWPH, RWFR, and RWDR—perturbing each of the states x , y , and w , respectively.

An example showing the benefits of multiple clock weighting is depicted in a simulation example below (Figure 3). In the example twelve clocks were simulated from three classes of clocks, each class differentiated by differing levels of RWPH and RWFR noise. The relative levels of each simulated clock's noise are represented in the figure using the Hadamard

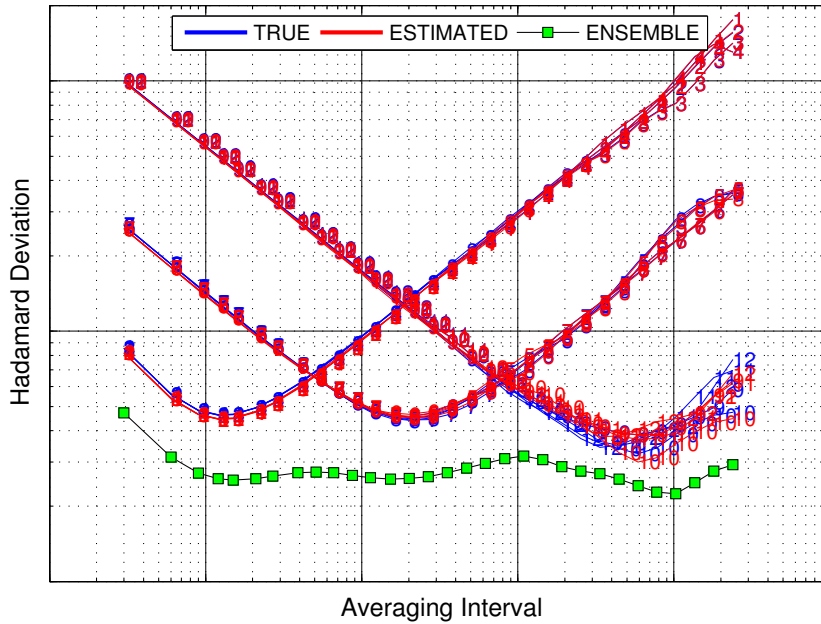

Figure 3: Timescale frequency stability results as measured by the Hadamard deviation statistic for a twelve clock simulation example based on three classes of clocks, where each class is differentiated by a relative different level of RWPH and RWFR noise.

deviation statistic where the simulated true values (blue) are plotted on a log–log scale plot of the Hadamard deviation versus averaging interval; a smaller deviation indicates lower noise at that averaging interval and the slope indicates the type of noise. Note that a slope of $-1/2$ in the plot is consistent with RWPH noise whereas a slope of $+1/2$ is consistent with RWFR. The simulated measurements were then processed in the v2.0 timescale filter with per clock weights specified inversely according to their levels of noise type. The plot also shows (green) the resulting noise of the filtered timescale. As the figure shows the ensemble timescale is more stable than any of the constituent clocks and optimally utilizes each class accordingly.

4 UTC (steering) Alignment

The steering control approach used in v2.0 to align the timescale to UTC is based on a Linear Quadratic Gaussian (LQG) drift steering control in which the amount of steering is determined via a weighted quadratic cost functional that relatively penalizes deviations of the timescale from UTC versus the relative amount of control effort (drift steering) applied. This approach is the same as that used in the legacy timescale. However, while both the legacy and v2.0 use an LQG steering control approach the UTC datum is handled

differently in the new version. In the legacy version the timescale was steered to GPS Time. The new version utilizes a weighted average of calibrated UTC(k) realizations as well as GPS Time, where the weighting is determined relative to the noise characteristics of each input, similar to the timescale clock weighting.

A method for the determination of IGS station calibration biases was determined by (Senior et al., 2004). Using information from the BIPM Circular T publication the method allows for a determination of the station clock bias offset of an IGS station clock from a collocated UTC(k) at the 1 ns level provided that the clock driving the IGS station is stable by a fixed offset relative to UTC(k) at that level. As of 2009 when the CPWG last reported on the status of the collocated stations there was sufficient timing laboratory participation in the IGS to include between five and ten IGS UTC(k) stations of sufficient quality. However, the calibration algorithm has not yet been implemented operationally in v2.0. Currently, only USN3, AMC2, and GPS Time are included as UTC steering references. These stations were included because their pseudorange data and therefore their geodetic estimates are already adjusted to compensate their UTC calibration offsets.

It is a pending CPWG item to include additional UTC(k) references.

5 Timescale Outputs

The timescale filter output includes states (from four to eight in number) and covariances for each clock relative to the ensemble timescale as well as numerous debugging and clock status information outputs. The IGS product files are re-aligned to the resulting timescale using the phase estimates from the filter in the following way. In order to avoid impacting the raw clock-clock information represented in the ACC combination clocks, the IGS clock products are not replaced directly with the phase estimates from the timescale filter. Instead, the clock measurements $z_i^r(t_k)$ that are *output* from the ACC combination and that are subsequently *input* to the timescale filter are re-aligned to a new set of measurements $z_i^e(t_k)$ relative to the ensemble timescale according to the calculation,

$$z_i^e(t_k) \triangleq z_i^r(t_k) + \text{median}_i\{z_i^r(t_k) - \hat{x}_i^e(t_k)\} \quad (2)$$

where $\hat{x}_i^e(t_k)$ are the phase estimates of each clock relative to the ensemble as determined in the timescale filter. While this retains additional measurement noise in the re-aligned products as compared to the phase estimates themselves it has the added benefit of remaining unchanged any relative clock-clock differences in the re-alignment, i.e.,

$$z_i^e(t_k) - z_j^e(t_k) = z_i^r(t_k) - z_j^r(t_k) \quad (3)$$

for any two clocks i and j . Thus, the timescale re-alignment does not impact the use of the newly align clocks in any navigation solution that uses the products.

Clock products of both the IGS Final and Rapid lines have been re-aligned to the IGS v2.0 timescales as described above, available as before in both SP3 and Clock RINEX formats. Additional timescale re-alignment information is also provided in the clock summary files as before with only one new modification that individual clock weighting now reflects multiple weights per clock. A sample of the addition made to each clock summary files by the timescale re-alignment is shown below in the Appendix A.

New timescale combination plots have also been developed to accompany the usual timescale processing outputs and may be found at <https://goby.nrl.navy.mil/IGStime/igrt.php> and <https://goby.nrl.navy.mil/IGStime/igrt.php> under the “plots_monthly” sub-directory; note that only monthly plots are currently available. Appendix B contains several samples of various plots now included.

Figure 9 shows a sample filter state/sigma output for the IGS BRUX station clock over the month of May 2012. In the plot the clock’s phase estimates including harmonics (black), phase without harmonics (gray) state, frequency state (red), and drift state (blue) are plotted on separate scales along with accompanying sigmas (middle panel) and respective weights (bottom panel), all referenced to the new timescale. The legend of each plot shows any polynomials removed from the respective series for plotting as well as any phase or frequency breaks detected by the filter; for example, a frequency break was clearly detected (with lag) on 11 May in the plot shown

Figure 10 shows a sample frequency stability plot in which the Hadamard deviations of the highest weighted clocks are shown. Since each clock now has four weights in the combination all four weights are now shown in the legend. Changes to the clock combination summary files also now include the multiple weights per clock.

Figure 11 shows an example (AMC2) of another new plot recently added late in 2011 at ACC request showing the phase measurements of each clock relative to the timescale as gleaned from the measurement re-alignment described above in Equation 2. These “data vs timescale” phase-only plots more accurately reflect the timescale re-alignment actually made in the IGS product files for the reasons described above. Also, in the event that a clock has recently been added or reset within the filter its estimates may not have yet reached steady-state. Although the filter sigmas will indicate this condition these additional plots have been added for observing or monitoring clock behavior during such states.

6 Additional Features

The implementation of the v2.0 algorithm is a U-D Kalman filter that is fully automated, requiring no additional user input once the filter has been started. A new feature of the v2.0 algorithm is its ability to adaptively update the clock noise parameters corresponding to the random walks. Whenever a clock is first introduced into the timescale it’s entered with

zero weights and its state and covariance are initialized using a quadratic fit procedure that reduces the otherwise large initial uncertainties of its covariance. Values for its clock model noise parameters are also initially determined automatically according to the following. The clock's RWPH level is determined relative to another stable clock using 1 day of data and using the Hadamard deviation statistic (Hutsell, 1995). Its RWFR and RWDR levels are initially set high and depend on the RWPH level determined. The adaptive filter mechanism subsequently adjusts the noise parameters adaptively utilizing the filter's innovation sequence (pre-fit residuals).

Other necessary practical features of a fully automated timescale include the ability to introduce new clocks into the timescale filter (or remove older ones) without unduly affecting the performance of the timescale. Also, the ability to respond to bad data or to a discrete change in the states of a clock as might for example occur during a station equipment change or upgrade is also necessary. These additional features have been implemented in the new v2.0 timescale.

7 Current Status of IGS Time Scales

Figure 4 summarizes the current overall phase offset status of the IGS Rapid (IGRT) and Final (IGST) timescales as compared against GPS Time and UTC from late 2010 through July 2012, utilizing information from the BIPM Circular T publication. The plot clearly shows an overall UTC alignment improvement as of the transition to version 2.0 though some remaining instabilities in the Rapid timescale are occasionally present. Although the IGS products did not transition until Spring 2011 the plot shows v2.0 data beginning at Jan 1, 2010 where the new timescale was run for this longer period before the transition.

Table 1 below shows the overall comparison of the tie to UTC before and after the transition to v2.0. The Final products now show a very tight relationship to UTC better than 3 ns over the period.

Table 1: Mean and Standard Deviation of the Rapid (IGRT) and Final (IGST) IGS timescales relative to UTC before and after the transition to v2.0.

	Legacy Mean \pm STD	v2.0 Mean \pm STD
IGST – UTC	-6.9 ± 13.1	-2.2 ± 2.7
IGRT – UTC	-6.3 ± 13.7	-4.5 ± 7.9

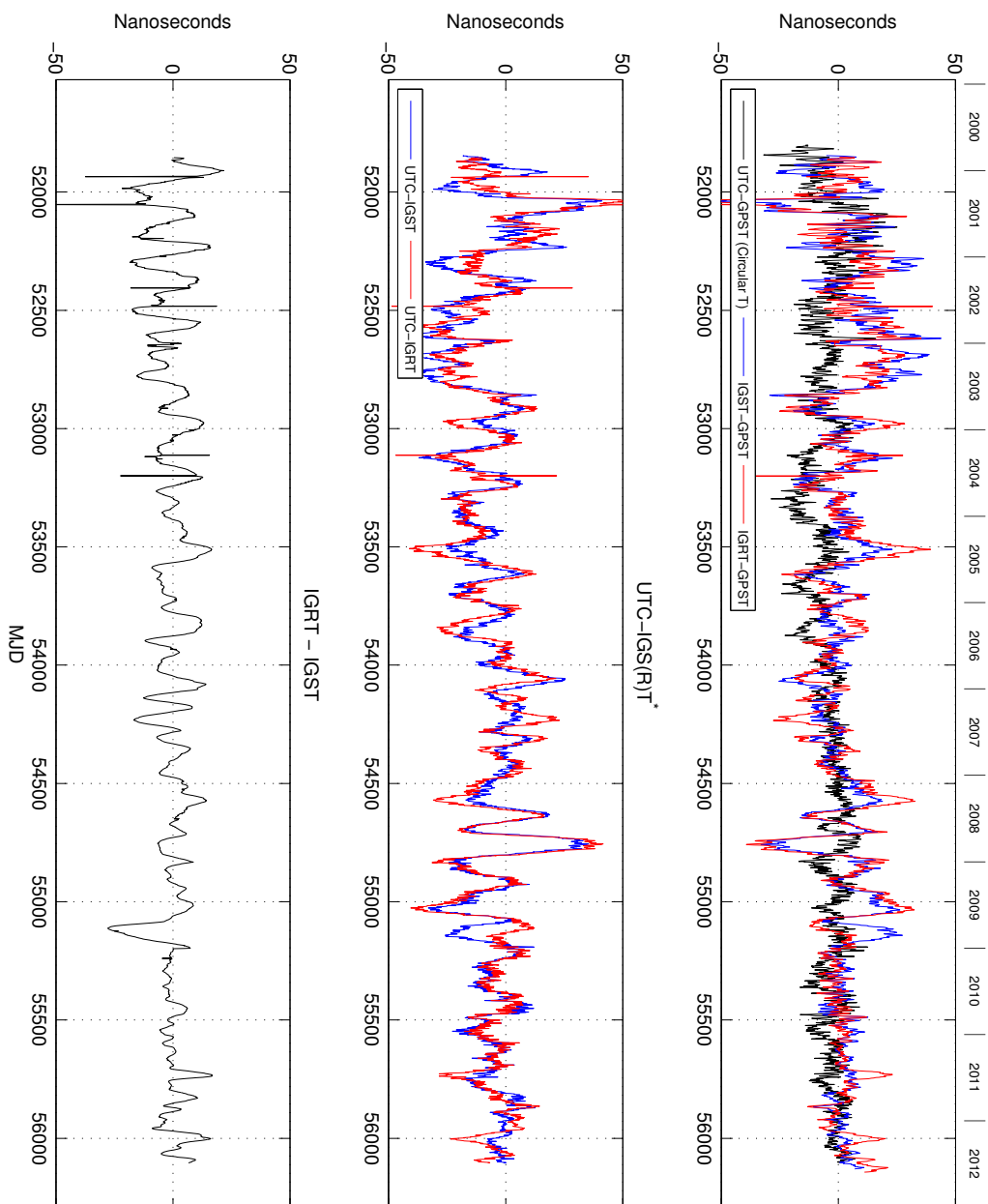

Figure 4: IGS Timescales measured against GPS Time and UTC. Note that data on this plot from the new v2.0 timescale begins Jan 1, 2010 through the products were not transitioned until Spring 2011.

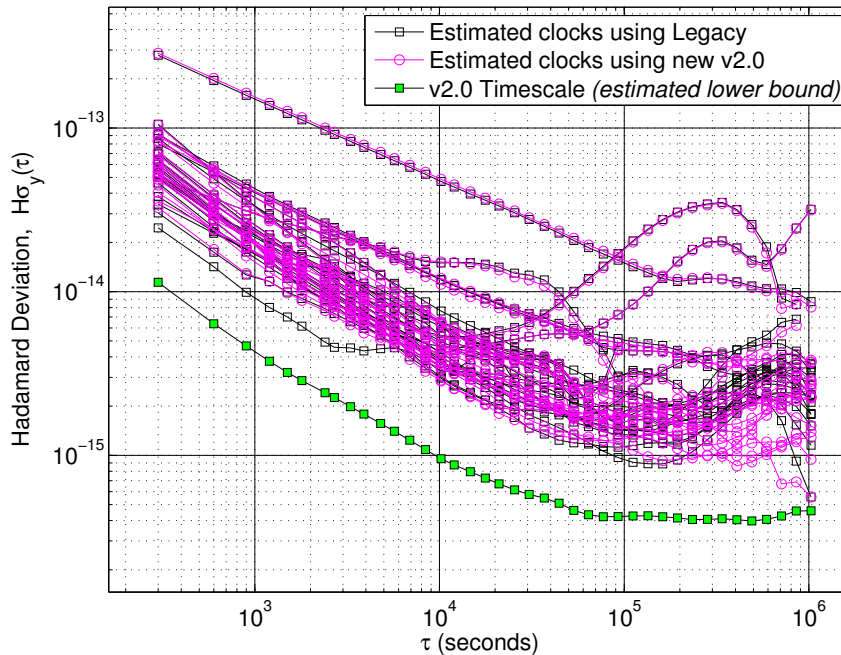

Figure 5: Instabilities (Hadamard deviation) of the most stable IGS clocks relative to the legacy (black) and new v2.0 (red) IGS timescales calculated over the first three months of 2011. Also shown is a lower-bound estimate of the resulting timescale assuming the validity of the phase estimates and the weights used during the period shown. This is a lower bound estimate of the timescale not an estimate of the timescale realized.

Figure 5 shows the frequency stability performance plot of the new v2.0 timescale compared with the legacy version as measured by the Hadamard deviation statistic. The statistics shown were calculated using IGS Final data over the first three months of 2011 and only the most stable clocks over the period are plotted. As may be gleaned by the banding of the clock estimates from each the old (black) and the new (red) versions the new version 2.0 algorithm shows improved stability over the longer term averaging intervals as desired. It's also clear that for shorter averaging intervals there's essentially no difference between the old and new versions consistent with the effectively equivalent short-term weighting constraints in both versions (inverse of RWPH levels).

As a measure of the performance consistency over time of the v2.0 timescales a histogram of the number of clocks having frequency stability as measured by the Hadamard deviation of the (internal) phase estimates better than $3 \cdot 10^{-15}$ at an averaging interval of 21,600 s plotted daily since 2011 is shown in Figure 6 below. As the figure shows there is generally uniform consistency over time of the performance of the products with average numbers of clocks have such stability being 16.6 ± 3 and 12.9 ± 3 for IGST and IGRT, respectively. However there are sporadic days over this period in which the number of such stabilities drops below five clocks. Because these "internal" measures of stability depend on the

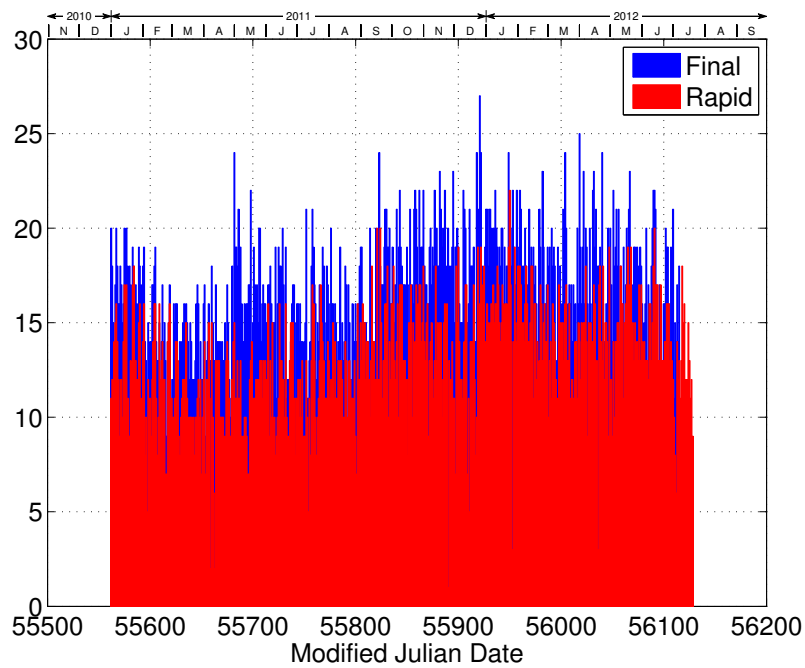

Figure 6: Histogram of the daily number of clocks in the IGS Final and Rapid timescale filters having phase estimate stabilities better than $3 \cdot 10^{-15}$ at $\tau = 21,600$ s as measured by the Hadamard deviation statistic.

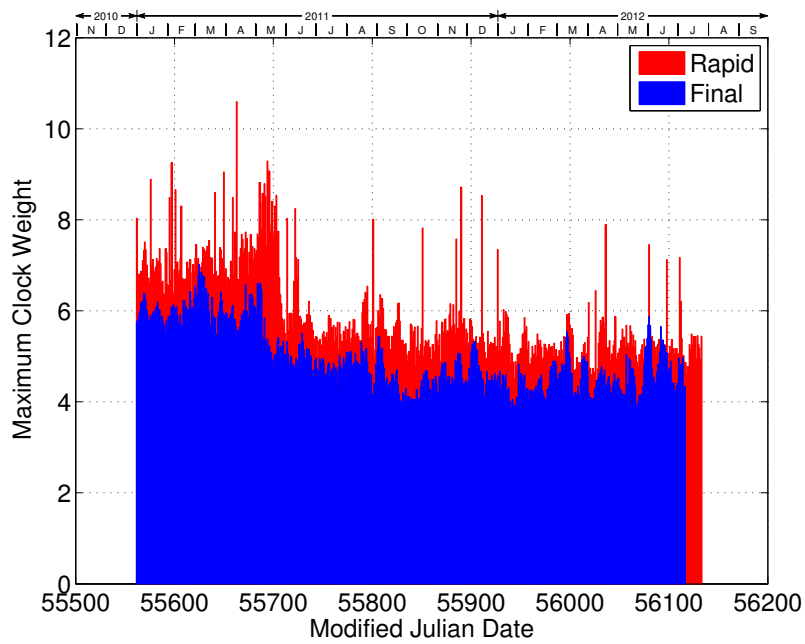

Figure 7: Maximum daily a weight (in %) per clock for the v2.0 IGS Final and Rapid timescales since 2011.

relative clock weights assigned to each clock the maximum a weight (see Equation 1) for each clock is also plotted over the same period in Figure 7.

As detailed above the addition of new fixed period harmonic states to the timescale filter was made in order better compensate the GPS constellation clock errors. Harmonics at frequencies of 2.003 and 4.006 cycles/day are estimated for each of the GPS constellation clocks in both the Rapid and Final timescales. Figure 8 below shows each of the two phase state estimates for PRN 25 versus IGST over a one week period in May 2012. The black series shows the phase state that includes the influence of the harmonics while the gray series shows the other phase state that is estimated without their influence. The magnitude of the difference between the black and gray series demonstrates both the need for estimating these harmonics as well as the effectiveness of the filter in isolating them.

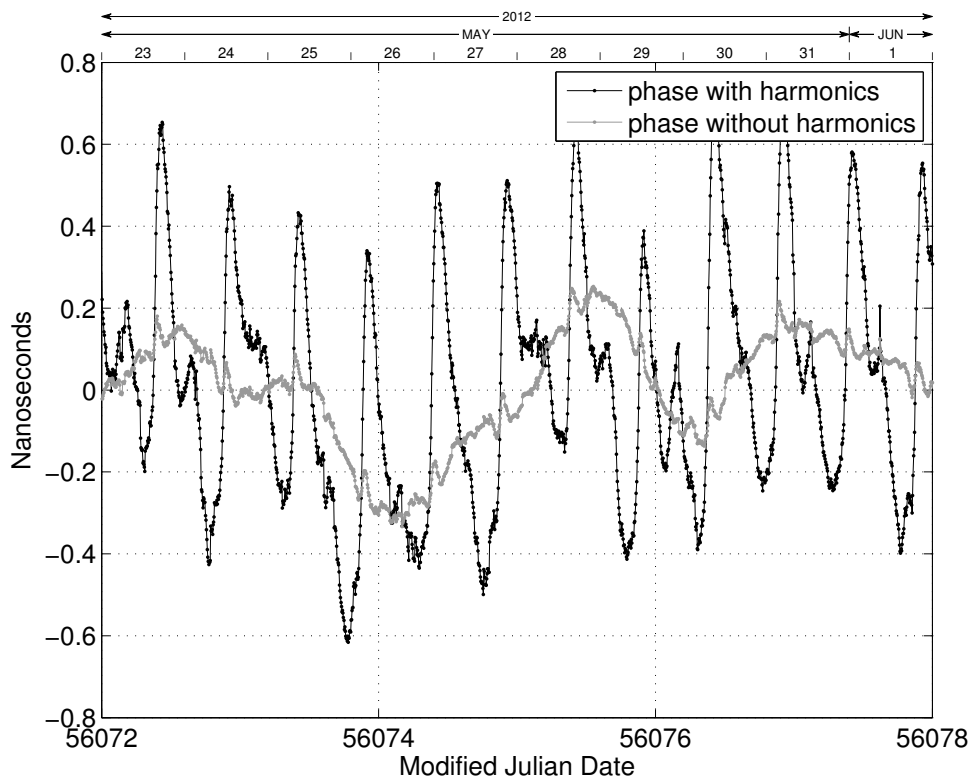

Figure 8: Timescale filter phase estimates of PRN 25 versus the IGS Final timescale IGST over the one week period 25 May through 31 May 2012. The black series shows the timescale phase state with harmonics while the gray series shows the phase minus the harmonics. An overall quadratic was removed from both series for plotting.

References

- Hutsell, S. T.; 1995. Relating the hadamard variance to MCS Kalman filter clock estimation. *Proc. of the 27th Annual Precise Time and Time Interval (PTTI) Applications and Planning Meeting*, p. 293, San Diego, Calif, USA, December 1995.
- Kouba J. and T. Springer; 2001. New IGS station and satellite clock combination. *GPS Solutions*, 4(4):31–36. doi: 10.1007/PL00012863.
- Jones J and P. V. Tryon; 1983. Estimating time from atomic clocks. *Journal of Research of the National Bureau of Standards*, 88(1):17–24.
- Montenbruck O., U. Hugentobler, R. Dach, P. Steigenberger, and A. Hauschild; 2011. Apparent clock variations of the Block IIF–1 (SVN62) GPS satellite. *GPS Solutions*, 16(3):303–313. doi: 10.1007/s10291-011-0232-x.
- Senior K., P. Koppang, and J. Ray; 2003. Developing an IGS time scale. *IEEE Trans Ultrason Ferroelectr Freq Control*, 50:585–593.
- Senior K., G. Petit, and J. Ray; 2004. Comparison of instrumental and empirical station timing biases for a set of Ashtech Z12T GPS receivers. *Proc. 18th European Frequency and Time Forum EFTF 2004*, Guildford, UK, 4–7, April, 2004.
- Senior K., J. Ray, and R. Beard; 2008. Characterization of periodic variations in the GPS satellite clocks. *GPS Solutions*, 12(3):211–225. doi: 10.1007/s10291-008-0089-9.
- Stein, S. R.; 1993. Advances in time–scale algorithms. *Proc. of the 24th Annual Precise Time and Time Interval (PTTI) Applications and Planning Meeting*, pp. 289–303, Greenbelt, Maryland, USA, December 1993.

A Sample of New Combinationa Clock Summary

Sample of New v2.0 IGS Timescale Filter Additions to the Combination Clock Summary Files:

RESULTS OF TIME SCALE COMBINATION:

	STABILITY RESULTS FROM IGS CLOCK ENSEMBLE								HADAMARD 300s	DEVIATION 3600s	AT TAU = 21600s
	NREPO	NBEPO	NFRQ BRKS	NEPO USED	MEAN WGT1 (%)	MEAN WGT2 (%)	MEAN WGT3 (%)	MEAN WGT4 (%)			
NISU	288	288	0	288	6.63	9.95	0.51	0.51	8.94e-15	4.08e-15	2.62e-15
BRUS	288	288	0	288	4.55	7.13	8.70	8.70	9.78e-15	7.07e-15	2.13e-15
BREW	288	288	0	288	4.54	7.10	0.67	0.67	1.04e-14	4.44e-15	1.63e-15
AMC2	288	288	0	288	3.73	4.77	5.16	5.16	1.15e-14	5.53e-15	9.16e-16
DRAO	288	287	1	288	3.73	4.77	9.97	9.97	1.13e-14	5.13e-15	4.72e-15
NLIB	288	288	0	288	3.72	4.76	7.97	7.97	1.07e-14	7.40e-15	3.61e-15
NPLD	287	286	1	287	3.71	4.73	1.24	1.24	-	-	-
USNO	288	288	0	288	3.62	4.49	0.86	0.86	1.01e-14	5.12e-15	1.87e-15
YELL	288	287	1	288	3.56	4.36	9.31	9.31	7.83e-15	4.95e-15	2.08e-15
WSRT	288	288	0	288	3.53	4.27	9.97	9.97	6.14e-15	5.73e-15	2.58e-15
STJO	288	288	0	288	3.49	4.19	5.57	5.57	7.52e-15	5.86e-15	2.55e-15
SPTO	288	288	1	288	3.24	3.59	3.97	3.97	8.20e-15	4.52e-15	2.65e-15
WES2	288	288	0	288	3.11	3.32	0.65	0.65	7.18e-15	5.83e-15	1.43e-14
NRC1	288	288	0	288	3.00	3.09	1.14	1.14	8.10e-15	8.88e-15	1.90e-15
USN3	288	288	0	288	2.95	2.97	1.53	1.53	1.71e-14	6.35e-15	1.31e-15
GPST	288	287	1	288	2.90	2.89	0.17	0.17	7.68e-15	4.47e-15	9.57e-16
CHUR	288	288	1	288	2.67	2.45	2.44	2.44	1.06e-14	7.81e-15	5.05e-15
HOB2	288	287	1	288	2.61	2.32	0.11	0.11	3.94e-14	1.70e-14	3.30e-15
KOKB	288	288	0	288	2.57	2.27	3.31	3.31	1.35e-14	1.24e-14	5.00e-15
TWTF	288	288	0	288	2.41	1.98	2.10	2.10	1.16e-14	1.39e-14	3.17e-15
NYAL	288	288	0	288	2.22	1.69	0.19	0.19	1.23e-14	2.36e-14	3.26e-14
NYA1	288	288	0	288	2.03	1.41	0.17	0.17	1.20e-14	2.33e-14	3.21e-14
BRFT	288	288	0	288	1.90	1.24	0.56	0.56	1.74e-14	1.95e-14	8.67e-15
KHAJ	288	288	0	288	1.88	1.21	0.56	0.56	1.74e-14	2.17e-14	1.74e-14
GODE	288	284	2	288	1.73	1.02	0.11	0.11	1.52e-13	4.70e-14	4.09e-14
NOT1	288	288	0	288	1.66	0.94	0.37	0.37	1.44e-14	1.35e-14	5.84e-15
USUD	288	288	0	288	1.50	0.77	0.05	0.05	8.28e-14	2.30e-14	3.75e-15
MDVJ	288	287	1	288	1.47	0.74	1.21	1.21	2.50e-14	5.82e-15	6.25e-15
MATE	288	288	1	288	1.35	0.62	1.05	1.05	1.65e-14	1.21e-14	2.59e-14
PIE1	288	287	1	288	1.33	0.60	1.92	1.92	2.97e-14	1.34e-14	3.98e-15
ALGO	288	288	1	288	1.01	0.35	0.01	0.01	2.29e-14	9.17e-15	2.80e-15
G14	288	288	0	288	0.45	0.34	0.10	0.10	4.65e-13	5.63e-14	2.34e-14
CRO1	285	285	0	285	0.91	0.28	1.50	1.50	-	-	-
G23	288	288	0	288	0.51	0.27	2.50	2.50	4.38e-13	5.35e-14	9.98e-15
G02	288	288	0	288	0.51	0.26	0.46	0.46	4.60e-13	4.27e-14	1.55e-14
G11	288	288	0	288	0.40	0.25	0.02	0.02	5.95e-13	5.81e-14	4.78e-14
IRKJ	283	280	1	283	0.81	0.23	3.43	3.43	-	-	-
G13	288	288	0	288	0.47	0.23	0.26	0.26	4.57e-13	6.08e-14	4.02e-14
G17	287	287	0	287	0.43	0.20	0.01	0.01	-	-	-
G16	288	287	0	288	0.48	0.18	2.85	2.85	5.67e-13	7.15e-14	2.90e-14
G20	288	288	0	288	0.38	0.18	4.17	4.17	5.77e-13	6.13e-14	1.57e-14
G19	288	287	0	288	0.47	0.18	0.82	0.82	5.32e-13	6.49e-14	4.43e-14
G18	288	288	0	288	0.30	0.17	0.54	0.54	7.92e-13	8.85e-14	2.52e-14
HRAO	288	288	0	288	0.67	0.15	0.10	0.10	7.60e-14	2.93e-14	4.63e-14
PTBB	288	288	0	288	0.67	0.15	0.56	0.56	1.58e-13	6.46e-14	2.60e-14
MAR6	288	288	0	288	0.62	0.13	0.00	0.00	1.59e-13	6.57e-14	3.05e-14
G07	275	275	0	275	0.42	0.13	0.00	0.00	-	-	-
G22	288	288	0	288	0.37	0.12	0.00	0.00	4.80e-13	5.51e-14	1.22e-14

Senior: Clock Products Working Group

G26	288	288	0	288	0.42	0.11	0.31	0.31	2.93e-13	1.30e-13	6.36e-14
G29	288	288	0	288	0.40	0.10	0.31	0.31	3.18e-13	1.17e-13	6.19e-14
PRDS	288	288	0	288	0.51	0.09	0.09	0.09	2.00e-13	7.15e-14	2.46e-14
G04	288	288	0	288	0.35	0.09	0.19	0.19	3.29e-13	1.15e-13	5.94e-14
G05	288	288	0	288	0.33	0.08	0.01	0.01	1.69e-13	5.49e-14	1.19e-13
TLSE	288	288	0	288	0.42	0.06	0.19	0.19	2.88e-13	1.12e-13	2.02e-14
BOR1	287	287	0	287	0.35	0.04	0.04	0.04	-	-	-
PIE1	288	287	1	288	1.33	0.60	1.92	1.92	2.97e-14	1.34e-14	3.98e-15
PRDS	288	288	0	288	0.51	0.09	0.09	0.09	2.00e-13	7.15e-14	2.46e-14
SPTO	288	288	1	288	3.24	3.59	3.97	3.97	8.20e-15	4.52e-15	2.65e-15
STJO	288	288	0	288	3.49	4.19	5.57	5.57	7.52e-15	5.86e-15	2.55e-15
SYOG	288	288	0	0	0.00	0.00	0.00	0.00	6.88e-13	2.13e-13	1.71e-13
THTI	216	161	29	0	0.00	0.00	0.00	0.00	-	-	-
TIDB	288	287	1	0	0.00	0.00	0.00	0.00	7.39e-14	2.39e-14	8.39e-15
TLSE	288	288	0	288	0.42	0.06	0.19	0.19	2.88e-13	1.12e-13	2.02e-14
TWTF	288	288	0	288	2.41	1.98	2.10	2.10	1.16e-14	1.39e-14	3.17e-15
USNO	288	288	0	288	3.62	4.49	0.86	0.86	1.01e-14	5.12e-15	1.87e-15
WAB2	0	0	0	0	0.00	0.00	0.00	0.00	-	-	-
WES2	288	288	0	288	3.11	3.32	0.65	0.65	7.18e-15	5.83e-15	1.43e-14
WSRT	288	288	0	288	3.53	4.27	9.97	9.97	6.14e-15	5.73e-15	2.58e-15
YELL	288	287	1	288	3.56	4.36	9.31	9.31	7.83e-15	4.95e-15	2.08e-15
GPST	288	287	1	288	2.90	2.89	0.17	0.17	7.68e-15	4.47e-15	9.57e-16
WROC	288	243	19	0	0.00	0.00	0.00	0.00	3.35e-12	1.15e-12	1.13e-12
PTBB	288	288	0	288	0.67	0.15	0.56	0.56	1.58e-13	6.46e-14	2.60e-14
SFER	0	0	0	0	0.00	0.00	0.00	0.00	-	-	-
STR1	288	288	0	0	0.00	0.00	0.00	0.00	6.05e-13	2.16e-13	3.86e-14
SYDN	0	0	0	0	0.00	0.00	0.00	0.00	-	-	-
USN3	288	288	0	288	2.95	2.97	1.53	1.53	1.71e-14	6.35e-15	1.31e-15
USUD	288	288	0	288	1.50	0.77	0.05	0.05	8.28e-14	2.30e-14	3.75e-15
ZIMM	287	68	146	0	0.00	0.00	0.00	0.00	-	-	-
YEBE	0	0	0	0	0.00	0.00	0.00	0.00	-	-	-
WHIT	288	288	2	0	0.00	0.00	0.00	0.00	5.07e-13	5.38e-13	3.64e-13
ALBH	287	48	167	0	0.00	0.00	0.00	0.00	-	-	-
BREW	288	288	0	288	4.54	7.10	0.67	0.67	1.04e-14	4.44e-15	1.63e-15
HOB2	288	287	1	288	2.61	2.32	0.11	0.11	3.94e-14	1.70e-14	3.30e-15
MEDI	287	285	1	0	0.00	0.00	0.00	0.00	-	-	-
NISU	288	288	0	288	6.63	9.95	0.51	0.51	8.94e-15	4.08e-15	2.62e-15
NPLD	287	286	1	287	3.71	4.73	1.24	1.24	-	-	-
TNML	288	280	5	0	0.00	0.00	0.00	0.00	3.26e-13	1.28e-13	1.19e-13
TSKB	288	288	0	0	0.00	0.00	0.00	0.00	8.94e-13	2.22e-13	1.05e-13
CEDU	287	46	168	0	0.00	0.00	0.00	0.00	-	-	-
GMAS	288	275	8	0	0.00	0.00	0.00	0.00	1.00e-12	3.29e-13	1.14e-13
OUS2	287	48	170	0	0.00	0.00	0.00	0.00	-	-	-
MAD2	0	0	0	0	0.00	0.00	0.00	0.00	-	-	-
IENG	0	0	0	0	0.00	0.00	0.00	0.00	-	-	-
IRKT	0	0	0	0	0.00	0.00	0.00	0.00	-	-	-
DAEJ	287	204	48	0	0.00	0.00	0.00	0.00	-	-	-
TOW2	288	288	0	0	0.00	0.00	0.00	0.00	4.10e-13	1.16e-13	1.53e-13
-----+-----											
STEERS APPLIED TO TIME SCALE:									9.23e-23	9.47e-23	3.04e-22
-----+-----											
MOST STABLE CLOCKS:									WSRT	NISU	NISU
-----+-----											

B Sample of Plots

Figure 9, page 234

Sample plotting output of the v2.0 timescale filter states/sigmas for the IGS site BRUX. The plot shows the four base states, sigmas, and weights for the clock over a one month period.

Figure 10, page 234

Sample combination stability plot showing the frequency stability of the highest weighted clocks in the IGS timescale for the period 1 May to 31 May, 2012.

Figure 11, page 234

Sample “data vs timescale” plot showing the timescale input phase data for the clock at AMC2 referenced to the timescale IGST for May 2012. These phase “data” plots differ from the phase estimates as they include measurement noise but also since a clock may not be in steady-state within the filter because the clock is new or has undergone a reset.

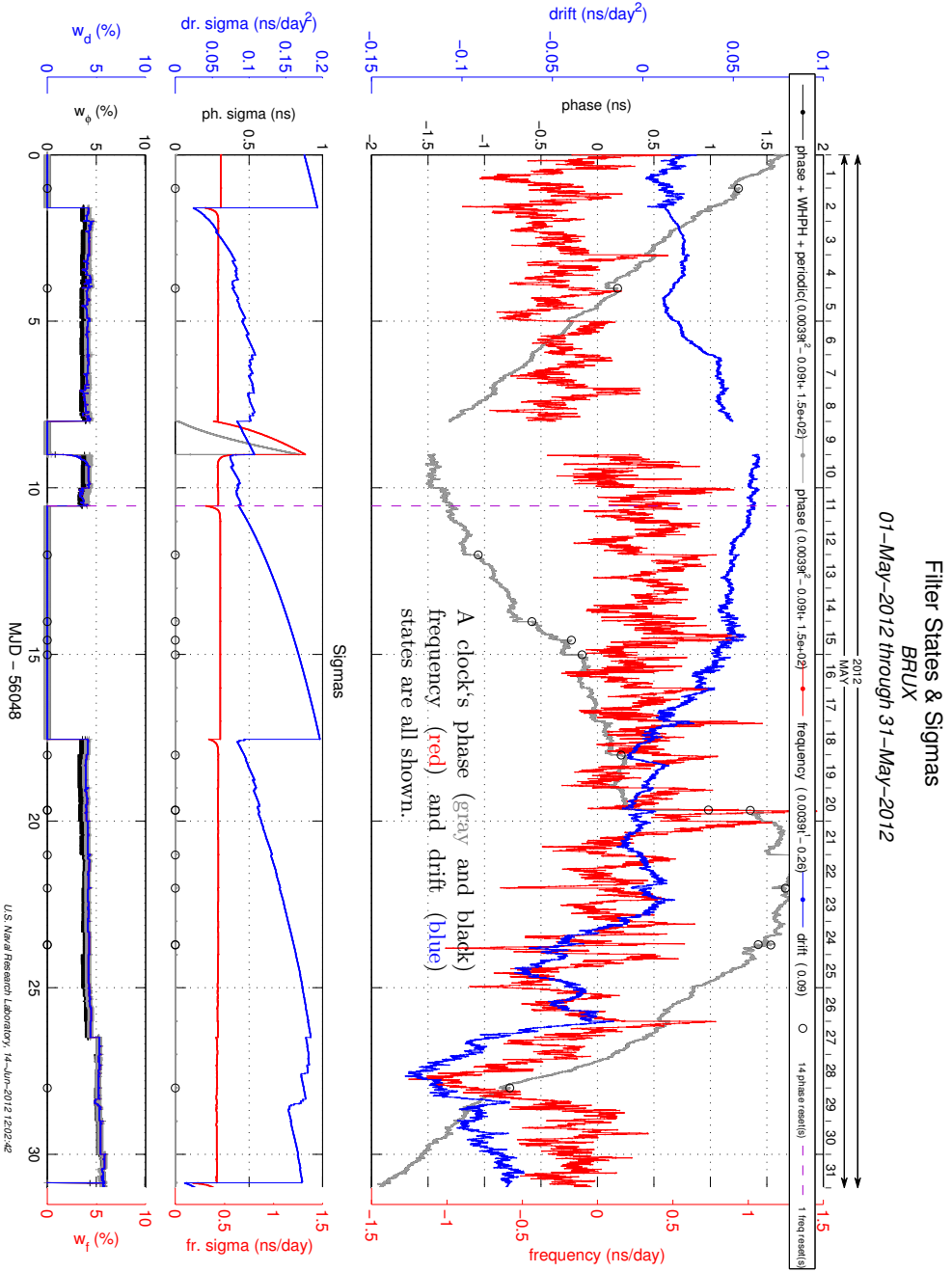

Figure 9: Sample plotting output of the v2.0 timescale filter states/sigmas for the IGS site BRUX. The plot shows the four base states, sigmas, and weights for the clock over a one month period. The black series correspond to the phase (including harmonics), the gray the phase without harmonics, the red series correspond to frequency and blue to drift. The legend also indicates any polynomials removed for plotting and/or phase or frequency breaks detected.

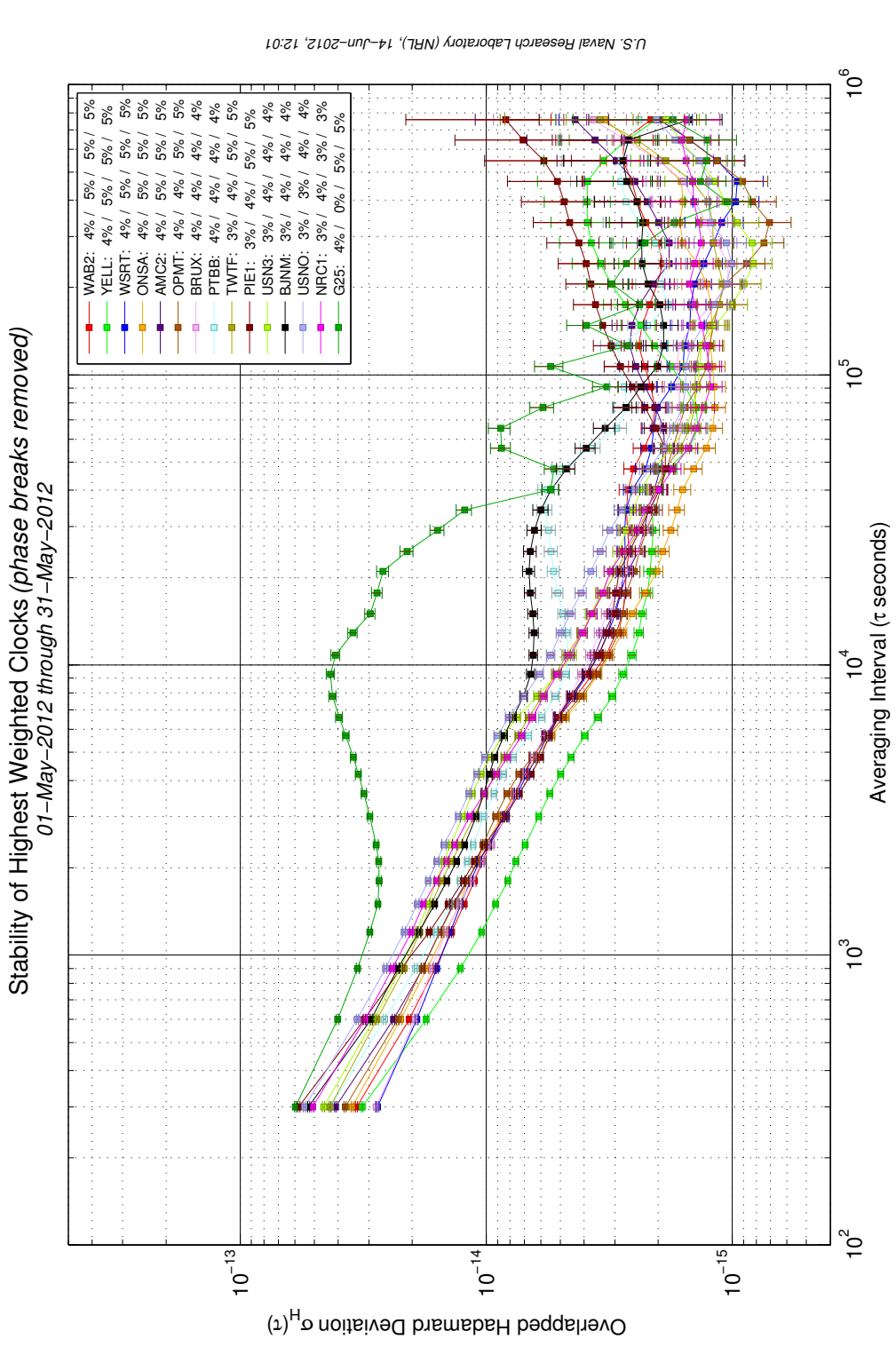

Figure 10: Sample combination stability plot showing the frequency stability of the highest weighted clocks in the IGS timescale for the period 1 May to 31 May, 2012. The a , b , c , and d weights for each clock are shown in the legend.

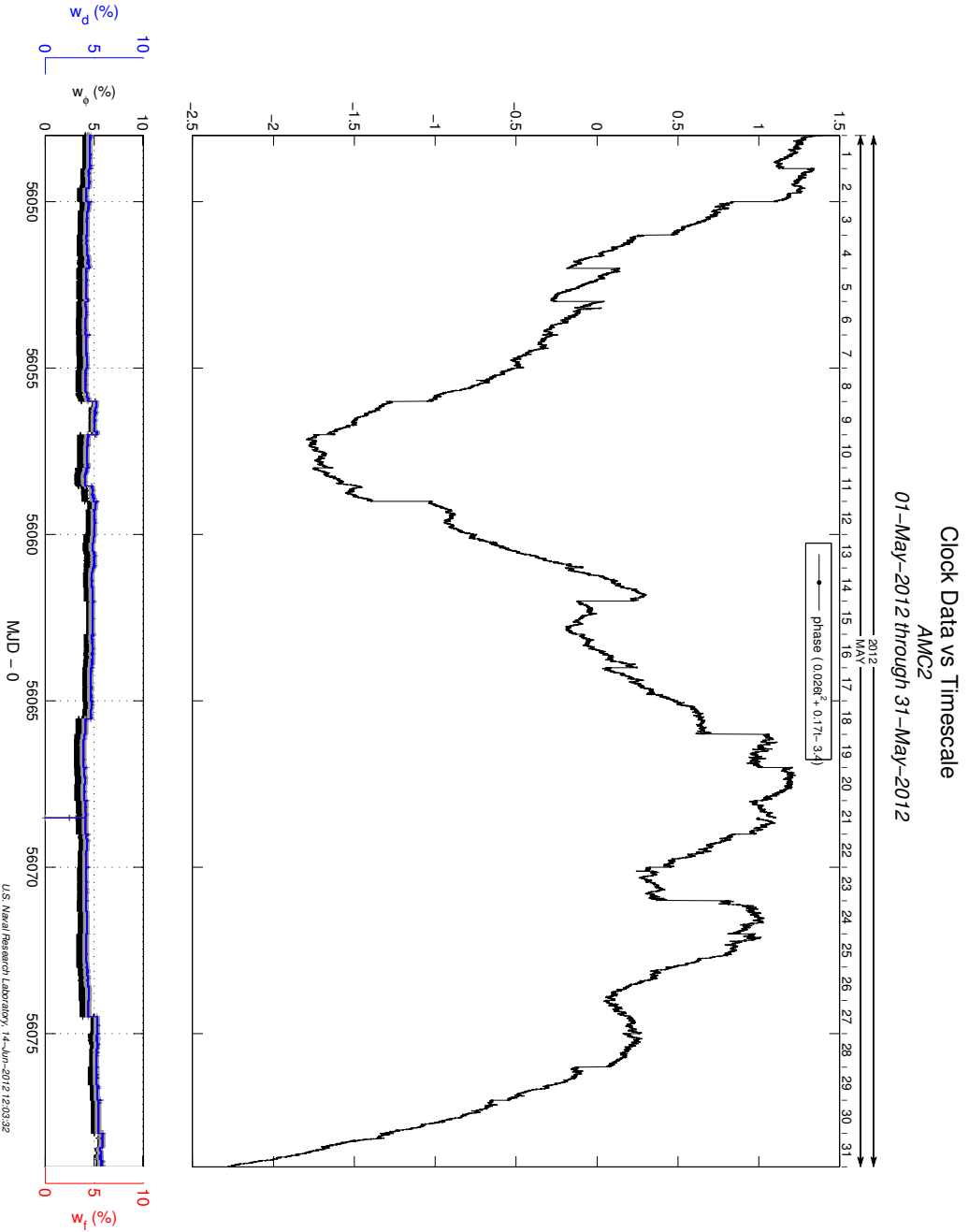

Figure 11: Sample “data vs timescale” plot showing the timescale input phase data for the clock at AMC2 referenced to the timescale IGS1 for May 2012. These phase “data” plots differ from the phase estimates as they include measurement noise but also since a clock may not be in steady-state within the filter because the clock is new or has undergone a reset.

EDITOR

AIUB Astronomical Institute
University of Bern

FOR MORE INFORMATION

IGS Central Bureau
Jet Propulsion Laboratory
M/S 238-540
48 Oak Grove Rd.
PASADENA, CA 91109 USA



www.igs.org
cb@igs.org

IGS IS A SERVICE OF



International Association of Geodesy
International Union of Geodesy and Geophysics



International Council for Science
World Data System